

collection 2020

it / ru

ACQUA DI CIELO E LUNAR GLASS

УВАЖАЕМЫЕ ПАРТНЕРЫ,
ЗАКАЗ ИЗДЕЛИЙ В НОВЫХ ОТДЕЛКАХ ВОЗМОЖЕН ТОЛЬКО ПРИ НАЛИЧИИ
ХОТЯ БЫ ОДНОЙ КОМПОЗИЦИИ В ДАННЫХ ЦВЕТАХ НА ЭКСПОЗИЦИИ !!!

hand made — in Italy.

cielo

LE ACQUE DI CIELO

**ALGA, ANEMONE, CORALLO,
NINFEA, OLTREMARE, SMERALDO**

cielo

LE ACQUE DI CIELO

Alga, Anemone, Corallo, Ninfea, Oltremare, Smeraldo.

Raccontare: così come con le parole, anche con i colori. Ceramica Cielo presenta “Le Acque di Cielo”, una collezione di tonalità intense, ispirate ancora una volta alla natura, ma caratterizzate da riflessi lucidi. Questa nuova palette glossy si affianca alle cromie matt esistenti de “Le Terre di Cielo”, permettendo di creare nuove suggestioni e dunque nuovi racconti.

Le possibilità di interpretazione sono notevoli, da un concetto più tradizionale e sobrio fino alla creazione di abbinamenti più audaci, che possano seguire tendenze, mode, non solo in ambito architettonico. Si possono quindi abbinare colori lucidi e colori opachi per lo stesso progetto. L’ambiente bagno così si svincola finalmente dalla sola idea di funzionalità ma si pone al pari degli altri ambienti della casa.

Alga - водоросли, Anemone - актиния, Corallo - коралл, Ninfea - кувшинка, Oltremare - морской горизонт, Smeraldo - изумруд. Создавать истории можно не только словами, но и цветами. Ceramica Cielo представляет “Le Acque di Cielo” - коллекцию глянцевых интенсивных оттенков, которые подсказала сама природа. Новая глянцевая палитра перекликается с существующими матовыми цветами “Le Terre di Cielo”, позволяя создавать новые комбинации, а значит и новые истории.

Возможности интерпретации очень широки, от более традиционной и трезвой концепции до создания смелых сочетаний, которые могут следовать тенденциям и моде не только в архитектурной среде. Можно комбинировать глянцевые и матовые цвета в одном проекте. Таким образом, понятие функциональности перестает быть единственным критерием для ванной комнаты, и она становится на один уровень с другими помещениями дома.

INTRODUZIONE

ВСТУПЛЕНИЕ

06

AVASO PRODOTTI & FINITURE

ПРОСЧЕТ ИЗДЕЛИЙ И ОТДЕЛОК

94

LISTINO PREZZI

ПРАЙС-ЛИСТ

126

I CATINI

10

LE BACINELLE

48

PLINIO

66

SPECCHI & ACCESSORI

ЗЕРКАЛА И АКСЕССУАРЫ

82

Cielo condivide le sue radici e la sua storia con l'arte ceramica italiana, nascendo in un territorio artisticamente fertile dove la qualità ha avuto qualcosa di più, qualcosa di diverso rispetto al resto del mondo. La duttilità, l'immediatezza e la bravura di maestri ceramisti nel corso dei secoli ha conquistato artisti, affinando abilità, conoscenze e competenze che Cielo ha portato nel suo mondo, quello dell'industria sanitaria. Qui dove la produzione della ceramica risale al X secolo A.C, Cielo è riuscita, con tenacia e determinazione, a trasmettere "quell'anima calda" di cui la ceramica artistica italiana è portavoce, attraverso l'utilizzo di materie prime dalle alte caratteristiche, macchinari di ultima generazione e una continua sperimentazione.

Forme archetipe ed essenziali e colori ispirati alla natura sono i tratti distintivi di Ceramica Cielo, un mondo in cui l'alchimia tra la trasformazione dell'argilla e un design contemporaneo e funzionale, crea qualcosa di unico.

IL LABORATORIO DELLA CERAMICA МАСТЕРСКАЯ КЕРАМИКИ

Corни и история Cielo неразрывно связаны с керамическим искусством Италии. Фабрика появилась на художественно плодородной территории, где качество имело особенное и более глубокое значение, чем где-либо в мире. Пластичность, стиль и умение итальянские керамисты оттачивали веками, превратив ремесло в искусство, а Cielo перенесли это мастерство в отрасль сантехники. В районе Витербо производство керамики началось в 10 веке до нашей эры, и Cielo удалось передать часть души и характера

художественной итальянской керамики в своих изделиях, используя высококачественное сырье, оборудование последнего поколения, непрерывно совершенствуясь и экспериментируя.

Фундаментальные формы и цвета, вдохновленные природой, являются отличительной чертой Ceramica Cielo, мира, в котором алхимия между преобразованием глины и современным функциональным дизайном создает нечто уникальное.



INTRODUZIONE
ВСТУПЛЕНИЕ

**Nuovi canoni e nuove visioni nascono attraverso *“Le Acque di Cielo”*.
Gli intensi colori che traggono ispirazione dalla natura - Alga, Anemone, Ninfea, Corallo, Oltremare e Smeraldo - donano nuove sfumature interpretative alla collezione de *“I Catini”*. Le forme pure ed essenziali delle strutture metalliche e della ceramica sono rafforzate da questa nuova finitura lucida, capace di dialogare con le decise geometrie dei piani, disponibili in pietra Azul Noche o nelle nuove tinte, ma anche con le venature dei contenitori in essenza che possono essere selezionati in alternativa.**

Gli stessi riflessi de *“Le Acque”* possono essere ritrovati sulle strutture degli specchi contenitori - Round Box, Oval Box, Tall Box e Simple Box - sui sanitari - Era, Enjoy e Smile - ed, infine, sugli accessori.

L'ambiente bagno trova dunque, in tutto il suo insieme, una nuova narrazione e la chiave di lettura ne è il colore.

Новые каноны и видение рождаются с помощью *“Le Acque di Cielo”*. Интенсивные цвета, вдохновленные природой - Alga, Anemone, Ninfea, Corallo, Oltremare и Smeraldo - придают свежие смыслы коллекции I Catini. Новое глянцевое покрытие подчеркивает четкость и чистоту форм керамики и металлических структур, хорошо сочетается со строгой геометрией полок крашенных в тон или вырезанных из гранита Azul Noche, подходит под шпонированные ящики.

В цветах *“Le Acque”* можно заказать зеркальные шкафчики - Round Box, Oval Box, Tali Box и Simple Box – сантехнику - Era, Enjoy и Smile, и наконец аксессуары.

Ванная комната приобретает новый облик, и ключ к его интерпретации - это цвет.

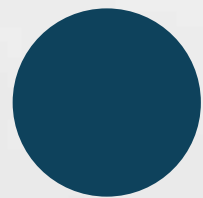

OLTREMARE

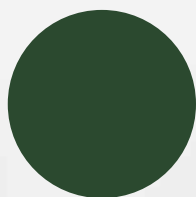

ALGA



SMERALDO

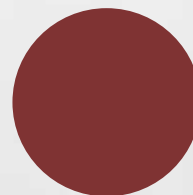

CORALLO

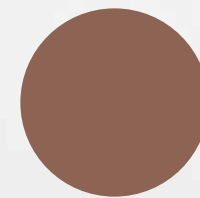

NINFEA

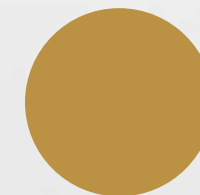

ANEMONE



Il Catino Tondo si presenta con lavabo Ninfea e struttura Corallo, in una suggestione bicromatica interrotta dal ripiano in pietra Azul Noche abbinato. Il resto dell'ambiente, caratterizzato dallo specchio Round Box e dai sanitari Enjoy, viene proposto sempre nella tonalità calda della palette, Corallo: più intenso e deciso. Come accessorio troviamo un portasapone con profilo nero e un ripiano in Ninfea.

Catino Tondo представлена с раковиной Ninfea и структурой в цвете Corallo, дизайн два цветакоторой прерван полочкой из камня Azul Noche. Интерьер дополняет зеркало Round Box и сантехника коллекции Enjoy в теплом оттенке палитры - Corallo: более ярком и активном. В качестве аксессуара предлагаем мыльницу с черным профилем и вставкой в цвете Ninfea.

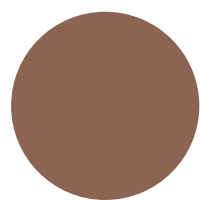

NINFEA

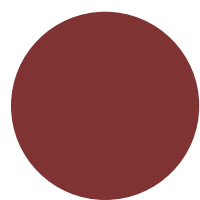

CORALLO

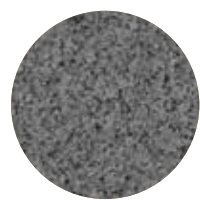

PIETRA AZUL
NOCHE



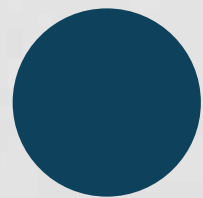

OLTREMARE

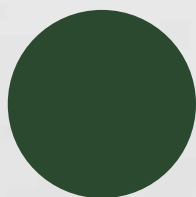

ALGA

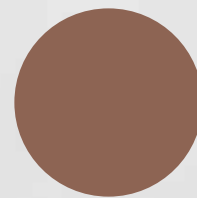

NINFEA

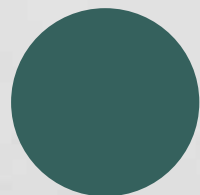

SMERALDO

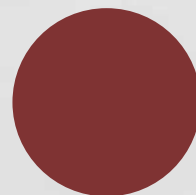

CORALLO

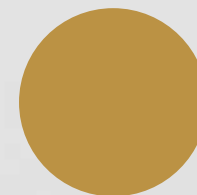

ANEMONE



Il Catino Ovale propone il lavabo color Anemone in abbinamento alla struttura Nero Matt insieme con il cassetto in Rovere Sbiancato. I sanitari Era sono a loro volta caratterizzati dalla tonalità Anemone. Lo specchio contenitore Oval Box e gli accessori - Mensola Porta Sapone e Porta Salviette - trovano invece continuità con la finitura Nero Matt della struttura metallica del Catino.

Catino Ovale с раковиной в цвете Анемоне, черной матовой структурой и ящиком в отделке из выбеленного дуба Rovere Sbiancato. Сантехника Era в цвете Анемоне. Зеркальный шкафчик Oval Box и аксессуары – мыльница и полотенцедержатель с черным матовым покрытием в тон металлической структуре раковины.

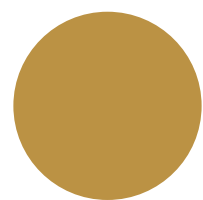

ANEMONE



ROVERE
SBIANCATO



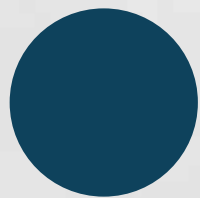

OLTREMARE

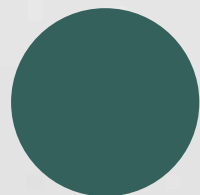

SMERALDO



ALGA

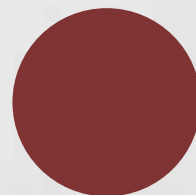

CORALLO

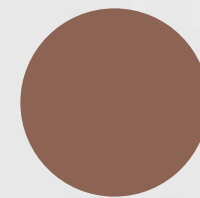

NINFEA

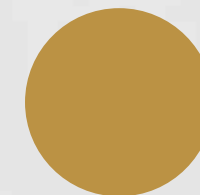

ANEMONE



Il Catino Doppio è proposto con il doppio lavello in Oltremare, la struttura Nero Matt e un ripiano in Rovere Sbiancato. La “profondità” di Oltremare si ritrova anche sui sanitari Era, pensati a contrasto con il bianco della vasca Dafne. Il grande specchio Round con gli accessori in Nero Matt completano l’ambiente bagno.

Catino Doppio с двойной раковиной в цвете Oltremare, структурой Matt Black и полочкой в отделке из выбеленного дуба Rovere Sbiancato. Глубокий цвет Oltremare здесь повторяется в сантехнике серии Era и создает контраст белой ванне Dafne. Большое круглое зеркало Round и аксессуары матового черного цвета дополняют интерьер ванной комнаты.

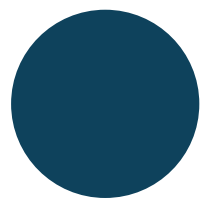

OLTREMARE



ROVERE
SBIANCATO





OLTREMARE

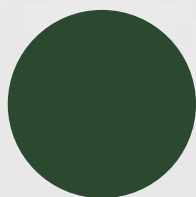

ALGA

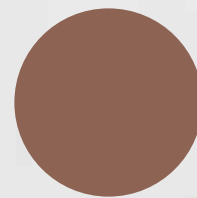

NINFEA

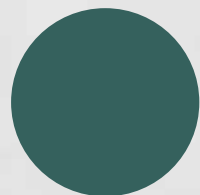

SMERALDO

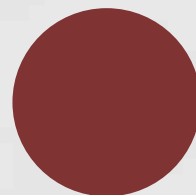

CORALLO

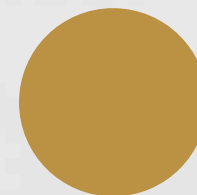

ANEMONE



Il Catino Rettangolare di colore Corallo poggia il suo ampio bacino sulla struttura color Nero Matt mentre la finitura del cassetto è Eucalipto. A completamento dell'ambiente sono stati inseriti un piano in pietra Azul Noche, lo specchio contenitore Tall Box e il pouf contenitore Otto di colore bianco.

Большая раковина финиш Corallo Catino Rettangolare размещена на структуре цвета Nero Matt, ящик в шпоне эвкалипта Eucalipto. Для завершения композиции добавлена плоскость из камня Azul Noche, зеркальный шкафчик Tall Box и пуф-контейнер Otto белого цвета.

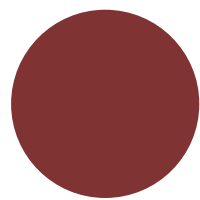

CORALLO



EUCALIPTO



I CATINI

CATINO TONDO
CATINO OVALE
CATINO DOPPIO
CATINO RETTANGOLARE

DESIGN ANDREA PARISIO
GIUSEPPE PEZZANO



**Una geometria pura che si adatta a qualsiasi forma e dimensione di spazio.
“Cercavamo oggetti ricchi di significato... applicando il filtro della contemporaneità
volevamo raccontare la bellezza della memoria”.**

CATINO TONDO

Чистая геометрия, которая адаптируется к любой форме и размеру пространства. “Мы искали объекты, богатые смыслом... применяя фильтр современности, мы хотели передать красоту истории”.

**L'ambiente bagno trova una nuova narrazione,
e la chiave di lettura ne è il colore.**

**Ванная комната приобретает новый облик,
и ключ к его интерпретации - это цвет.**



Catino Tondo - lavabo e piano in ceramica: finitura Anemone; struttura: finitura Anemone.

Specchio Oval Box: finitura Anemone. Pouff Otto Tondo in LivingTec: finitura Bianco Matt. Mensola tonda: finitura Nero Matt con piano in vetro.

Catino Tondo – раковина и полочка из керамики в отделке Анемоне, структура в отделке Анемоне. Зеркало Oval Box в отделке Анемоне.

Пуф Otto круглый из материала LivingTec в отделке белый матовый. Полочка круглая стеклянная, металл в отделке Nero Matt.



Catino Tondo - lavabo in ceramica, struttura: finitura Anemone; piano in pietra Azul Noche.

Specchio Oval Box: finitura Anemone. Pouff Otto Tondo in LivingTec: finitura Bianco Matt. Mensola tonda: finitura Nero Matt con piano in vetro.

Catino Tondo – раковина из керамики, структура в отделке Анемоне; полочка из гранита Azul Noche. Зеркало Oval Box в отделке Анемоне.

Пуф Otto круглый из материала LivingTec в отделке белый матовый. Полочка круглая стеклянная, металл в отделке Nero Matt.



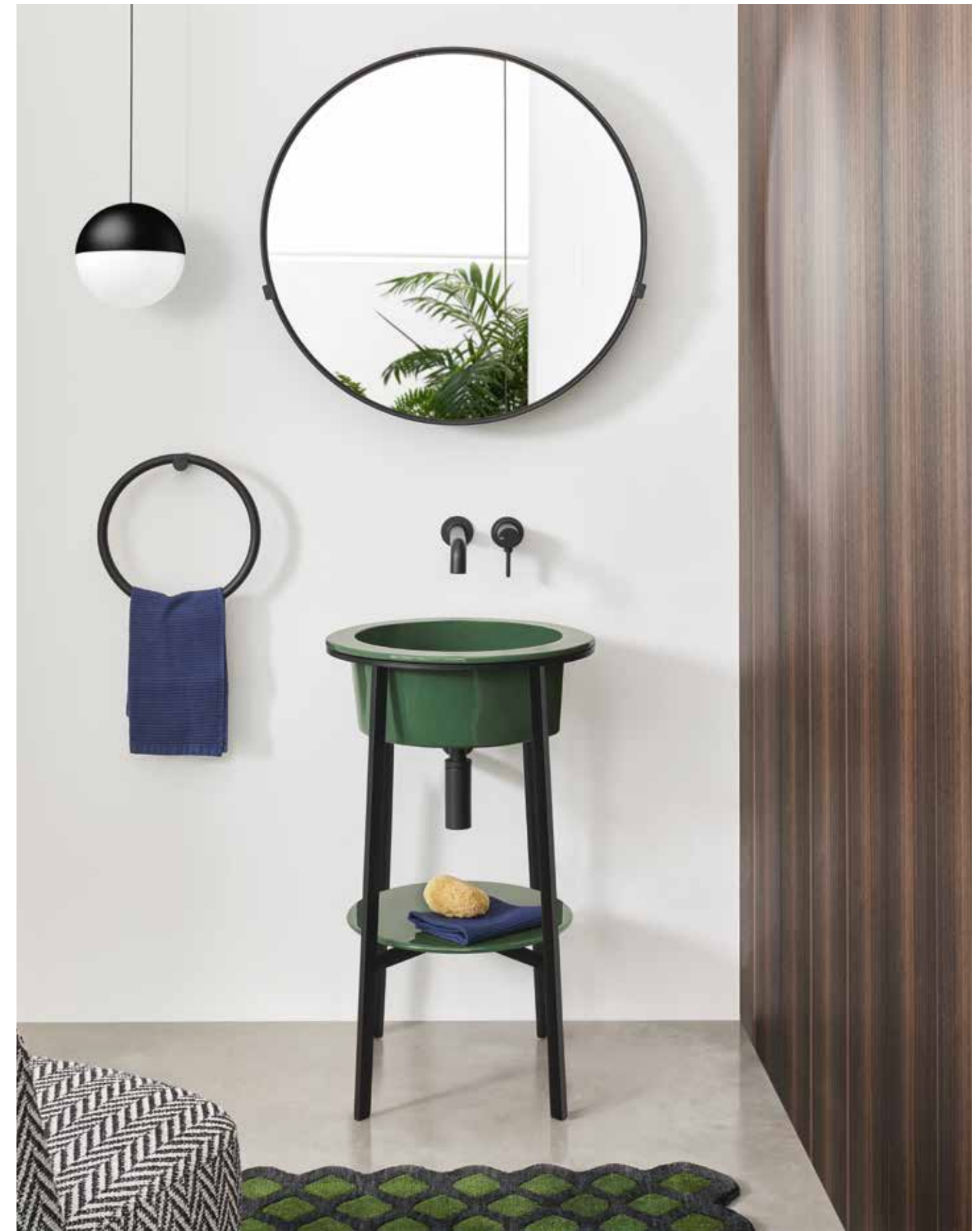

P. 18-19 Catino Tondo - lavabi e piani in ceramica: finiture Anemone e Alga; strutture: finitura Nero Matt.
 Specchi Simple Tall Box: finitura Nero Matt. Mensola tonda e ovale: finitura Nero Matt con piano in pietra Azul Noche.

Catino Tondo – раковина и полочка из керамики в отделке Анемоне и Alga, структура в отделке Nero Matt.
 Зеркала Simple Tall Box в отделке Nero Matt. Полочка круглая и овальная в отделке Nero Matt с полочкой из гранита Azul Noche.

Catino Tondo - lavabo e piano in ceramica: finitura Alga; struttura: finitura Nero Matt.
 Specchio Round Box 75: finitura Nero Matt. Portasciugamani ad anello: finitura Nero Matt.

Catino Tondo – раковина и полочка из керамики в отделке Alga, структура в отделке Nero Matt.
 Зеркало Round Box 75 в отделке Nero Matt. Полотенцедержатель-кольцо в отделке Nero Matt.



Catino Tondo - lavabo in ceramica: finitura Alga; struttura: finitura Nero Matt; piano in pietra Azul Noche.
Specchio Simple Tall Box: finitura Nero Matt. Portasciugamani ad anello: finitura Nero Matt. Mensola tonda: finitura Nero Matt con piano in vetro.

Catino Tondo – раковина из керамики в отделке Alga, структура в отделке Nero Matt, полочка из гранита Azul Noche.
Зеркало Simple Tall Box в отделке Nero Matt. Полотенцедержатель-кольцо в отделке Nero Matt. Полочка круглая стеклянная, металл в отделке Nero Matt.



L'ampio bacino dal disegno ellittico è la sintesi perfetta di eleganza e funzionalità. “Abbiamo voluto realizzare dei prodotti che valorizzassero l'anima artigianale dell'azienda, la sua vocazione a proporre oggetti che fossero la dimostrazione dell'eccellenza nella lavorazione della ceramica, che solo Cielo ha”.

CATINO OVALE

Большая раковина эллиптической формы - идеальное сочетание элегантности и функциональности. “Мы хотели создавать изделия, подчеркивающие ценность нашего мануфактурного производства, демонстрирующие совершенство обработки керамики, которое присуще только Cielo”.



Catino Ovale - lavabo in ceramica: finitura Oltremare; struttura: finitura Oltremare; piano in ceramica: finitura Smeraldo. Specchio Oval Box: finitura Smeraldo.
Portasciugamani ad anello: finitura Nero Matt. Mensola tonda: finitura Nero Matt con piano in vetro.

Catino Ovale – раковина из керамики в отделке Oltremare, структура в отделке Oltremare, полочка из керамики в отделке Smeraldo.
Зеркало Oval Box в отделке Smeraldo. Полотенцедержатель-кольцо в отделке Nero Matt. Полочка круглая стеклянная, металл в отделке Nero Matt.

Alga, Anemone, Ninfea, Corallo, Oltremare, Smeraldo donano nuove sfumature alla collezione “I Catini”.

Alga, Anemone, Ninfea, Corallo, Oltremare, Smeraldo придают новые смыслы коллекции “I Catini”.



Catino Ovale - lavabo e piano in ceramica: finitura Smeraldo; struttura: finitura Smeraldo. Specchio Simple Tall Box: finitura Nero Matt.

Portasciugamani ad anello: finitura Nero Matt. Mensola tonda: finitura Nero Matt con piano in vetro.

Catino Ovale – раковина и полочка из керамики в отделке Smeraldo, структура в отделке Smeraldo. Зеркало Simple Tall Box в отделке Nero Matt.

Полотенцедержатель-кольцо в отделке Nero Matt. Полочка круглая стеклянная, металл в отделке Nero Matt.



Catino Ovale - lavabo e piano in ceramica: finitura Smeraldo; struttura: finitura Smeraldo.
Specchio Round Box 75: finitura Anemone. Mensola ovale: finitura Nero Matt con piano in vetro.

Catino Ovale – раковина и полочка из керамики в отделке Smeraldo, структура в отделке Smeraldo.
Зеркало Round Box 75 в отделке Анемоне. Полочка овальная стеклянная в отделке Nero Matt.



Catino Ovale - lavabo in ceramica: finitura Smeraldo; struttura: finitura Cemento; piano in pietra Azul Noche.
Specchio Oval Box: finitura Smeraldo. Portasciugamani ad anello: finitura Nero Matt.

Catino Ovale – раковина из керамики в отделке Smeraldo, структура в отделке Cemento, полочка из гранита Azul Noche.
Зеркало Oval Box в отделке Smeraldo. Полотенцедержатель-кольцо в отделке Nero Matt.





P. 34-35 Catino Ovale - lavabo in ceramica: finitura Smeraldo; struttura: finitura Cemento; piano in pietra Azul Noche.
 Specchio Oval Box: finitura Smeraldo. Portasciugamani ad anello: finitura Nero Matt. Wc e Bidet Smile a terra: finitura Smeraldo.
 Portasciugamani ovale 30: finitura Nero Matt.

Catino Ovale – раковина из керамики в отделке Smeraldo, структура в отделке Cemento, полочка из гранита Azul Noche.
 Зеркало Oval Box в отделке Smeraldo. Полотенцедержатель-кольцо в отделке Nero Matt. Smile унитаз и Биде напольные в отделке Smeraldo.
 Полотенцедержатель овальный 30 в отделке Nero Matt.

Wc e bidet sospesi Era: finitura Ninfea. Portasciugamani ovale 30: finitura Nero Matt. Portarotolo: finitura Nero Matt.
 Portascopino: finitura Nero Matt con piano in vetro.

Era унитаз и биде подвесные в отделке Ninfea. Полотенцедержатель овальный 30 в отделке Nero Matt.
 Бумагодержатель в отделке Nero Matt. Туалетный ершик в отделке Nero Matt со стеклянной полочкой.



Wc e bidet sospesi Enjoy 53: finitura Corallo. Portasciugamani ovale 30: finitura Nero Matt.
Portarotolo: finitura Nero Matt. Portascopino: finitura Nero Matt con piano in vetro.

Enjoy 53 унитаз и биде подвесные в отделке Corallo. Полотенцедержатель овальный 30 в отделке Nero Matt.
Бумагодержатель в отделке Nero Matt. Туалетный ершик в отделке Nero Matt со стеклянной полочкой.



Unico elemento con uno o due bacini dove la diversità delle finiture esalta la bellezza della forma.

I lavabi in ceramica nei colori delle Acque di Cielo, supportate da strutture metalliche nelle finiture Nero Matt, Cemento o nella gamma delle Acque, possono essere integrati da piani in essenza o in pietra oppure da un comodo cassetto contenitore.

CATINO DOPPIO CATINO RETTANGOLARE

Единая столешница, с одной или двумя раковинами, разнообразие отделок которой подчеркивают истинную красоту формы.

Раковины из керамики в отделке Acque di Cielo, размещенные на металлических структурах в отделке Nero Matt, Cemento или Acque di Cielo, можно сочетать с полочкой из камня или в шпоне, либо с удобным ящиком.



Catino Doppio - lavabo in ceramica: finitura Corallo; struttura: finitura Nero Matt; piano in pietra Azul Noche.
 Specchio Round Box 90: finitura Corallo. Portasciugamani ad anello: finitura Nero Matt. Mensola ovale: finitura Nero Matt con piano in pietra Azul Noche.

Catino Doppio – раковина из керамики в отделке Corallo, структура в отделке Nero Matt, полочка из гранита Azul Noche.
 Зеркало Round Box 90 в отделке Corallo. Полотенцедержатель-кольцо в отделке Nero Matt. Полочка овальная из гранита Azul Noche, металл в отделке Nero Matt.

Le possibilità di interpretazione sono notevoli, da un concetto più tradizionale e sobrio fino alla creazione di abbinamenti più audaci, che possano seguire tendenze, mode, non solo in ambito architettonico.

Возможности интерпретации безграничны, от более традиционной и трезвой концепции до создания смелых комбинаций, которые могут следовать тенденциям, моде не только в архитектурной сфере.

Catino Rettangolare - lavabo in ceramica: finitura Ninfea; struttura: finitura Nero Matt; piano in pietra Azul Noche.

Specchio Simple Tall Box: finitura Nero Matt. Portasciugamani ovale 30: finitura Nero Matt.

Catino Rettangolare – раковина из керамики в отделке Ninfea, структура в отделке Nero Matt, полочка из гранита Azul Noche.

Зеркало Simple Tall Box в отделке Nero Matt. Полотенцедержатель овальный 30 в отделке Nero Matt.





Catino Rettangolare - lavabo in ceramica: finitura Ninfea; struttura: finitura Ninfea; cassetto: finitura Rovere Sbiancato.
Specchio Round Box 90: finitura Corallo. Portasciugamani ad anello: finitura Nero Matt. Mensola ovale: finitura Nero Matt con piano in vetro.

Catino Rettangolare – раковина из керамики в отделке Ninfea, структура в отделке Ninfea, ящик в отделке Rovere Sbiancato. Зеркало Round Box 90 в отделке Corallo. Полотенцедержатель-кольцо в отделке Nero Matt. Полочка овальная в отделке Nero Matt со стеклянной полочкой.



LE BACINELLE

TINO E TINA

DESIGN ANDREA PARISIO
GIUSEPPE PEZZANO

ERA / ERA SMALL
ECO / ECO SMALL
HANDY

DESIGN LUCA CIMARRA

SHUI
SHUI COMFORT
MINIMO





Bacinelle Era Small: finiture Corallo, Ninfea, Smeraldo. Specchio Round Box 75: finitura Anemone.

Era Small раковина в отделке Corallo, Ninfea, Smeraldo. Зеркало Round Box 75 в отделке Anemone.



Bacinella Era Small: finitura Corallo. Bacinella Era Small: finitura Ninfea.
Era Small раковина в отделке Corallo. Era Small раковина в отделке Ninfea.



P. 56-57 Bacinelle Shui 40: finitura Anemone. Specchio Round Box 75: finitura Anemone.
Shui 40 раковина в отделке Anemone. Зеркало Round Box 75 в отделке Anemone.





Bacinelle Tino: finiture Alga e Oltremare. Specchi Simple Tall Box: finitura Nero Matt.

Portasciugamani rettangolare 30: finitura Nero Matt. Mensola tonda: finitura Nero Matt con piano in pietra Azul Noche.

Tino раковина в отделке Alga и Oltremare. Зеркала Simple Tall Box в отделке Nero Matt.

Полотенцедержатель прямоугольный 30 в отделке Nero Matt. Полочка круглая из гранита Azul Noche, металл в отделке Nero Matt.





Lavabo Shui Comfort rettangolare monoforo: finitura Smeraldo. Specchio Round Box 75: finitura Nero Matt.

Shui Comfort раковина прямоугольная с 1 отв. под смеситель, в отделке Smeraldo. Зеркало Round Box 75 в отделке Nero Matt.



Lavabo Shui Comfort rettangolare: finitura Oltremare. Specchio Oval Box: finitura Smeraldo. Portasciugamani ad anello: finitura Nero Matt.

Shui Comfort раковина прямоугольная в отделке Oltremare. Зеркало Oval Box в отделке Smeraldo. Полотенцедержатель-кольцо в отделке Nero Matt.

Bacinella Eco Small: finitura Oltremare. Specchio Pluto: finitura Nero Matt.

Eco Small раковина в отделке Oltremare. Зеркало Pluto в отделке Nero Matt.



PLINIO

PLINIO

DESIGN ANDREA PARISIO
GIUSEPPE PEZZANO



Plinio 115 - lavabo in ceramica: finitura Talco; struttura: finitura Nero Matt; cassetto in finitura Rovere Nero; cesta in cuoio h10: finitura Bianco Matt.

Specchio Oval Box: finitura Ninfea. Portasciugamani ad anello: finitura Nero Matt. Mensola ovale: finitura Nero Matt con piano in vetro.

Plinio 115 – раковина из керамики в отделке Talco, структура в отделке Nero Matt, ящик в отделке Rovere Nero; Корзина из кожи h10: отделке белый матовый.

Зеркало Oval Box в отделке Ninfea. Полотенцедержатель-кольцо в отделке Nero Matt. Полочка овальная стеклянная, металл в отделке Nero Matt.



P. 72-73 Plinio 85 - lavabo in ceramica: finitura Talco; struttura: finitura Nero Matt; cassetto: finitura Rovere Sbiancato.
Specchio Simple Tall Box: finitura Nero Matt. Portasciugamani ovale 30: finitura Nero Matt. Mensola tonda: finitura Nero Matt con piano in vetro.

Plinio 85 – раковина из керамики в отделке Talco, структура в отделке Nero Matt, ящик в отделке Rovere Sbiancato.
Зеркало Simple Tall Box в отделке Nero Matt. Полотенцедержатель овальный 30 в отделке Nero Matt. Полочка круглая стеклянная, металл в отделке Nero Matt.



**Si possono abbinare colori lucidi e colori opachi per lo stesso progetto.
L'ambiente bagno così si svincola finalmente dalla sola idea di funzionalità
ma si pone al pari degli altri ambienti della casa.**

**Можно комбинировать глянцевые и матовые цвета в одном проекте.
Таким образом, понятие функциональности перестает быть единым
критерием для ванной комнаты, и она становится на один уровень с
другими помещениями дома.**



Plinio 85 - lavabo in ceramica: finitura Lavagna; struttura: finitura Nero Matt; piano in finitura Rovere Nero; cesta in cuoio naturale.
Specchio Round Box 75: finitura Nero Matt. Portasciugamani ovale 30: finitura Nero Matt. Mensola ovale: finitura Nero Matt con piano in vetro.

Plinio 85 – раковина из керамики в отделке Lavagna, структура в отделке Nero Matt, полочка в отделке Rovere Nero, корзина из кожи в отделке naturale.
Зеркало Round Box 75 в отделке Nero Matt. Полотенцедержатель овальный 30 в отделке Nero Matt. Полочка овальная стеклянная, металл в отделке Nero Matt.

Plinio 85 - lavabo in ceramica: finitura Pomice. Specchio Round Box 75: finitura Nero Matt.

Plinio 85 – раковина из керамики в отделке Pomice. Зеркало Round Box 75 в отделке Nero Matt.

P. 78-79 Plinio 85 - lavabo in ceramica: finitura Lavagna. Specchio Round Box 75: finitura Anemone. Portasciugamani rettangolare 60: finitura Nero Matt.

Plinio 85 – раковина из керамики в отделке Lavagna. Зеркало Round Box 75 в отделке Анемоне. Полотенцедержатель прямоугольный 60 в отделке Nero Matt.







Plinio 85 - lavabo in ceramica: finitura Lavagna. Specchio Round Box 75: finitura Anemone. Portasciugamani rettangolare 60: finitura Nero Matt.

Plinio 85 – раковина из керамики в отделке Lavagna. Зеркало Round Box 75 в отделке Анемоне. Полотенцедержатель прямоугольный 60 в отделке Nero Matt.

SPECCHI

&

ACCESSORI

**ROUND BOX
OVAL BOX
SIMPLE BOX
SIMPLE TALL BOX**

**DESIGN ANDREA PARISIO
GIUSEPPE PEZZANO**

Insieme di accessori.

Набор аксессуаров





Specchio Simple Tall Box: finitura Nero Matt. Mensole tonda e ovale: finitura Nero Matt con piano in pietra Azul Noche.

Зеркало Simple Tall Box в отделке Nero Matt. Полочка круглая и овальная, из гранита Azul Noche, металл в отделке Nero Matt.





Portascopino: finitura Nero Matt con piano in vetro. Mensola ovale: finitura Nero Matt con piano in pietra Azul Noche. Specchio Round Box 90: finitura Corallo.

Туалетный ершик в отделке Nero Matt со стеклянной полочкой. Полочка овальная, из гранита Azur Noche, металл в отделке Nero Matt.
Зеркало Round Box 90 в отделке Corallo.



Specchio Oval Box: finitura Anemone. Mensola tonda: finitura Nero Matt con piano in vetro.

Зеркало Oval Box в отделке Анемоне. Полочка круглая стеклянная, металл в отделке Nero Matt.

P. 92-93 Specchio Oval Box: finitura Smeraldo. Specchio Round Box: finitura Anemone.

Зеркало Oval Box в отделке Smeraldo. Зеркало Round Box в отделке Анемоне.



ABACO PRODOTTI & FINITURE
ПРОСЧЕТ ИЗДЕЛИЙ И ОТДЕЛОК

INDICE / INDEX

PRODOTTI DISPONIBILI NELLE FINITURE “LE ACQUE DI CIELO”
ИЗДЕЛИЯ ДОСТУПНЫЕ В ОТДЕЛКЕ “LE ACQUE DI CIELO”

I CATINI

Catino Tondo
Catino Ovale
Catino Doppio
Catino Rettangolare

PLINIO

DELFO

SANITARI

Era
Smile
Enjoy sospesa

MIROIRS / ЗЕРКАЛА

Round Box 75 / 90
Oval Box
Simple Box
Simple Tall Box

LE BACINELLE

Tino
Tina
Eco / Eco Small
Era / Era Small
Handy
Shui 40
Shui 45
Shui Comfort:
quadrato / квадрат
rettangolare / прямоугольный
tondo / круглый
ovale / Овал
monoforo rettangolare / прямоугольный одно отверстие под смеситель
monoforo tondo / круглый одно отверстие под смеситель
monoforo quadrato / квадрат одно отверстие под смеситель
Minimo quadrato / Минимо квадрат
Minimo tondo / Минимо круглый

ACCESSOIRES / АКЦЕССУАРЫ

INDICE / INDEX

I CATINI

Mobili con lavabo / мебель с умывальником

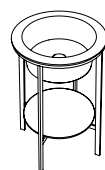

CATINO TONDO
con piano
Catino Tondo
с полочкой
столешница
cm Ø50 x 83 h
P. 138



CATINO OVALE
con piano
Catino Ovale
с полочкой столешни
cm 70 x 50 x 83 h
P. 140

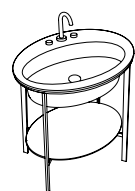

CATINO OVALE
monoforo predisposto
3 fori con piano
Керамическая
Catino Ovale
с полочкой столешница
cm 70 x 50 x 83 h
P. 141

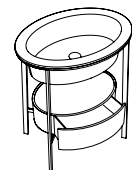

CATINO OVALE
con cassetto
Catino Ovale
с ящиком
cm 70 x 50 x 83 h
P. 140

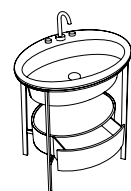

CATINO OVALE
monoforo predisposto
3 fori con cassetto
Керамическая
Catino Ovale с ящиком
cm 70 x 50 x 83 h
P. 141

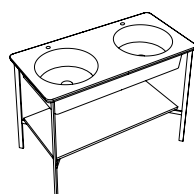

CATINO DOPPIO
con piano
Catino Doppio
с полочкой столешница
cm 110 x 58,5 x 83 h
P. 142

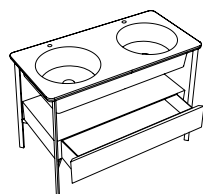

CATINO DOPPIO
con cassetto
Catino Doppio
с ящиком
cm 110 x 58,5 x 83 h
P. 142

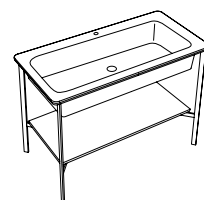

**CATINO
RETTANGOLARE**
con piano
Catino Rettangolare
с полочкой столешница
cm 110 x 58,5 x 83 h
P. 143

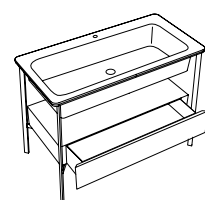

**CATINO
RETTANGOLARE**
con cassetto
Catino Rettangolare
с ящиком
cm 110 X 58,5 x 83 h
P. 143

PLINIO

Mobili con lavabo / мебель с умывальником

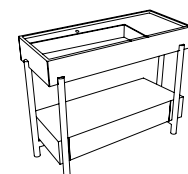

PLINIO 85
con cassetto
Plinio 85 с ящиком
cm 85 x 46 x 82,5 h
P. 150

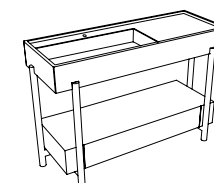

PLINIO 115
con cassetto
Plinio 115 с ящиком
cm 115 x 46 x 82,5 h
P. 150

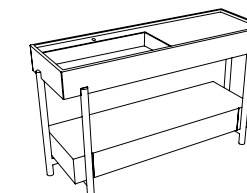

PLINIO 140
con cassetto
Plinio 140 с ящиком
cm 140 x 46 x 82,5 h
P. 150



CESTA IN CUOIO h10
Корзина из кожи h10
cm 63 x 36 x 10 h
P. 151

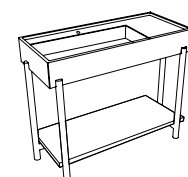

PLINIO 85
con piano
Plinio 85 с полочкой
столешница
cm 85 x 46 x 82,5 h
P. 150

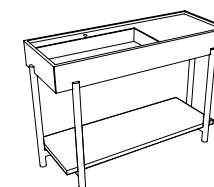

PLINIO 115
con piano
Plinio 115 с полочкой
столешница
cm 115 x 46 x 82,5 h
P. 150

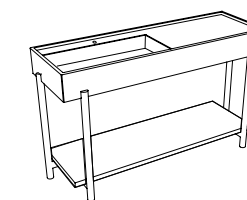

PLINIO 140
con piano
Plinio 140 с полочкой
столешница
cm 140 x 46 x 82,5 h
P. 150

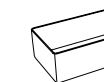

CESTA IN CUOIO h28
Корзина из кожи h28
cm 63 x 36 x 28 h
P. 151

DELFO

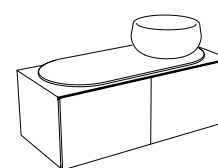

DELFO
mobile con ante frontali lisce
Тумба с передней дверцей
гладкий
cm 113 x 52 x 40 h
P. 146

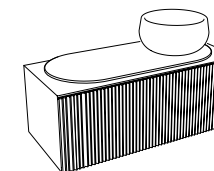

DELFO
mobile con ante frontali in listelli
di massello triangolari
Тумба с передней дверцей из
массива бруса треугольной формы
из натурального шпона дерева
cm 113 x 52 x 40 h
P. 146

LE BACINELLE

Lavabi / умывальники



TINA
Bacinella
бассейн
cm Ø45 x 26 h
P. 154



TINO
Bacinella
бассейн
cm Ø43 x 19 h
P. 154



ECO
Bacinella
бассейн
cm 62 x 45 x 18 h
P. 153



ECO SMALL
Bacinella
бассейн
cm 58 x 42 x 16,5 h
P. 153



ERA
Bacinella
бассейн
cm Ø45 x 24 h
P. 153



ERA SMALL
Bacinella
бассейн
cm Ø40 x 15 h
P. 153



HANDY
Bacinella monoforo
\ бассейн одно
отверстие под
смеситель
cm Ø45 x 16,8 h
P. 153

SHUI COMFORT

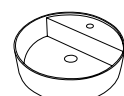

**TONDO
MONOFORO**
круглый одно
отверстие под
смеситель
cm Ø45 x 13 h
P. 156

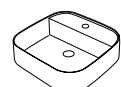

**QUADRATO
MONOFORO**
квадрат одно
отверстие под
смеситель
cm 44 x 43 x 13,5 h
P. 156

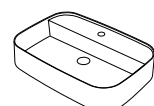

**RETTANGOLARE
MONOFORO**
прямоугольный
одно отверстие под
смеситель
cm 60 x 43 x 13 h
P. 156



TONDO
круглый
cm Ø40 x 12,5 h
P. 155



QUADRATO
квадрат
cm 40 x 40 x 12,5 h
P. 155

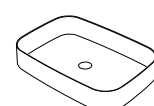

RETTANGOLARE
прямоугольный
cm 60 x 40 x 12,5 h
P. 155

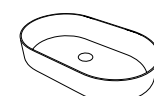

OVALE
Овал
cm 60 x 38 x 12,5 h
P. 155



**MINIMO
QUADRATO**
Minimo квадрат
cm 25 x 25 x 11,5 h
P. 155



**MINIMO
TONDO**
Minimo круглый
cm Ø25 x 11,5 h
P. 155

SHUI



SHUI 40
Bacinella
бассейн
cm Ø40 x 18,5 h
P. 154



SHUI 45
Bacinella
бассейн
cm Ø45 x 12,5 h
P. 154

ERA

Wc / Bidet

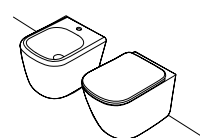

ERA
Wc e bidet a terra
унитаз и Биде напольное

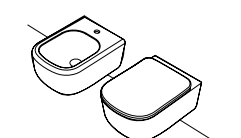

ERA
Wc e bidet sospesi
унитаз и Биде подвесное

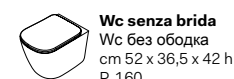

Wc senza brida
Wc без ободка
cm 52 x 36,5 x 42 h
P. 160



Wc senza brida
Wc без ободка
cm 53 x 36,5 x 30 h
P. 158

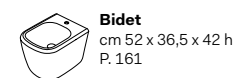

Bidet
cm 52 x 36,5 x 42 h
P. 161

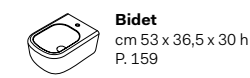

Bidet
cm 53 x 36,5 x 30 h
P. 159

SMILE

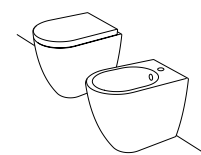

SMILE 48
Wc e bidet a terra
унитаз и Биде напольное

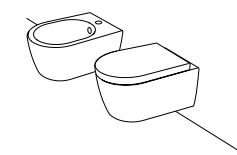

SMILE 48
Wc e bidet sospesi
унитаз и Биде подвесное

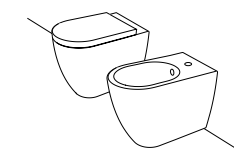

SMILE 53
Wc e bidet a terra
унитаз и Биде напольное

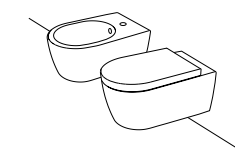

SMILE 53
Wc e bidet sospesi
унитаз и Биде подвесное

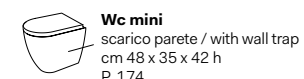

Wc mini
scarico parete / with wall trap
cm 48 x 35 x 42 h
P. 174

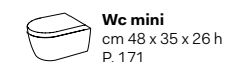

Wc mini
cm 48 x 35 x 26 h
P. 171

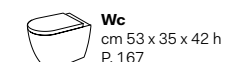

Wc
cm 53 x 35 x 42 h
P. 167

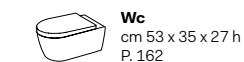

Wc
cm 53 x 35 x 27 h
P. 162

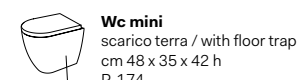

Wc mini
scarico terra / with floor trap
cm 48 x 35 x 42 h
P. 174

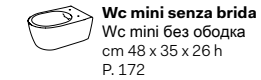

Wc mini senza brida
Wc mini без ободка
cm 48 x 35 x 26 h
P. 172

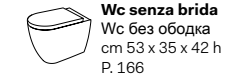

Wc senza brida
Wc без ободка
cm 53 x 35 x 42 h
P. 166

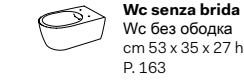

Wc senza brida
Wc без ободка
cm 53 x 35 x 27 h
P. 163



Bidet mini
cm 48 x 35 x 42 h
P. 175



Bidet mini
cm 48 x 35 x 26 h
P. 170

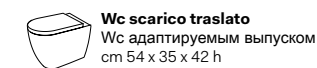

Wc scarico traslato
Wc адаптируемый выпуском
cm 54 x 35 x 42 h
P. 168

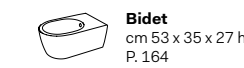

Bidet
cm 53 x 35 x 27 h
P. 164

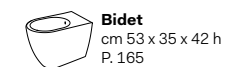

Bidet
cm 53 x 35 x 42 h
P. 165

ENJOY

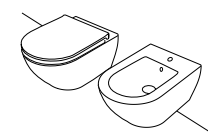

ENJOY 48
Wc e bidet sospesi
унитаз и Биде подвесное

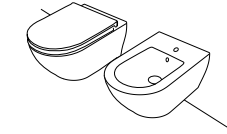

ENJOY 53
Wc e bidet sospesi
унитаз и Биде подвесное

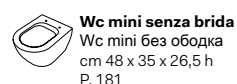

Wc mini senza brida
Wc mini без ободка
cm 48 x 35 x 26,5 h
P. 181

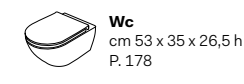

Wc
cm 53 x 35 x 26,5 h
P. 178

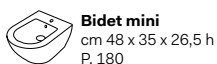

Bidet mini
cm 48 x 35 x 26,5 h
P. 180

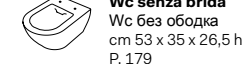

Wc senza brida
Wc без ободка
cm 53 x 35 x 26,5 h
P. 179

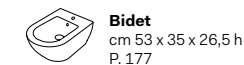

Bidet
cm 53 x 35 x 26,5 h
P. 177

Specchi / зеркала



ROUND BOX 75
Specchio contenitore 75
Зеркальный шкафчик 75
cm Ø75 x 12
P. 182

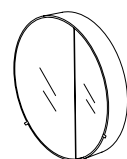

ROUND BOX 90
Specchio contenitore 90
Зеркальный шкафчик 90
cm Ø90 x 12
P. 182

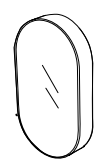

OVAL BOX
Specchio contenitore
Зеркальный шкафчик
cm 50 x 12 x 90 h
P. 182



SIMPLE TALL BOX
Specchio contenitore
Зеркальный шкафчик
cm 45 x 12 x 110 h
P. 182

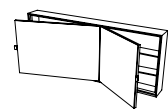

SIMPLE BOX
Specchio contenitore
Зеркальный шкафчик
cm 90 x 12 x 45 h
P. 182

Accessori / аксессуары



MENSOLA OVALE
Полочка овальная
cm 25 x 12 x 3 h
P. 184



MENSOLA TONDA
Полочка круглая
cm Ø 12 x 3 h
P. 184



DISPENSER IN METALLO
Диспенсер из металла
cm Ø6 x 18 h
P. 185



BICCHIERE IN METALLO
Стаканчик из металла
cm Ø6 x 11 h
P. 185



GANCIO 1
Крючок тип 1
cm Ø3 x 4
P. 185



GANCIO 2
Крючок тип 2
cm Ø3 x 4
P. 185



PORTASCIUGAMANI AD ANELLO
Полотенцедержатель-кольцо
cm Ø 32
P. 185



PORTASCIUGAMANI OVALE 30
Полотенцедержатель, овальный версия 30
cm 30 x 6 x 3 h
P. 185



PORTASCIUGAMANI OVALE 45
Полотенцедержатель, овальный версия 45
cm 45 x 6 x 3 h
P. 185

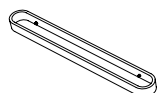

PORTASCIUGAMANI OVALE 60
Полотенцедержатель, овальный версия 60
cm 60 x 6 x 3 h
P. 185



PORTA ROTOLO
Держатель туалетной бумаги из металла
cm 12 x 10 x 3 h
P. 186

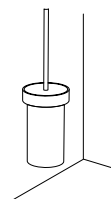

PORTASCOPINO SOSPESO
Ершик для унитаза настенный
cm Ø12 x 42 h
P. 186

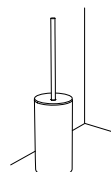

PORTASCOPINO DA TERRA
Ершик для унитаза напольный
cm Ø12 x 42 h
P. 187

MOBILI CON LAVABO DISPONIBILI NELLE FINITURE "LE ACQUE DI CIELO"
 МЕБЕЛЬ ДОСТУПНАЯ С РАКОВИНАМИ В ОТДЕЛКЕ "LE ACQUE DI CIELO"

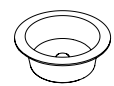

LAVABO / РАКОВИНА

CERAMICA / КЕРАМИЧЕСКАЯ



OLTREMARE



SMERALDO



ALGA



CORALLO



NINFEA



ANEMONE



PIANO / СТОЛЕШНИЦА

CERAMICA / КЕРАМИЧЕСКАЯ



OLTREMARE



SMERALDO



ALGA



CORALLO



NINFEA



ANEMONE



PIETRA / КАМЕНЬ

AZUL
NOCHE

STRUTTURA / КАРКАС

METALLO / МЕТАЛЛ



OLTREMARE



SMERALDO



ALGA



CORALLO



NINFEA



ANEMONE

NERO MATT
/ MATT BLACK

CEMENTO

CATINO TONDO

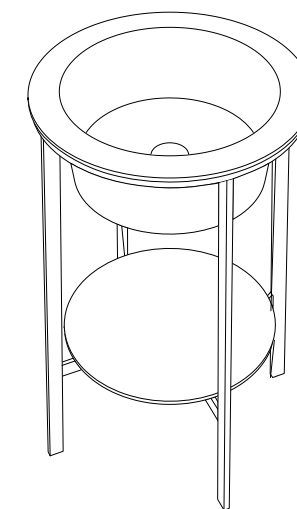

CATINO TONDO
 cm Ø50 x 83 h

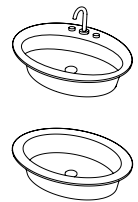

LAVABO / РАКОВИНА

CERAMICA / КЕРАМИЧЕСКАЯ



OLTREMARE



SMERALDO



ALGA



CORALLO



NINFEA



ANEMONE



PIANO / СТОЛЕШНИЦА

CERAMICA / КЕРАМИЧЕСКАЯ



OLTREMARE



SMERALDO



ALGA



CORALLO



NINFEA



ANEMONE

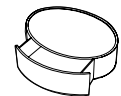

PIETRA / КАМЕНЬ

AZUL
NOCHE

CASSETTO / ЯЩИК

ESSENZA / ДЕРЕВО

ROVERE
NATURALEROVERE
SBIANCATOROVERE
GRIGIOROVERE
NERO

EUCALIPTO



STRUTTURA / КАРКАС

METALLO / МЕТАЛЛ



OLTREMARE



SMERALDO



ALGA



CORALLO



NINFEA



ANEMONE

NERO MATT
/ MATT BLACK

CEMENTO

CATINO OVALE

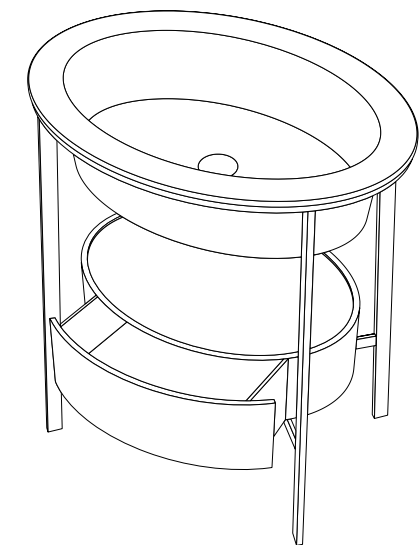
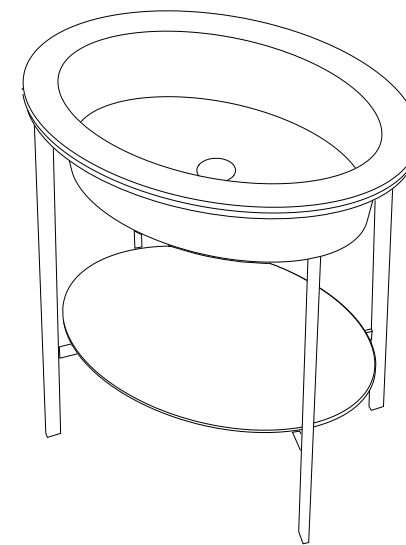

CATINO OVALE

con piano / с полочкой столешни

con cassetto / с ящиком

cm 70 x 50 x 83 h

CATINO OVALE MONOFORO

con piano / с полочкой столешни

con cassetto / с ящиком

cm 70 x 50 x 83 h

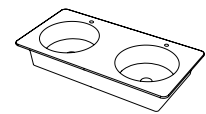

LAVABO / РАКОВИНА

CERAMICA / КЕРАМИЧЕСКАЯ



+



PIANO / СТОЛЕШНИЦА

ESSENZA / ДЕРЕВО



PIETRA / КАМЕНЬ

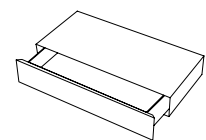

CASSETTO / ЯЩИК

ESSENZA / ДЕРЕВО



+

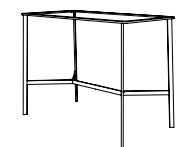

STRUTTURA / КАРКАС

METALLO / МЕТАЛЛ

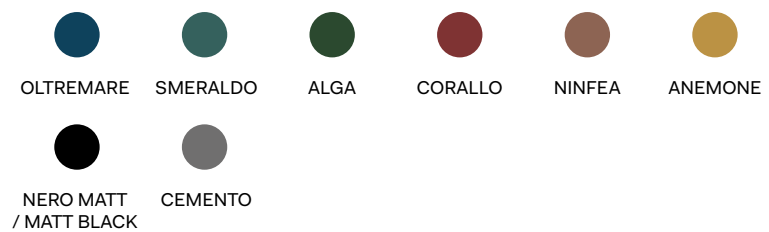

CATINO DOPPIO

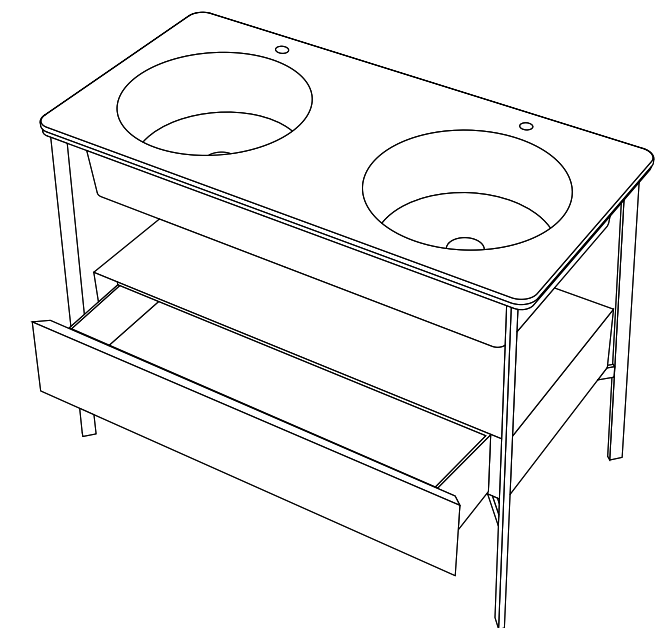
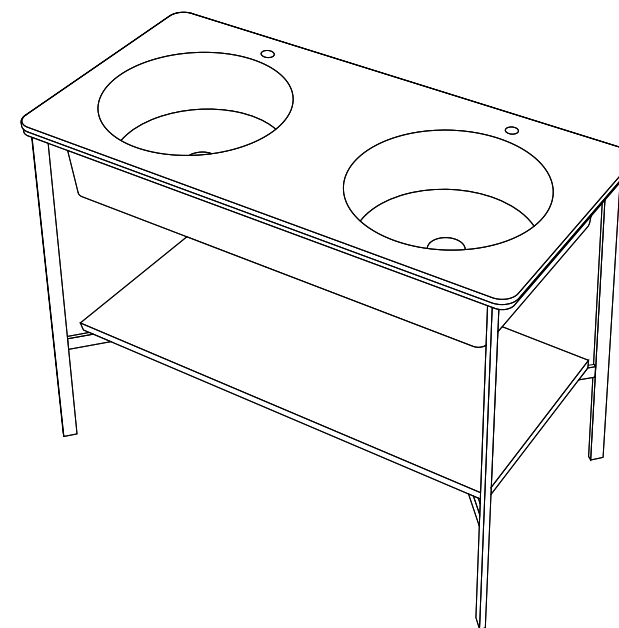

CATINO DOPPIO

con piano / с полочкой столешни

con cassetto / с ящиком

cm 110 x 58,5 x 83 h

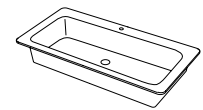

LAVABO / РАКОВИНА

CERAMICA / КЕРАМИЧЕСКАЯ



OLTREMARE



SMERALDO



ALGA



CORALLO



NINFEA



ANEMONE



PIANO / СТОЛЕШНИЦА

ESSENZA / ДЕРЕВО

ROVERE
NATURALEROVERE
SBIANCATOROVERE
GRIGIOROVERE
NERO

EUCALIPTO

AZUL
NOCHE

PIETRA / КАМЕНЬ

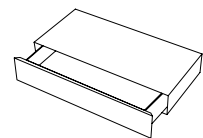

CASSETTO / ЯЩИК

ESSENZA / ДЕРЕВО

ROVERE
NATURALEROVERE
SBIANCATOROVERE
GRIGIOROVERE
NERO

EUCALIPTO

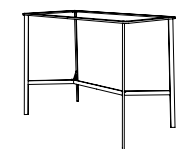

STRUTTURA / КАРКАС

METALLO / МЕТАЛЛ



OLTREMARE



SMERALDO



ALGA



CORALLO



NINFEA



ANEMONE

NERO MATT
/ MATT BLACK

CEMENTO

CATINO RETTANGOLARE

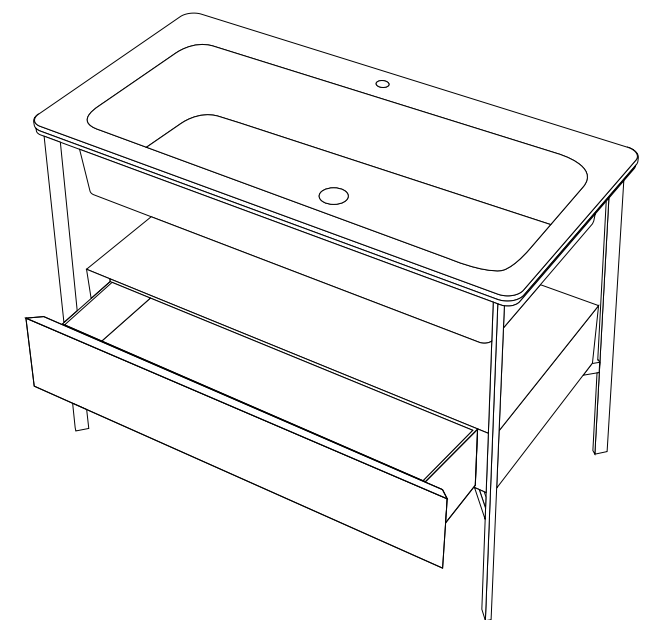
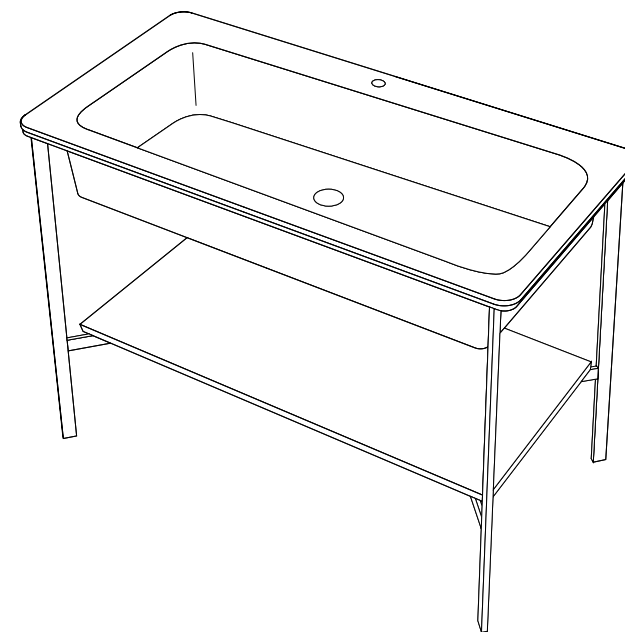

CATINO RETTANGOLARE

con piano / с полочкой столешни

con cassetto / с ящиком

cm 110 x 58,5 x 83 h

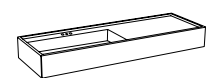

LAVABO / РАКОВИНА

CERAMICA / КЕРАМИЧЕСКАЯ



+



PIANO / СТОЛЕШНИЦА

ESSENZA / ДЕРЕВО

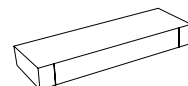

CASSETTO / ЯЩИК

+

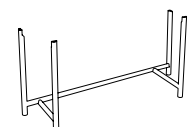

STRUTTURA / КАРКАС

ESSENZA / ДЕРЕВО



METALLO / METAL



+

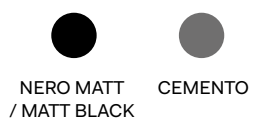

CESTE IN CUOIO / КОРЗИНА ИЗ КОЖИ

CUOIO / КОЖИ



PLINIO

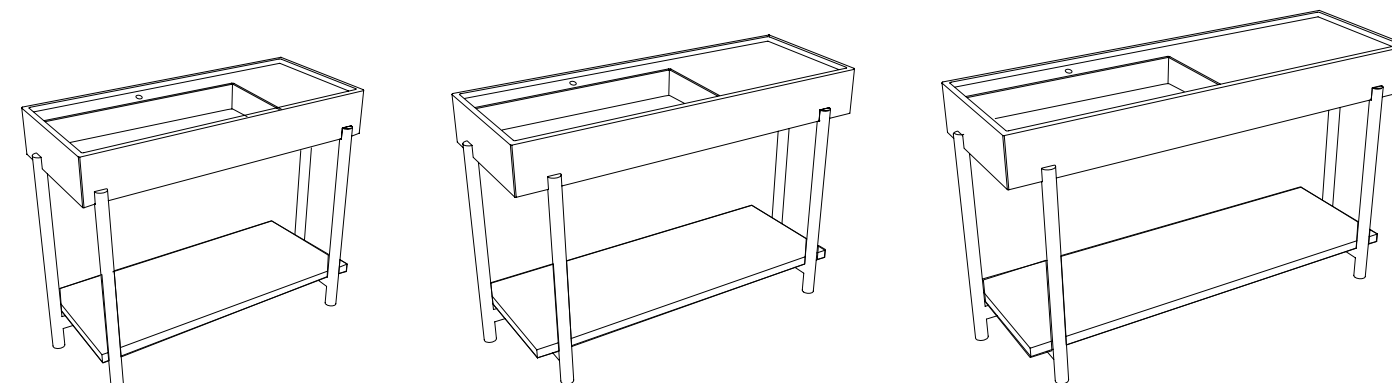
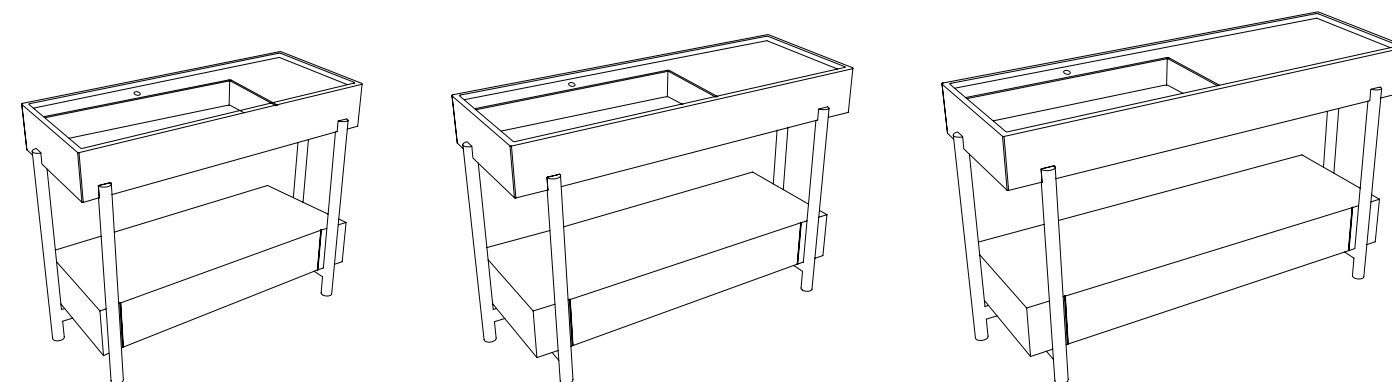

PLINIO

con piano / с полочкой столешни

con cassetto / с ящиком

cm 85 x 46 x 82,5 h

cm 115 x 46 x 82,5 h

cm 140 x 46 x 82,5 h



BACINELLA / БАСЕЙН ТИНО

CERAMICA / КЕРАМИЧЕСКАЯ



TOP OVALE / ОВАЛЬНАЯ ПЛОСКОСТЬ

CERAMICA / КЕРАМИЧЕСКАЯ

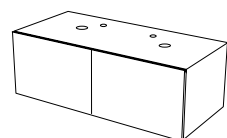

MOBILE VERSIONE LISCIA / ТУМБА С ПЕРЕДНЕЙ ДВЕРЦЕЙ ГЛАДКИЙ

ESSENZA / ДЕРЕВО

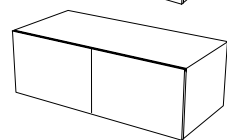

MOBILE VERSIONE CON LISTELLI DI MASSELLO TRIANGOLARI / ТУМБА С ПЕРЕДНЕЙ ДВЕРЦЕЙ ИЗ МАССИВА БРУСА ТРЕУГОЛЬНОЙ ФОРМЫ ИЗ НАТУРАЛЬНОГО ШПОНА ДЕРЕВА.

ESSENZA / ДЕРЕВО

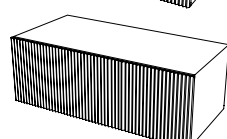
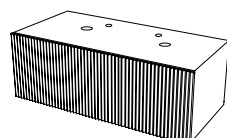

DELFO

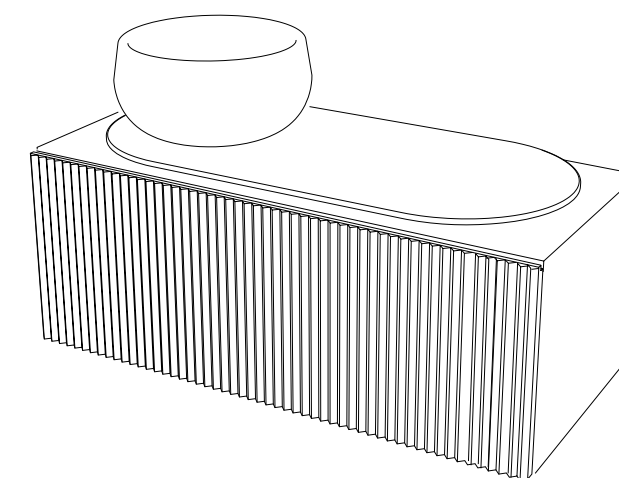
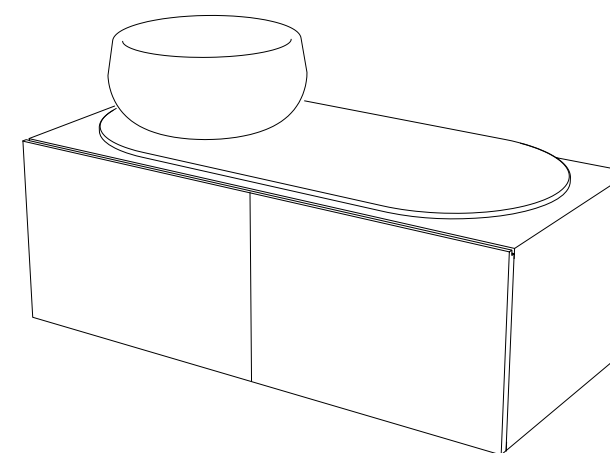

DELFO

cm 113 x 52 x 40 h

BACINELLE DISPONIBILI NELLE FINITURE "LE ACQUE DI CIELO"
РАКОВИНЫ В ОТДЕЛКЕ "LE ACQUE DI CIELO"

LE BACINELLE



TINA
Bacinella
бассейн
cm Ø45 x 26 h



TINO
Bacinella
бассейн
cm Ø43 x 19 h



ECO
Bacinella
бассейн
cm 62 x 45 x 18 h



ECO SMALL
Bacinella
бассейн
cm 58 x 42 x 16,5 h



ERA
Bacinella
бассейн
cm Ø45 x 24 h



ERA SMALL
Bacinella
бассейн
cm Ø40 x 15 h



HANDY
Bacinella monoforo
\ бассейн одно
отверстие под
смеситель
cm Ø45 x 16,8 h

SHUI COMFORT

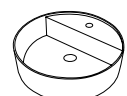

TONDO MONOFORO
круглый одно
отверстие под
смеситель
cm Ø45 x 13 h

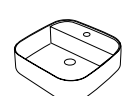

QUADRATO MONOFORO
квадрат одно
отверстие под
смеситель
cm 44 x 43 x 13,5 h

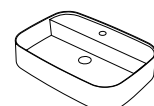

RETTANGOLARE MONOFORO
прямоугольный
одно отверстие под
смеситель
cm 60 x 43 x 13 h



TONDO
круглый
cm Ø40 x 12,5 h



QUADRATO
квадрат
cm 40 x 40 x 12,5 h

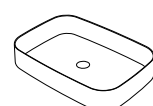

RETTANGOLARE
прямоугольный
cm 60 x 40 x 12,5 h

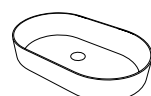

OVALE
Овал
cm 60 x 38 x 12,5 h



MINIMO QUADRATO
Minimo квадрат
cm 25 x 25 x 11,5 h



MINIMO TONDO
Minimo круглый
cm Ø25 x 11,5 h

SHUI



SHUI 40
Bacinella
бассейн
cm Ø40 x 18,5 h



SHUI 45
Bacinella
бассейн
cm Ø45 x 12,5 h

CERAMICA / КЕРАМИЧЕСКАЯ



OLTREMARE SMERALDO ALGA CORALLO NINFEA ANEMONE

SPECCHI DISPONIBILI NELLE FINITURE "LE ACQUE DI CIELO"
ЗЕРКАЛА В ОТДЕЛКЕ "LE ACQUE DI CIELO"



ROUND BOX 75
Specchio contenitore 75
Зеркальный шкафчик 75
cm Ø75 x 12



ROUND BOX 90
Specchio contenitore 90
Зеркальный шкафчик 90
cm Ø90 x 12



OVAL BOX
Specchio contenitore
Зеркальный шкафчик
cm 50 x 12 x 90 h

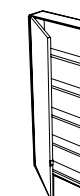

SIMPLE TALL BOX
Specchio contenitore
Зеркальный шкафчик
cm 45 x 12 x 110 h

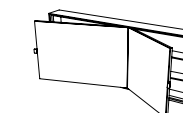

SIMPLE BOX
Specchio contenitore
Зеркальный шкафчик
cm 90 x 12 x 45 h

LACCATURA / ЛАКИРОВКА

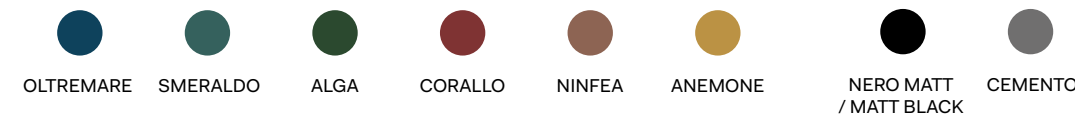

OLTREMARE SMERALDO ALGA CORALLO NINFEA ANEMONE NERO MATT / MATT BLACK CEMENTO

SANITARI DISPONIBILI NELLE FINITURE “LE ACQUE DI CIELO”
САНТЕХНИКА ДОСТУПНАЯ В ОТДЕЛКЕ “LE ACQUE DI CIELO”

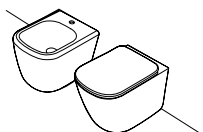
ERA

ERA
Wc e bidet a terra
унитаз и Биде напольное

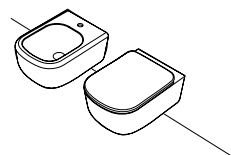

ERA
Wc e bidet sospesi
унитаз и Биде подвесное

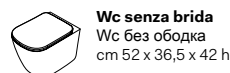

Wc senza brida
Wc без ободка
cm 52 x 36,5 x 42 h



Wc senza brida
Wc без ободка
cm 53 x 36,5 x 30 h



Bidet
cm 52 x 36,5 x 42 h

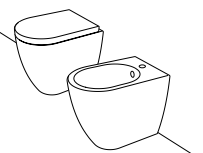

Bidet
cm 53 x 36,5 x 30 h

SMILE

SMILE 48
Wc e bidet a terra
унитаз и Биде напольное

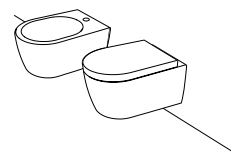

SMILE 48
Wc e bidet sospesi
унитаз и Биде подвесное

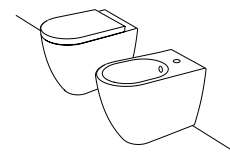

SMILE 53
Wc e bidet a terra
унитаз и Биде напольное

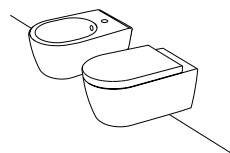

SMILE 53
Wc e bidet sospesi
унитаз и Биде подвесное

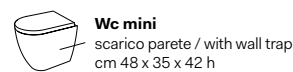

Wc mini
scarico parete / with wall trap
cm 48 x 35 x 42 h

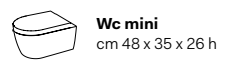

Wc mini
cm 48 x 35 x 26 h

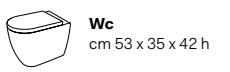

Wc
cm 53 x 35 x 42 h



Wc
cm 53 x 35 x 27 h

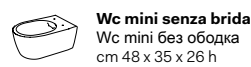

Wc mini senza brida
Wc mini без ободка
cm 48 x 35 x 26 h

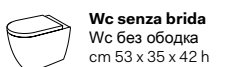

Wc senza brida
Wc без ободка
cm 53 x 35 x 42 h

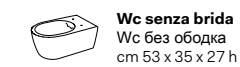

Wc senza brida
Wc без ободка
cm 53 x 35 x 27 h

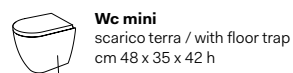

Wc mini
scarico terra / with floor trap
cm 48 x 35 x 42 h



Bidet mini
cm 48 x 35 x 26 h

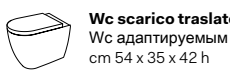

Wc scarico traslato
Wc адаптируемым выпуском
cm 54 x 35 x 42 h



Bidet
cm 53 x 35 x 27 h



Bidet mini
cm 48 x 35 x 42 h



Bidet
cm 53 x 35 x 42 h

CERAMICA / КЕРАМИЧЕСКАЯ

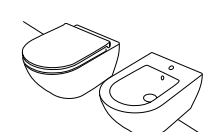

OLTREMARE SMERALDO ALGA CORALLO NINFEA ANEMONE

ENJOY

ENJOY 48
Wc e bidet sospesi
унитаз и Биде подвесное

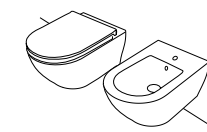

ENJOY 53
Wc e bidet sospesi
унитаз и Биде подвесное

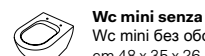

Wc mini senza brida
Wc mini без ободка
cm 48 x 35 x 26,5 h



Wc
cm 53 x 35 x 26,5 h



Bidet mini
cm 48 x 35 x 26,5 h



Wc senza brida
Wc без ободка
cm 53 x 35 x 26,5 h



Bidet
cm 53 x 35 x 26,5 h

CERAMICA / КЕРАМИЧЕСКАЯ



OLTREMARE SMERALDO ALGA CORALLO NINFEA ANEMONE

ACCESSORI



MENSOLA TONDA / ПОЛОЧКА КРУГЛАЯ
cm Ø 12 x 3 h



PIANO / ПОЛОЧКА



STRUTTURA / СТРУКТУРА

VETRO RETROVERNICIATO / ОКРАШЕННОГО СТЕКЛА



PIETRA / КАМЕНЬ



METALLO / МЕТАЛЛ

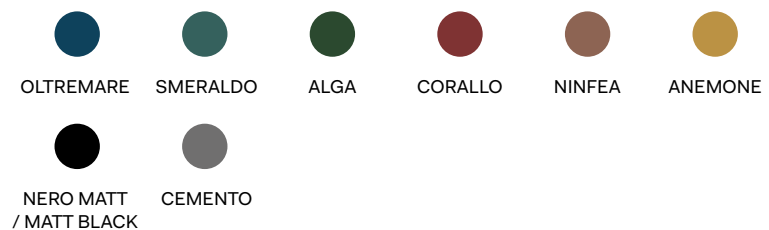

АКЦЕССУАРЫ



MENSOLA OVALE / ПОЛОЧКА ОВАЛЬНАЯ
cm 25 x 12 x 3 h



PIANO / ПОЛОЧКА



STRUTTURA / СТРУКТУРА

VETRO RETROVERNICIATO / ОКРАШЕННОГО СТЕКЛА



PIETRA / КАМЕНЬ

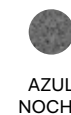

METALLO / МЕТАЛЛ

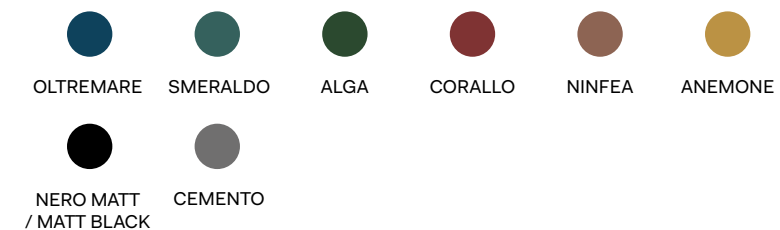

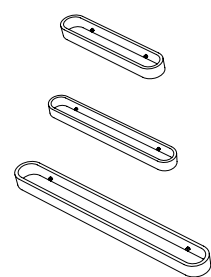

PORTASCIUGAMANI OVALE
/ ПОЛОТЕНЦЕДЕРЖАТЕЛЬ,
ОВАЛЬНЫЙ ВЕРСИЯ

cm 30 x 6 x 3 h
cm 45 x 6 x 3 h
cm 60 x 6 x 3 h

METALLO / МЕТАЛЛ



OLTREMARE



SMERALDO



ALGA



CORALLO



NINFEA



ANEMONE



NERO MATT
/ MATT BLACK



CEMENTO



GANCIO / КРЮЧОК

gancio 1 / Крючок 1
gancio 2 / Крючок 2
cm Ø3 x 4

METALLO / МЕТАЛЛ



OLTREMARE



SMERALDO



ALGA



CORALLO



NINFEA



ANEMONE



NERO MATT
/ MATT BLACK



CEMENTO

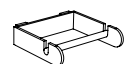

PORTAROTOLO / ДЕРЖАТЕЛЬ
ТУАЛЕТНОЙ БУМАГИ ИЗ
МЕТАЛЛА

cm 12 x 10 x 3 h

METALLO / МЕТАЛЛ



OLTREMARE



SMERALDO



ALGA



CORALLO



NINFEA



ANEMONE



NERO MATT
/ MATT BLACK



CEMENTO



DISPENSER / ДИСПЕНСЕР

cm Ø6 x 18 h

METALLO / МЕТАЛЛ



OLTREMARE



SMERALDO



ALGA



CORALLO



NINFEA



ANEMONE



NERO MATT
/ MATT BLACK



CEMENTO



BICCHIERE / СТАКАНЧИК ИЗ
МЕТАЛЛА

cm Ø6 x 11 h

METALLO / МЕТАЛЛ



OLTREMARE



SMERALDO



ALGA



CORALLO



NINFEA



ANEMONE



NERO MATT
/ MATT BLACK



CEMENTO



PORTASCIUGAMANI
AD ANELLO
/ ПОЛОТЕНЦЕДЕРЖАТЕЛЬ-
КОЛЬЦО

cm Ø32

METALLO / МЕТАЛЛ



OLTREMARE



SMERALDO



ALGA



CORALLO



NINFEA



ANEMONE



NERO MATT
/ MATT BLACK



CEMENTO

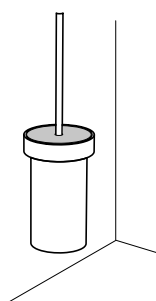

PORTASCOPINO SOSPESO
/ ЕРШИК ДЛЯ УНИТАЗА НАСТЕННЫЙ
cm Ø12 x 42 h

=

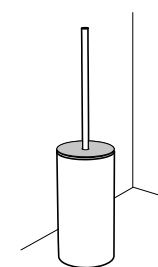

PORTASCOPINO DA TERRA
/ ЕРШИК ДЛЯ УНИТАЗА НАПОЛЬНЫЙ
cm Ø12 x 42 h

=

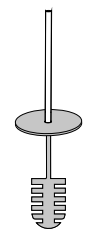

PIANO E SCOPINO /
ПОЛОЧКА ЕРШИК

+

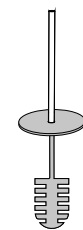

PIANO E SCOPINO /
ПОЛОЧКА ЕРШИК

+

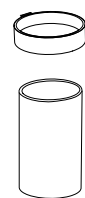

STRUTTURA / СТРУКТУРА

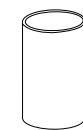

STRUTTURA / СТРУКТУРА









VETRO RETROVERNICIATO / ОКРАШЕННОГО СТЕКЛА

- 
OLTREMARE
- 
SMERALDO
- 
ALGA
- 
CORALLO
- 
NINFEA
- 
ANEMONE
- 
CEMENTO

PIETRA / КАМЕНЬ

- 
AZUL
NOCHE

METALLO / МЕТАЛЛ

- 
OLTREMARE
 - 
SMERALDO
 - 
ALGA
 - 
CORALLO
 - 
NINFEA
 - 
ANEMONE
- 
NERO MATT
/ MATT BLACK
 - 
CEMENTO

VETRO RETROVERNICIATO / ОКРАШЕННОГО СТЕКЛА

- 
OLTREMARE
- 
SMERALDO
- 
ALGA
- 
CORALLO
- 
NINFEA
- 
ANEMONE
- 
CEMENTO

PIETRA / КАМЕНЬ

- 
AZUL
NOCHE

METALLO / МЕТАЛЛ

- 
OLTREMARE
 - 
SMERALDO
 - 
ALGA
 - 
CORALLO
 - 
NINFEA
 - 
ANEMONE
- 
NERO MATT
/ MATT BLACK
 - 
CEMENTO

LISTINO PREZZI
ПРАЙС-ЛИСТ

ЗАКАЗ ИЗДЕЛИЙ В НОВЫХ ОТДЕЛКАХ ВОЗМОЖЕН ТОЛЬКО ПРИ НАЛИЧИИ ХОТЯ БЫ ОДНОЙ КОМПОЗИЦИИ В ДАННЫХ ЦВЕТАХ НА ЭКСПОЗИЦИИ

Modulo Ordine Catino Tondo

Catino Tondo Order Form

cielo

CLIENTE/client: ORD. REF.:

QUANTITA'/quantity: EMAIL:

INDICARE CON UN SEGNO LE FINITURE SCELTE PER I DIVERSI COMPONENTI

INDICATE WITH A TICK, THE CHOOSEN FINISHES FOR ALL THE COMPONENTS

art. **CASTT**

FINITURE STRUTTURA

FRAMEWORK FINISHES

verniciature_coatings

Le Acque di Cielo

- OL - Oltremare
- SM - Smeraldo
- AL - Alga
- CO - Corallo
- NI - Ninfea
- AM - Anemone

- NM - Nero Matt
- CM - Cemento

art. **CALAT**

FINITURE LAVABO

WASHBASIN SHELF FINISHES

Le Acque di Cielo

- OL - Oltremare
- SM - Smeraldo
- AL - Alga
- CO - Corallo
- NI - Ninfea
- AM - Anemone

art. **CAPIT**

FINITURE PIANO IN CERAMICA

BOTTOM CERAMIC SHELF FINISHES

Le Acque di Cielo

- OL - Oltremare
- SM - Smeraldo
- AL - Alga
- CO - Corallo
- NI - Ninfea
- AM - Anemone

art. **CAPITM**

FINITURE PIANO IN PIETRA

STONE BOTTOM SHELF FINISHES

- AZ - Azul Noche

DATA
DATE

FIRMA DEL CLIENTE
SIGNATURE

ATTENZIONE:

La rappresentazione delle finiture è puramente indicativa. Verificare le finiture con le relative cartelle.

Ogni oggetto possiede la peculiarità di essere elaborato secondo principi puramente tradizionali, in modo da garantirne l'assoluta originalità ed unicità. Le eventuali piccole variazioni di colore, tono o venature fra gli articoli sono da considerarsi pregi e non difetti, in quanto garanzia della fattura manuale del prodotto, che fa di ogni oggetto Cielo un pezzo unico ed esclusivo, lontano dall'omologazione industriale. In fase d'ordine si intendono, pertanto, accettate tali tolleranze che non possono dare adito a contestazioni di alcun genere.

Verificare sempre le disponibilità e i tempi di consegna con il commerciale.

ATTENTION:

The representation of the finishes is merely indicative. Please choose the finishes using the folders.

Every item possesses that particular feature of being processed according to purely traditional principles that guarantee its absolute originality and uniqueness. The small variations in colour, hues or streaks on the items are to be considered as qualities and not defects, since they warranty the handcrafted processing which makes each Cielo item a unique and exclusive piece that cannot be compared to industrial standardization. When making the order, the client implicitly accepts those various features that may give rise to claims of any sort.

Always check the availability and delivery time with the commercial department.

Modulo Ordine Catino Ovale monoforo con piano

Catino Ovale with one hole, with shelf Order Form

cielo

CLIENTE/client: ORD. REF.:

QUANTITA'/quantity: EMAIL:

INDICARE CON UN SEGNO LE FINITURE SCELTE PER I DIVERSI COMPONENTI

INDICATE WITH A TICK, THE CHOSEN FINISHES FOR ALL THE COMPONENTS

art. **CASTO**

FINITURE STRUTTURA

FRAMEWORK FINISHES

verniciature_coatings

Le Acque di Cielo

- OL - Oltremare
- SM - Smeraldo
- AL - Alga
- CO - Corallo
- NI - Ninfea
- AM - Anemone

NM - Nero Matt

CM - Cemento

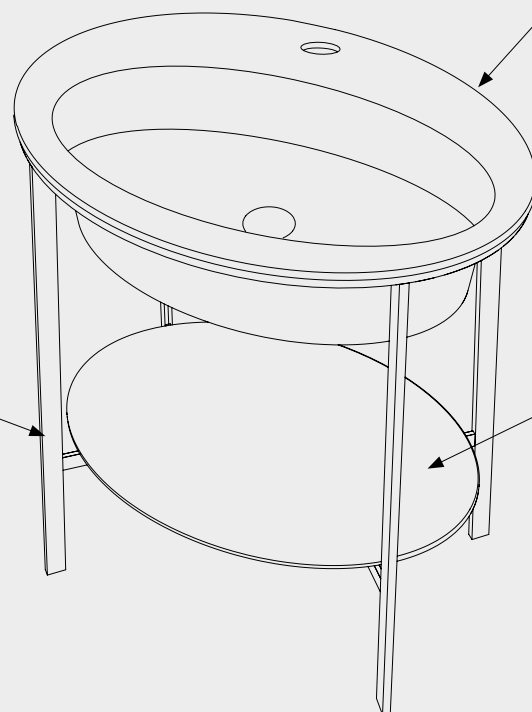

art. **CALAOF**

FINITURE LAVABO

WASHBASIN SHELF FINISHES

Le Acque di Cielo

- OL - Oltremare
- SM - Smeraldo
- AL - Alga
- CO - Corallo
- NI - Ninfea
- AM - Anemone

art. **CAPIO**

FINITURE PIANO IN CERAMICA

BOTTOM CERAMIC SHELF FINISHES

Le Acque di Cielo

- OL - Oltremare
- SM - Smeraldo
- AL - Alga
- CO - Corallo
- NI - Ninfea
- AM - Anemone

art. **CAPIOM**

FINITURE PIANO IN PIETRA

STONE BOTTOM SHELF FINISHES

- AZ - Azul Noche

DATA
DATE

FIRMA DEL CLIENTE
SIGNATURE

ATTENZIONE:
La rappresentazione delle finiture è puramente indicativa. Verificare le finiture con le relative cartelle.

Ogni oggetto possiede la peculiarità di essere elaborato secondo principi puramente tradizionali, in modo da garantirne l'assoluta originalità ed unicità. Le eventuali piccole variazioni di colore, tono o venature fra gli articoli sono da considerarsi pregi e non difetti, in quanto garanzia della fattura manuale del prodotto, che fa di ogni oggetto Cielo un pezzo unico ed esclusivo, lontano dall'omologazione industriale. In fase d'ordine si intendono, pertanto, accettate tali tolleranze che non possono dare adito a contestazioni di alcun genere.

Verificare sempre le disponibilità e i tempi di consegna con il commerciale.

ATTENTION:
The representation of the finishes is merely indicative. Please choose the finishes using the folders.

Every item possesses that particular feature of being processed according to purely traditional principles that guarantee its absolute originality and uniqueness. The small variations in colour, hues or streaks on the items are to be considered as qualities and not defects, since they warranty the handcrafted processing which makes each Cielo item a unique and exclusive piece that cannot be compared to industrial standardization. When making the order, the client implicitly accepts those various features that may give rise to claims of any sort.

Always check the availability and delivery time with the commercial department.

Modulo Ordine Catino Ovale monoforo con cassetto

Catino Ovale with one hole, with drawer Order Form

cielo

CLIENTE/client: ORD. REF.:

QUANTITA'/quantity: EMAIL:

INDICARE CON UN SEGNO LE FINITURE SCELTE PER I DIVERSI COMPONENTI

INDICATE WITH A TICK, THE CHOSEN FINISHES FOR ALL THE COMPONENTS

art. **CASTO**

FINITURE STRUTTURA

FRAMEWORK FINISHES

verniciature_coatings

Le Acque di Cielo

- OL - Oltremare
- SM - Smeraldo
- AL - Alga
- CO - Corallo
- NI - Ninfea
- AM - Anemone

NM - Nero Matt

CM - Cemento

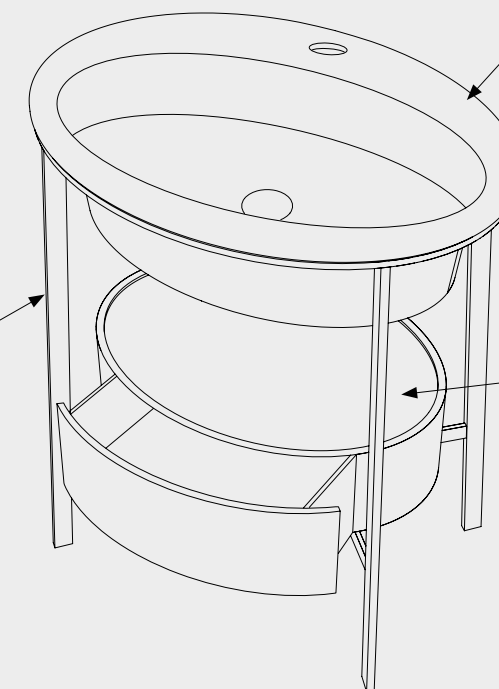

art. **CALAOF**

FINITURE LAVABO

WASHBASIN SHELF FINISHES

Le Acque di Cielo

- OL - Oltremare
- SM - Smeraldo
- AL - Alga
- CO - Corallo
- NI - Ninfea
- AM - Anemone

art. **CACOE**

FINITURE CASSETTO IN LEGNO

WOODEN DRAWER FINISHES

essenze legno/wood essences

- RG - Rovere Grigio
- RS - Rovere Sbiancato
- RN - Rovere Naturale
- RO - Rovere Nero
- EU - Eucalipto

DATA
DATE

FIRMA DEL CLIENTE
SIGNATURE

ATTENZIONE:
La rappresentazione delle finiture è puramente indicativa. Verificare le finiture con le relative cartelle.

Ogni oggetto possiede la peculiarità di essere elaborato secondo principi puramente tradizionali, in modo da garantirne l'assoluta originalità ed unicità. Le eventuali piccole variazioni di colore, tono o venature fra gli articoli sono da considerarsi pregi e non difetti, in quanto garanzia della fattura manuale del prodotto, che fa di ogni oggetto Cielo un pezzo unico ed esclusivo, lontano dall'omologazione industriale. In fase d'ordine si intendono, pertanto, accettate tali tolleranze che non possono dare adito a contestazioni di alcun genere.

Verificare sempre le disponibilità e i tempi di consegna con il commerciale.

ATTENTION:
The representation of the finishes is merely indicative. Please choose the finishes using the folders.

Every item possesses that particular feature of being processed according to purely traditional principles that guarantee its absolute originality and uniqueness. The small variations in colour, hues or streaks on the items are to be considered as qualities and not defects, since they warranty the handcrafted processing which makes each Cielo item a unique and exclusive piece that cannot be compared to industrial standardization. When making the order, the client implicitly accepts those various features that may give rise to claims of any sort.

Always check the availability and delivery time with the commercial department.

Modulo Ordine Catino Ovale con piano

Catino Ovale with shelf Order Form

cielo

CLIENTE/client: ORD. REF.: QUANTITA'/quantity: EMAIL:

INDICARE CON UN SEGNO LE FINITURE SCELTE PER I DIVERSI COMPONENTI

INDICATE WITH A TICK, THE CHOOSEN FINISHES FOR ALL THE COMPONENTS

art. CASTO

FINITURE STRUTTURA

FRAMEWORK FINISHES

verniciature_coatings

Le Acque di Cielo

- OL - Oltremare
- SM - Smeraldo
- AL - Alga
- CO - Corallo
- NI - Ninfea
- AM - Anemone

- NM - Nero Matt
- CM - Cemento

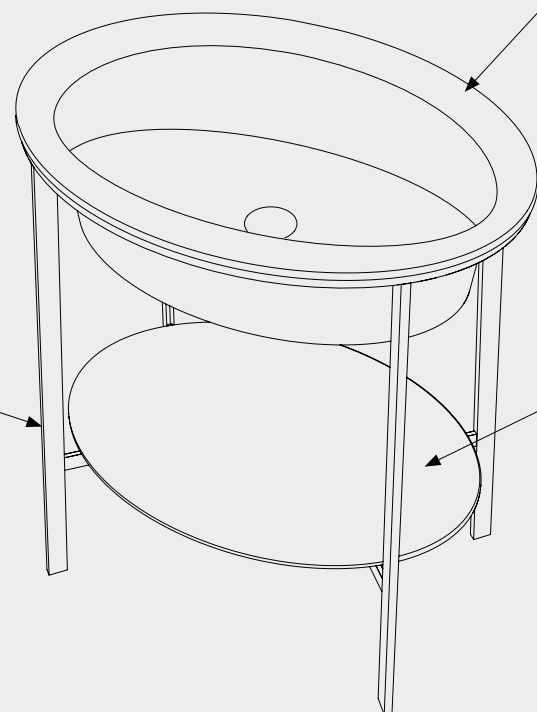

art. CALAO

FINITURE LAVABO

WASHBASIN SHELF FINISHES

Le Acque di Cielo

- OL - Oltremare
- SM - Smeraldo
- AL - Alga
- CO - Corallo
- NI - Ninfea
- AM - Anemone

art. CAPIO

FINITURE PIANO IN CERAMICA

BOTTOM CERAMIC SHELF FINISHES

Le Acque di Cielo

- OL - Oltremare
- SM - Smeraldo
- AL - Alga
- CO - Corallo
- NI - Ninfea
- AM - Anemone

art. CAPIOM

FINITURE PIANO IN PIETRA

STONE BOTTOM SHELF FINISHES

- AZ - Azul Noche

DATA
DATEFIRMA DEL CLIENTE
SIGNATUREATTENZIONE:
La rappresentazione delle finiture è puramente indicativa. Verificare le finiture con le relative cartelle.

Ogni oggetto possiede la peculiarità di essere elaborato secondo principi puramente tradizionali, in modo da garantirne l'assoluta originalità ed unicità. Le eventuali piccole variazioni di colore, tono o venature fra gli articoli sono da considerarsi pregi e non difetti, in quanto garanzia della fattura manuale del prodotto, che fa di ogni oggetto Cielo un pezzo unico ed esclusivo, lontano dall'omologazione industriale. In fase d'ordine si intendono, pertanto, accettate tali tolleranze che non possono dare adito a contestazioni di alcun genere.

Verificare sempre le disponibilità e i tempi di consegna con il commerciale.

ATTENTION:
The representation of the finishes is merely indicative. Please choose the finishes using the folders.

Every item possesses that particular feature of being processed according to purely traditional principles that guarantee its absolute originality and uniqueness. The small variations in colour, hues or streaks on the items are to be considered as qualities and not defects, since they warranty the handcrafted processing which makes each Cielo item a unique and exclusive piece that cannot be compared to industrial standardization. When making the order, the client implicitly accepts those various features that may give rise to claims of any sort.

Always check the availability and delivery time with the commercial department.

Modulo Ordine Catino Ovale con Cassetto

Catino Ovale with drawer Order Form

cielo

CLIENTE/client: ORD. REF.: QUANTITA'/quantity: EMAIL:

INDICARE CON UN SEGNO LE FINITURE SCELTE PER I DIVERSI COMPONENTI

INDICATE WITH A TICK, THE CHOOSEN FINISHES FOR ALL THE COMPONENTS

art. CASTO

FINITURE STRUTTURA

FRAMEWORK FINISHES

verniciature_coatings

Le Acque di Cielo

- OL - Oltremare
- SM - Smeraldo
- AL - Alga
- CO - Corallo
- NI - Ninfea
- AM - Anemone

- NM - Nero Matt
- CM - Cemento

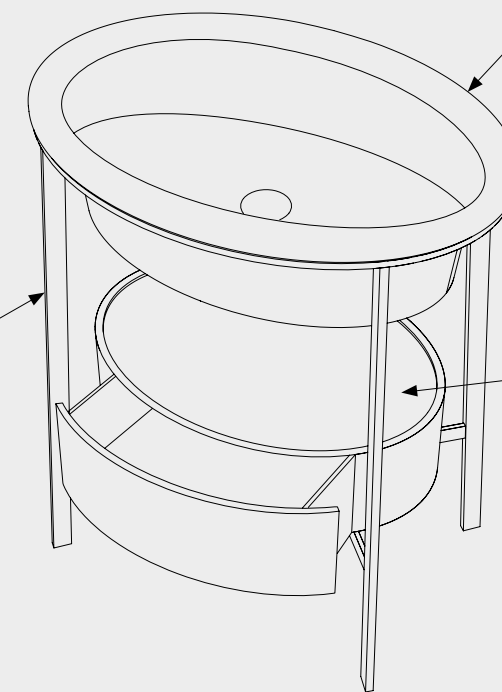

art. CALAO

FINITURE LAVABO

WASHBASIN SHELF FINISHES

Le Acque di Cielo

- OL - Oltremare
- SM - Smeraldo
- AL - Alga
- CO - Corallo
- NI - Ninfea
- AM - Anemone

art. CACOE

FINITURE CASSETTO IN LEGNO

WOODEN DRAWER FINISHES

essenze legno/wood essences

- RG - Rovere Grigio
- RS - Rovere Sbiancato
- RN - Rovere Naturale
- RO - Rovere Nero
- EU - Eucalipto

DATA
DATEFIRMA DEL CLIENTE
SIGNATUREATTENZIONE:
La rappresentazione delle finiture è puramente indicativa. Verificare le finiture con le relative cartelle.

Ogni oggetto possiede la peculiarità di essere elaborato secondo principi puramente tradizionali, in modo da garantirne l'assoluta originalità ed unicità. Le eventuali piccole variazioni di colore, tono o venature fra gli articoli sono da considerarsi pregi e non difetti, in quanto garanzia della fattura manuale del prodotto, che fa di ogni oggetto Cielo un pezzo unico ed esclusivo, lontano dall'omologazione industriale. In fase d'ordine si intendono, pertanto, accettate tali tolleranze che non possono dare adito a contestazioni di alcun genere.

Verificare sempre le disponibilità e i tempi di consegna con il commerciale.

ATTENTION:
The representation of the finishes is merely indicative. Please choose the finishes using the folders.

Every item possesses that particular feature of being processed according to purely traditional principles that guarantee its absolute originality and uniqueness. The small variations in colour, hues or streaks on the items are to be considered as qualities and not defects, since they warranty the handcrafted processing which makes each Cielo item a unique and exclusive piece that cannot be compared to industrial standardization. When making the order, the client implicitly accepts those various features that may give rise to claims of any sort.

Always check the availability and delivery time with the commercial department.

Modulo Ordine Catino Doppio con piano

Catino Doppio with shelf Order Form

cielo

CLIENTE/client: ORD. REF.: QUANTITA'/quantity: EMAIL:

INDICARE CON UN SEGNO LE FINITURE SCELTE PER I DIVERSI COMPONENTI

INDICATE WITH A TICK, THE CHOSEN FINISHES FOR ALL THE COMPONENTS

art. **CASTD**

FINITURE STRUTTURA

FRAMEWORK FINISHES

verniciature_coatings

Le Acque di Cielo

- OL - Oltremare
- SM - Smeraldo
- AL - Alga
- CO - Corallo
- NI - Ninfea
- AM - Anemone

- NM - Nero Matt
- CM - Cemento

art. **CALAD**

FINITURE LAVABO

WASHBASIN SHELF FINISHES

Le Acque di Cielo

- OL - Oltremare
- SM - Smeraldo
- AL - Alga
- CO - Corallo
- NI - Ninfea
- AM - Anemone

art. **CAPIDE**

FINITURE PIANO IN LEGNO

BOTTOM WOODEN SHELF FINISHES

essenze legno/wood essences

- RS - Rovere Sbiancato
- RN - Rovere Naturale
- RG - Rovere Grigio
- RO - Rovere Nero
- EU - Eucalipto

art. **CAPIDM**

FINITURE PIANO IN PIETRA

STONE BOTTOM SHELF FINISHES

- AZ - Azul Noche

N.B. Il lavabo ha 2 fori predisposto 6 fori, su richiesta può essere prodotto senza foro*N.B. The washbasin has 2 hole prepared 6 holes ; may be made without holes upon request*DATA
DATEFIRMA DEL CLIENTE
SIGNATUREATTENZIONE:
La rappresentazione delle finiture è puramente indicativa. Verificare le finiture con le relative cartelle.

Ogni oggetto possiede la peculiarità di essere elaborato secondo principi puramente tradizionali, in modo da garantirne l'assoluta originalità ed unicità. Le eventuali piccole variazioni di colore, tono o venature fra gli articoli sono da considerarsi pregi e non difetti, in quanto garanzia della fattura manuale del prodotto, che fa di ogni oggetto Cielo un pezzo unico ed esclusivo, lontano dall'omologazione industriale. In fase d'ordine si intendono, pertanto, accettate tali tolleranze che non possono dare adito a contestazioni di alcun genere.

Verificare sempre le disponibilità e i tempi di consegna con il commerciale.

ATTENTION:
The representation of the finishes is merely indicative. Please choose the finishes using the folders.

Every item possesses that particular feature of being processed according to purely traditional principles that guarantee its absolute originality and uniqueness. The small variations in colour, hues or streaks on the items are to be considered as qualities and not defects, since they warranty the handcrafted processing which makes each Cielo item a unique and exclusive piece that cannot be compared to industrial standardization. When making the order, the client implicitly accepts those various features that may give rise to claims of any sort.

Always check the availability and delivery time with the commercial department.

Modulo Ordine Catino Doppio con cassetto

Catino Doppio with drawer Order Form

cielo

CLIENTE/client: ORD. REF.: QUANTITA'/quantity: EMAIL:

INDICARE CON UN SEGNO LE FINITURE SCELTE PER I DIVERSI COMPONENTI

INDICATE WITH A TICK, THE CHOSEN FINISHES FOR ALL THE COMPONENTS

art. **CASTD**

FINITURE STRUTTURA

FRAMEWORK FINISHES

verniciature_coatings

Le Acque di Cielo

- OL - Oltremare
- SM - Smeraldo
- AL - Alga
- CO - Corallo
- NI - Ninfea
- AM - Anemone

- NM - Nero Matt
- CM - Cemento

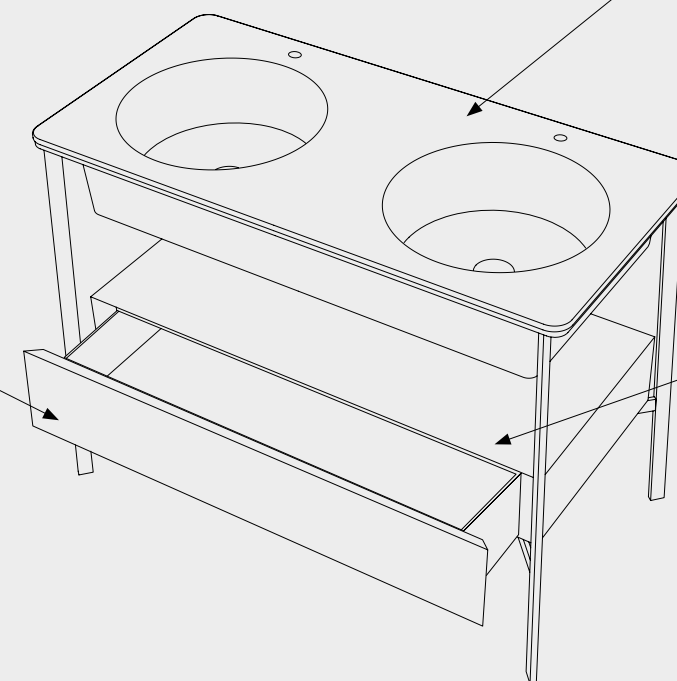
art. **CALAD**

FINITURE LAVABO

WASHBASIN SHELF FINISHES

Le Acque di Cielo

- OL - Oltremare
- SM - Smeraldo
- AL - Alga
- CO - Corallo
- NI - Ninfea
- AM - Anemone

art. **CACDE**

FINITURE CASSETTO IN LEGNO

WOODEN DRAWER FINISHES

essenze legno/wood essences

- RG - Rovere Grigio
- RS - Rovere Sbiancato
- RN - Rovere Naturale
- RO - Rovere Nero
- EU - Eucalipto

N.B. Il lavabo ha 2 fori predisposto 6 fori, su richiesta può essere prodotto senza foro*N.B. The washbasin has 2 hole prepared 6 holes ; may be made without holes upon request*DATA
DATEFIRMA DEL CLIENTE
SIGNATUREATTENZIONE:
La rappresentazione delle finiture è puramente indicativa. Verificare le finiture con le relative cartelle.

Ogni oggetto possiede la peculiarità di essere elaborato secondo principi puramente tradizionali, in modo da garantirne l'assoluta originalità ed unicità. Le eventuali piccole variazioni di colore, tono o venature fra gli articoli sono da considerarsi pregi e non difetti, in quanto garanzia della fattura manuale del prodotto, che fa di ogni oggetto Cielo un pezzo unico ed esclusivo, lontano dall'omologazione industriale. In fase d'ordine si intendono, pertanto, accettate tali tolleranze che non possono dare adito a contestazioni di alcun genere.

Verificare sempre le disponibilità e i tempi di consegna con il commerciale.

ATTENTION:
The representation of the finishes is merely indicative. Please choose the finishes using the folders.

Every item possesses that particular feature of being processed according to purely traditional principles that guarantee its absolute originality and uniqueness. The small variations in colour, hues or streaks on the items are to be considered as qualities and not defects, since they warranty the handcrafted processing which makes each Cielo item a unique and exclusive piece that cannot be compared to industrial standardization. When making the order, the client implicitly accepts those various features that may give rise to claims of any sort.

Always check the availability and delivery time with the commercial department.

Modulo Ordine Catino Rettangolare con piano

Catino Rettangolare with shelf Order Form

cielo

CLIENTE/client: ORD. REF.:

QUANTITA'/quantity: EMAIL:

INDICARE CON UN SEGNO LE FINITURE SCELTE PER I DIVERSI COMPONENTI

INDICATE WITH A TICK, THE CHOOSEN FINISHES FOR ALL THE COMPONENTS

art. **CASTD**

FINITURE STRUTTURA

FRAMEWORK FINISHES

verniciature_coatings

Le Acque di Cielo

- OL - Oltremare
- SM - Smeraldo
- AL - Alga
- CO - Corallo
- NI - Ninfea
- AM - Anemone

- NM - Nero Matt
- CM - Cemento



art. **CALAR**

FINITURE LAVABO

WASHBASIN SHELF FINISHES

Le Acque di Cielo

- OL - Oltremare
- SM - Smeraldo
- AL - Alga
- CO - Corallo
- NI - Ninfea
- AM - Anemone

art. **CAPIDE**

FINITURE PIANO IN LEGNO

BOTTOM WOODEN SHELF FINISHES

essenze legno/wood essences

- RS - Rovere Sbiancato
- RN - Rovere Naturale
- RG - Rovere Grigio
- RO - Rovere Nero
- EU - Eucalipto

art. **CAPIDM**

FINITURE PIANO IN PIETRA

STONE BOTTOM SHELF FINISHES

- AZ - Azul Noche

N.B. Il lavabo ha 1 foro predisposto 9 fori, su richiesta può essere prodotto senza foro

N.B. The washbasin has 1 hole prepared 9 holes ; may be made without holes upon request

DATA
DATE

FIRMA DEL CLIENTE
SIGNATURE

ATTENZIONE:
La rappresentazione delle finiture è puramente indicativa. Verificare le finiture con le relative cartelle.

Ogni oggetto possiede la peculiarità di essere elaborato secondo principi puramente tradizionali, in modo da garantirne l'assoluta originalità ed unicità. Le eventuali piccole variazioni di colore, tono o venature fra gli articoli sono da considerarsi pregi e non difetti, in quanto garanzia della fattura manuale del prodotto, che fa di ogni oggetto Cielo un pezzo unico ed esclusivo, lontano dall'omologazione industriale. In fase d'ordine si intendono, pertanto, accettate tali tolleranze che non possono dare adito a contestazioni di alcun genere.

Verificare sempre le disponibilità e i tempi di consegna con il commerciale.

ATTENTION:
The representation of the finishes is merely indicative. Please choose the finishes using the folders.

Every item possesses that particular feature of being processed according to purely traditional principles that guarantee its absolute originality and uniqueness. The small variations in colour, hues or streaks on the items are to be considered as qualities and not defects, since they warranty the handcrafted processing which makes each Cielo item a unique and exclusive piece that cannot be compared to industrial standardization. When making the order, the client implicitly accepts those various features that may give rise to claims of any sort.

Always check the availability and delivery time with the commercial department.

Modulo Ordine Catino Rettangolare con cassetto

Catino Rettangolare with drawer Order Form

cielo

CLIENTE/client: ORD. REF.:

QUANTITA'/quantity: EMAIL:

INDICARE CON UN SEGNO LE FINITURE SCELTE PER I DIVERSI COMPONENTI

INDICATE WITH A TICK, THE CHOOSEN FINISHES FOR ALL THE COMPONENTS

art. **CASTD**

FINITURE STRUTTURA

FRAMEWORK FINISHES

verniciature_coatings

Le Acque di Cielo

- OL - Oltremare
- SM - Smeraldo
- AL - Alga
- CO - Corallo
- NI - Ninfea
- AM - Anemone

- NM - Nero Matt
- CM - Cemento



art. **CALAR**

FINITURE LAVABO

WASHBASIN SHELF FINISHES

Le Acque di Cielo

- OL - Oltremare
- SM - Smeraldo
- AL - Alga
- CO - Corallo
- NI - Ninfea
- AM - Anemone

art. **CACDE**

FINITURE CASSETTO IN LEGNO

WOODEN DRAWER FINISHES

essenze legno/wood essences

- RG - Rovere Grigio
- RS - Rovere Sbiancato
- RN - Rovere Naturale
- RO - Rovere Nero
- EU - Eucalipto

N.B. Il lavabo ha 1 foro predisposto 9 fori, su richiesta può essere prodotto senza foro

N.B. The washbasin has 1 hole prepared 9 holes ; may be made without holes upon request

DATA
DATE

FIRMA DEL CLIENTE
SIGNATURE

ATTENZIONE:
La rappresentazione delle finiture è puramente indicativa. Verificare le finiture con le relative cartelle.









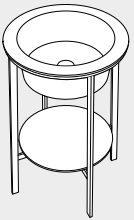

Ogni oggetto possiede la peculiarità di essere elaborato secondo principi puramente tradizionali, in modo da garantirne l'assoluta originalità ed unicità. Le eventuali piccole variazioni di colore, tono o venature fra gli articoli sono da considerarsi pregi e non difetti, in quanto garanzia della fattura manuale del prodotto, che fa di ogni oggetto Cielo un pezzo unico ed esclusivo, lontano dall'omologazione industriale. In fase d'ordine si intendono, pertanto, accettate tali tolleranze che non possono dare adito a contestazioni di alcun genere.

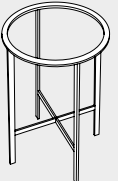
Verificare sempre le disponibilità e i tempi di consegna con il commerciale.

ATTENTION:
The representation of the finishes is merely indicative. Please choose the finishes using the folders.

Every item possesses that particular feature of being processed according to purely traditional principles that guarantee its absolute originality and uniqueness. The small variations in colour, hues or streaks on the items are to be considered as qualities and not defects, since they warranty the handcrafted processing which makes each Cielo item a unique and exclusive piece that cannot be compared to industrial standardization. When making the order, the client implicitly accepts those various features that may give rise to claims of any sort.

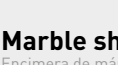
Always check the availability and delivery time with the commercial department.

Catino Tondo	Size (cm)	Product code	Net weight (kg)	Finishes	Euro	Pz.	Pz.
	Medidas Dimensions Maße Размеры	Artículo Article Artikel Артикул	Peso neto Poids net Reingewicht вес нетто	Acabados Finitions Farbe Отделки	Евро	pallet Italia	pallet Cont.
 Ceramic washbasin Lavabo de cerámica Lavabo en céramique Waschbecken aus Keramik Керамическая раковина	Ø50 x 18h	CALAT(x)*	9,65	 Le Acque di Cielo *	703,00		
 Steel framework Estructura de acero Structure en acier Stahlgestell Стальной каркас	Ø 50	CASTT(x)*	15,50	 Le Acque di Cielo *  *X = NM Matt Black  *X = CM Cemento	846,00 781,00 781,00		
 Ceramic shelf Encimera de cerámica Plaque en céramique Regal aus keramik Керамическая столешница	Ø44 x 1,8h	CAPIT(x)*	5,25	 Le Acque di Cielo *	215,00		
 Marble shelf Encimera de mármol Plaque en céramique Marmor Regal Столешница из мрамора	Ø44 x 1,8h	CAPITM(x)*	8,50	 *X = AZ Azul Noche	502,00		













* Le Acque di Cielo  OL - Oltremare  SM - Smeraldo  AL - Alga  CO - Corallo  NI - Ninfea  AM - Anemone











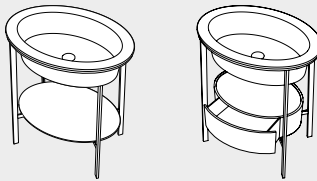
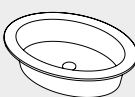



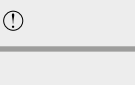

Technical symbols legend

 no tap holes
sin agujero para grifo \ sans orifice robinet
ohne Hahnloch \ без отверстия под смеситель

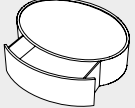
 without overflow
sin rebosadero \ sans trop-plein
ohne Überlauf \ без слива-перелива

 mandatory: framework + shelf
obligatoire: structure + encimera \ obligatoria: estructura + plaque
obligatorische: Stahlgestell + Regal \ обязательное: Стальной каркас + столешница

Drains and siphons	Product code	Net weight (kg)	Finishes	Euro
	Artículo Article Artikel Артикул	Peso neto Poids net Reingewicht вес нетто	Acabados Finitions Farbe Отделки	Евро
 Universal click-clack drain in CHROME with ceramic lid Válvula universal click-clack Cromado con tapa en cerámica \ Bonde universelle clic-clac Chromé avec clapet en céramique \ Universal-Abflussgarnitur Click-Clack Chrom mit Keramikstopfen \ Универсальный донный клапан click/clack хром с керамической крышкой	PIL01(x)*	0,40	 Le Acque di Cielo *	120,00
 Universal click-clack drain in BLACK MATT finish with ceramic lid Válvula universal click-clack Negro Matt con tapa en cerámica \ Bonde universelle clic-clac Noir Mat avec clapet en céramique \ Universal-Abflussgarnitur Click-Clack Matt Schwarz mit Keramikstopfen \ Универсальный донный клапан click/clack черный матовый с керамической крышкой	PIL01NM(x)*	0,40	 Le Acque di Cielo *	146,00
 Universal click-clack drain in CEMENTO finish with ceramic lid Válvula universal click-clack Cemento con tapa en cerámica \ Bonde universelle clic-clac Cemento avec clapet en céramique \ Universal-Abflussgarnitur Click-Clack Cement mit Keramikstopfen \ Универсальный донный Cemento click/clack с керамической крышкой	PIL01CM(x)*	0,40	 Le Acque di Cielo *	146,00
 CHROMED siphon Sifone Cromado \ Siphon Chromé \ Siphon Verchromt \ сифон Chrome	SISP	0,93	 Chrome	120,00
 MATT BLACK siphon Sifone Negro Mate \ Siphon Noir Mat \ Siphon Schwarz Matt \ Сифон Черный матовый	SIFN	0,93	 Matt Black	175,00
 CEMENTO siphon Sifone Cemento \ Siphon Cemento \ Siphon Cemento \ сифон Cemento	SIFCM	0,93	 Cemento	175,00

Catino Ovale	Size (cm) Medidas Dimensions Maße Размеры	Product code Artículo Article Artikel Артикул	Net weight (kg) Peso neto Poids net Reingewicht вес нетто	Finishes Acabados Finitions Farbe Отделки	Euro Евро	Pz. pallet Italia	Pz. pallet Cont.
							
 Ceramic washbasin Lavabo de cerámica Lavabo en céramique Waschbecken aus Keramik Керамическая раковина	70 x 50 x 18h	CALAO(x)*	12,70	 Le Acque di Cielo *	798,00		
 Steel framework Estructura de acero Structure en acier Stahlgestell Стальной каркас	70 x 50	CASTO(x)*	15,00	 Le Acque di Cielo *  *X = NM Matt Black  *X = CM Cemento	989,00 923,00 923,00		
 Ceramic shelf Encimera de cerámica Plaque en céramique Regal aus Keramik Керамическая столешница	65 x 45 x 1,8h	CAPIO(x)*	7,60	 Le Acque di Cielo *	265,00		
 Marble shelf Encimera de mármol Plaque en céramique Marmor Regal Столешница из мрамора	65 x 45 x 1,8h	CAPIOM(x)*	14,00	 *X = AZ Azul Noche	697,00		
 Drawer in wooden finish Cajón de madera Tiroir en bois Holzschubfach Ящик с отделкой натуральным шпоном	56 x 40 x 16,5h	CACOE(x)*	10,00	 *X = RN - Rovere Naturale  *X = RS - Rovere Sbiancato  *X = RO - Rovere Nero  *X = RG - Rovere Grigio  *X = EU - Eucalipto	1099,00 1359,00		











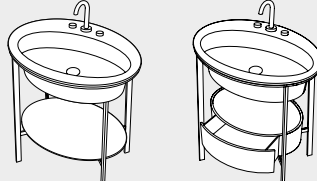
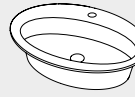

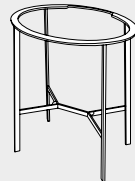



* Le Acque di Cielo  OL - Oltremare  SM - Smeraldo  AL - Alga  CO - Corallo  NI - Ninfea  AM - Anemone

Technical symbols legend

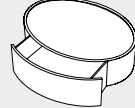
 **no tap holes**
sin agujero para grifo \ sans orifice robinet
ohne Hahnloch \ без отверстия под смеситель

 **without overflow**
sin rebosadero \ sans trop-plein
ohne Überlauf \ без слива-перелива

 **mandatory: framework + shelf or drawer**
obligatoire: structure + encimera o cajón \ obligatoria: estructura + plaque ou tiroir
obligatorische: Stahlgestell + Regal oder Schubfach \ обязательное: Стальной каркас + столешница или ящик

Catino Ovale with one hole	Size (cm) Medidas Dimensions Maße Размеры	Product code Artículo Article Artikel Артикул	Net weight (kg) Peso neto Poids net Reingewicht вес нетто	Finishes Acabados Finitions Farbe Отделки	Euro Евро	Pz. pallet Italia	Pz. pallet Cont.
							
 Ceramic washbasin with 1 hole Lavabo de cerámica monoagujero Lavabo en céramique avec un trou \ Waschbecken aus Keramik mit 1 Hahnloch \ Керамическая раковина на одно отверстие	70 x 50 x 18h	CALAOF(x)*	13,00	 Le Acque di Cielo *	798,00		
 Steel framework Estructura de acero Structure en acier Stahlgestell Стальной каркас	70 x 50	CASTO(x)*	15,00	 Le Acque di Cielo *  *X = NM Matt Black  *X = CM Cemento	989,00 923,00 923,00		
 Ceramic shelf Encimera de cerámica Plaque en céramique Regal aus Keramik Керамическая столешница	65 x 45 x 1,8h	CAPIO(x)*	7,60	 Le Acque di Cielo *	265,00		
 Marble shelf Encimera de mármol Plaque en céramique Marmor Regal Столешница из мрамора	65 x 45 x 1,8h	CAPIOM(x)*	14,00	 *X = AZ Azul Noche	697,00		
 Drawer in wooden finish Cajón de madera Tiroir en bois Holzschubfach Ящик с отделкой натуральным шпоном	56 x 40 x 16,5h	CACOE(x)*	10,00	 *X = RN - Rovere Naturale  *X = RS - Rovere Sbiancato  *X = RO - Rovere Nero  *X = RG - Rovere Grigio  *X = EU - Eucalipto	1099,00 1359,00		











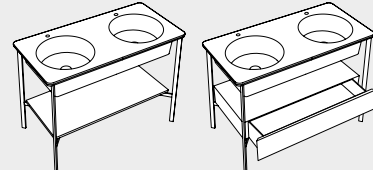
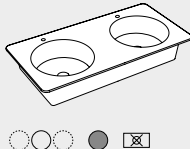







* Le Acque di Cielo  OL - Oltremare  SM - Smeraldo  AL - Alga  CO - Corallo  NI - Ninfea  AM - Anemone

Technical symbols legend

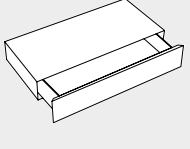
 **with 1 hole prepared 3 holes**
con 1 agujero pre-disueto para 3
avec un trou prédisposition à trois trous
mit 1-Loch auf 3-Loch durchschlagbar
одно отверстие с возможностью выполнения трех отверстий

 **without overflow**
sin rebosadero \ sans trop-plein
ohne Überlauf \ без слива-перелива

 **mandatory: framework + shelf or drawer**
obligatoire: structure + encimera o cajón \ obligatoria: estructura + plaque ou tiroir
obligatorische: Stahlgestell + Regal oder Schubfach \ обязательное: Стальной каркас + столешница или ящик

Catino Doppio	Size (cm) Medidas Dimensions Maße Размеры	Product code Artículo Article Artikel Артикул	Net weight (kg) Peso neto Poids net Reingewicht вес нетто	Finishes Acabados Finitions Farbe Отделки	Euro Евро	Pz. pallet Italia	Pz. pallet Cont.
							
 Ceramic washbasin Lavabo de cerámica Lavabo en céramique Washbecken aus Keramik Керамическая раковина	110 x 54 x 18h	CALAD(x)* CALADSF(x)* <small>no tap hole sin agujero - sans orifice - ohne Loch без отверстия</small>	34,00	 Le Acque di Cielo *	1155,00		
 Steel framework Estructura de acero Structure en acier Stahlgestell Стальной каркас	110 x 58,5	CASTD(x)*	23,50	 Le Acque di Cielo *  *X = NM Matt Black  *X = CM Cemento	1098,00 999,00 999,00		
 Shelf in wooden finish Encimera de madera \ Plan en bois \ Holzregal \ столешница с отделкой натуральным шпоном	100 x 46 x 1,8h	CAPIDE(x)*	8,00	Essenze  *X = RN - Rovere Naturale  *X = RS - Rovere Sbiancato  *X = RO - Rovere Nero  *X = RG - Rovere Grigio	449,00		
 Marble shelf Encimera de mármol \ Plaque en céramique \ Marmor Regal Столешница из мрамора	100 x 44 x 1,8h	CAPIDM(x)*	23,50	 *X = AZ Azul Noche	899,00		
 Drawer in wooden finish Cajón de madera Tiroir en bois Holzschubfach Ящик с отделкой натуральным шпоном	100 x 46 x 16,8h	CACDE(x)*	24,50	Essenze  *X = RN - Rovere Naturale  *X = RS - Rovere Sbiancato  *X = RO - Rovere Nero  *X = RG - Rovere Grigio	1099,00		
				 *X = EU - Eucalipto	1298,00		

* Le Acque di Cielo   OL - Oltremare  SM - Smeraldo  AL - Alga  CO - Corallo  NI - Ninfea  AM - Anemone











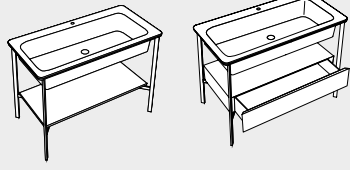
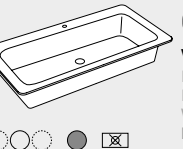







Technical symbols legend

 **with 2 holes prepared 6 holes**
con 2 agujeros pre-disueto para 6
avec 1 trou prédisposition à 6 trous
mit 2-Loch auf 6-Loch durchschlagbar
два отверстия с возможностью
выполнения шести отверстий

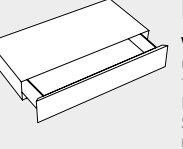
 **no tap hole on request**
sin agujero, solo a petición
sans orifice sur demande
ohne Überlauf
без отверстия под смеситель
по запросу

 **without overflow**
sin rebosadero
sans trop-plein
без слива-перелива

 **mandatory: framework + shelf or drawer**
obligatoire: structure + encimera o cajón \ obliga-
toria: estructura + plaque ou tiroir \ obligatorische:
Stahlgestell + Regal oder Schubfach \ обязательное:
Стальной каркас + столешница или ящик

Catino Rettangolare	Size (cm) Medidas Dimensions Maße Размеры	Product code Artículo Article Artikel Артикул	Net weight (kg) Peso neto Poids net Reingewicht вес нетто	Finishes Acabados Finitions Farbe Отделки	Euro Евро	Pz. pallet Italia	Pz. pallet Cont.
							
 Ceramic washbasin Lavabo de cerámica Lavabo en céramique Washbecken aus Keramik Керамическая раковина	110 x 54 x 18h	CALAR(x)* CALARSF(x)* <small>no tap hole sin agujero - sans orifice - ohne Loch без отверстия</small>	35,00	 Le Acque di Cielo *	1155,00		
 Steel framework Estructura de acero Structure en acier Stahlgestell Стальной каркас	110 x 58,5	CASTD(x)*	23,50	 Le Acque di Cielo *  *X = NM Matt Black  *X = CM Cemento	1098,00 999,00 999,00		
 Shelf in wooden finish Encimera de madera \ Plan en bois \ Holzregal \ столешница с отделкой натуральным шпоном	100 x 46 x 1,8h	CAPIDE(x)*	8,00	Essenze  *X = RN - Rovere Naturale  *X = RS - Rovere Sbiancato  *X = RO - Rovere Nero  *X = RG - Rovere Grigio	449,00		
 Marble shelf Encimera de mármol \ Plaque en céramique \ Marmor Regal Столешница из мрамора	100 x 44 x 1,8h	CAPIDM(x)*	23,50	 *X = AZ Azul Noche	899,00		
 Drawer in wooden finish Cajón de madera Tiroir en bois Holzschubfach Ящик с отделкой натуральным шпоном	100 x 46 x 16,8h	CACDE(x)*	24,50	Essenze  *X = RN - Rovere Naturale  *X = RS - Rovere Sbiancato  *X = RO - Rovere Nero  *X = RG - Rovere Grigio	1099,00		
				 *X = EU - Eucalipto	1298,00		

* Le Acque di Cielo   OL - Oltremare  SM - Smeraldo  AL - Alga  CO - Corallo  NI - Ninfea  AM - Anemone

Technical symbols legend

 **with 1 hole prepared 9 holes**
con 1 agujero pre-disueto para 9
avec un trou prédisposition à trois trous
mit 1-Loch auf 9-Loch durchschlagbar
одно отверстие с возможностью
выполнения трех отверстий

 **no tap hole on request**
sin agujero, solo a petición
sans orifice sur demande
ohne Überlauf
без отверстия под смеситель
по запросу

 **without overflow**
sin rebosadero \ sans trop-plein
ohne Überlauf \ без слива-перелива

 **mandatory: framework + shelf or drawer**
obligatoire: structure + encimera o cajón \ obliga-
toria: estructura + plaque ou tiroir \ obligatorische:
Stahlgestell + Regal oder Schubfach \ обязательное:
Стальной каркас + столешница или ящик

Delfo

lavabo + top ovale + mobile versione liscia

washbasin + oval top + smooth version cabinet or shelf

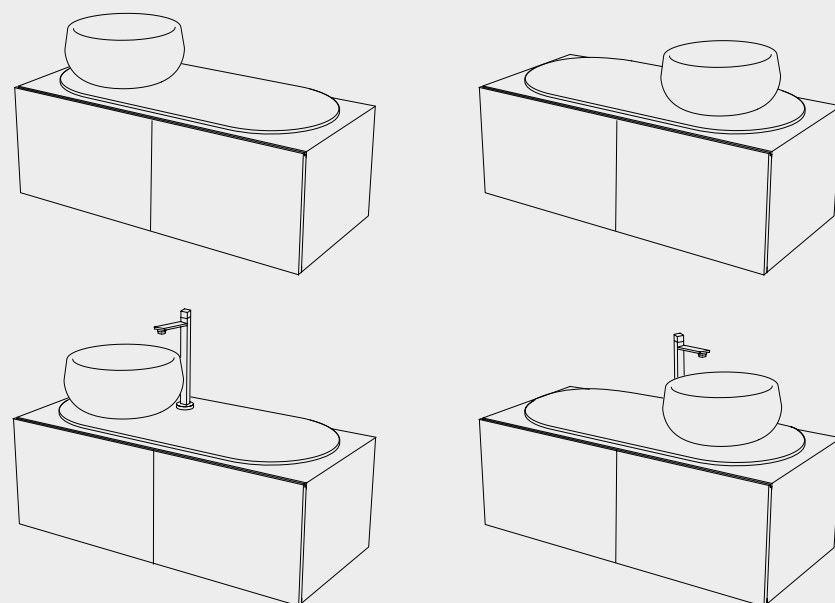
**lavabo + top ovale + mobile con anta frontale in listelli di massello triangolari in essenza**

washbasin + oval top + cabinet with front door in solid triangular wooden strips

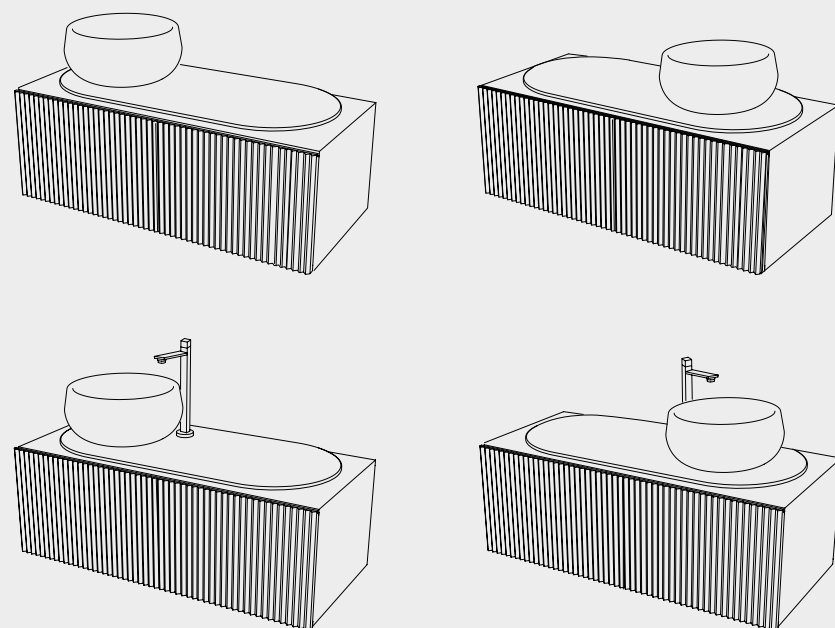

Modulo Ordine Delfo

Delfo Order Form

cielo

CLIENTE/client: ORD. REF.: QUANTITA'/quantity: EMAIL: **INDICARE CON UN SEGNO LE FINITURE SCELTE PER I DIVERSI COMPONENTI**

INDICATE WITH A TICK, THE CHOSEN FINISHES FOR ALL THE COMPONENTS

art. **BATO****FINITURE LAVABO**

WASHBASIN SHELF FINISHES

Le Acque di Cielo

- OL - Oltremare
- SM - Smeraldo
- AL - Alga
- CO - Corallo
- NI - Ninfea
- AM - Anemone

art. **DEPIO****FINITURE TOP OVALE**

OVAL TOP FINISHES

Le Acque di Cielo

- OL - Oltremare
- SM - Smeraldo
- AL - Alga
- CO - Corallo
- NI - Ninfea
- AM - Anemone

art. **DECDE****FINITURE MOBILE IN LEGNO CON ANTA FRONTALE IN LISTELLI**

WOODEN CABINET FINISHES WITH FRONT DOOR IN SOLID WOODEN STRIPS

essenze legno/wood essences

- RO - Rovere Nero
- RG - Rovere Grigio
- RS - Rovere Sbiancato
- RN - Rovere Naturale
- EU - Eucalipto

art. **DECE****FINITURE MOBILE IN LEGNO VERSIONE LISCIA**

WOODEN CABINET FINISHES - SMOOTH VERSION

essenze legno/wood essences

- RO - Rovere Nero
- RG - Rovere Grigio
- RS - Rovere Sbiancato
- RN - Rovere Naturale
- EU - Eucalipto

N.B. Foro rubinetto su richiesta (posizione obbligatoria) \ Tap-Faucet hole on request (mandatory position)DATA
DATEFIRMA DEL CLIENTE
SIGNATUREATTENZIONE:
La rappresentazione delle finiture è puramente indicativa. Verificare le finiture con le relative cartelle.



Ogni oggetto possiede la peculiarità di essere elaborato secondo principi puramente tradizionali, in modo da garantirne l'assoluta originalità ed unicità. Le eventuali piccole variazioni di colore, tono o venature fra gli articoli sono da considerarsi pregi e non difetti, in quanto garanzia della fattura manuale del prodotto, che fa di ogni oggetto Cielo un pezzo unico ed esclusivo, lontano dall'omologazione industriale. In fase d'ordine si intendono, pertanto, accettate tali tolleranze che non possono dare adito a contestazioni di alcun genere.





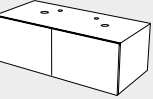
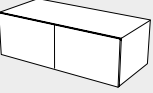
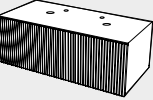
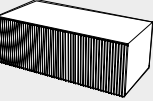

Verificare sempre le disponibilità e i tempi di consegna con il commerciale.

ATTENTION:
The representation of the finishes is merely indicative. Please choose the finishes using the folders.

Every item possesses that particular feature of being processed according to purely traditional principles that guarantee its absolute originality and uniqueness. The small variations in colour, hues or streaks on the items are to be considered as qualities and not defects, since they warranty the handcrafted processing which makes each Cielo item a unique and exclusive piece that cannot be compared to industrial standardization. When making the order, the client implicitly accepts those various features that may give rise to claims of any sort.

Always check the availability and delivery time with the commercial department.

Delfo	Size (cm) Medidas Dimensions Maße Размеры	Product code Artículo Article Artikel Артикул	Net weight(Kg) Peso neto Poids net Reingewicht вес нетто	Finishes Acabados Finitions Farbe Отделки	Euro Евро
 <p>On top bowl h19 Tino (recommended) Cubela de apoyo h19 Tino (aconsejado) Vasque à poser h19 Tino (informé) Aufsatzbecken h19 Tino (empfohlen) Накладная чаша h19 Tino (рекомендуется)</p>	Ø43 x 19 h	BATO(X)*	10,30	● Le Acque di Cielo *	644,00
 <p>Ceramic oval countertop, reversible Top ovalado en cerámica reversible \ Plan ovale en céramique réversible \ Ovale Platte aus Keramik reversibel \ Овальная керамическая столешница</p> <p>N.B. Tap/Faucet hole on request (mandatory position – see technical data sheet and order form). \ Orificio grifo a petición [posición obligada- véase ficha técnica y módulo de pedido] \ N.B. : Trou de robinet sur demande [position obligée – voir fiche technique et bon de commande] \ Hinweis: Hahnloch auf Anfrage [Position obligatorisch – siehe technisches Datenblatt und Bestellformular] \ P.S. Отверстие под смеситель по запросу (возможное место расположения отверстия – проверьте на технической карте изделия и модуле заказа)</p>	107 x 47 x 2h	DEPIO(X)*	17,00	● Le Acque di Cielo *	385,00
 <p>Cabinet in wooden finish Mueble en madera \ Meuble bois \ Möbel aus Holz \ Тумба в деревянной отделке</p>	113 x 52 x 40h	DECE(X)*	45,70	● Essenze Rovere # ● *X = EU - Eucalipto	2189,00 2585,00
 <p>Cabinet in wooden finish without holes Mueble en madera sin agujero \ Meuble bois sans orifice \ Möbel aus Holz ohne Hahnloch \ Тумба в деревянной отделке без отверстия</p>	113 x 52 x 40h	DECESF(X)*	46,00	● Essenze Rovere # ● *X = EU - Eucalipto	2408,00 2843,00
 <p>Cabinet with front door in solid triangular wooden strips Mueble con puerta frontal con tiras de madera maciza triangulares \ Meuble avec porte frontale ornée de listels triangulaires en essence de bois massif \ Möbel mit Fronttür aus dreieckigen Massivholzleisten \ Тумба с передней дверцей из массива бруса треугольной формы из натурального шпона дерева</p>	113 x 52 x 40h	DECDE(X)*	44,50	● Essenze Rovere # ● *X = EU - Eucalipto	4345,00 4895,00
 <p>Cabinet with front door in solid triangular wooden strips without holes Mueble con puerta frontal con tiras de madera maciza triangulares sin agujero \ Meuble avec porte frontale ornée de listels triangulaires en essence de bois massif sans orifice \ Möbel mit Fronttür aus dreieckigen Massivholzleisten ohne Hahnloch \ Тумба с передней дверцей из массива бруса треугольной формы из натурального шпона дерева без отверстия</p>	113 x 52 x 40h	DECDESF(X)*	44,80	● Essenze Rovere # ● *X = EU - Eucalipto	4779,00 5385,00

Drains and siphons	Product code Artículo Article Artikel Артикул	Net weight(Kg) Peso neto Poids net Reingewicht вес нетто	Finishes Acabados Finitions Farbe Отделки	Euro Евро
 <p>Universal click-clack drain in CHROME with ceramic lid Válvula universal click-clack Cromado con tapa en cerámica \ Bonde universelle clic-clac Chromé avec clapet en céramique \ Universal-Abflussgarnitur Click-Clack Chrom mit Keramikstopfen \ Универсальный донный клапан click/clack хром с керамической крышкой</p>	PIL01(X)*	0,40	● Le Acque di Cielo *	120,00
 <p>Universal click-clack drain in MATT BLACK finish with ceramic lid Válvula universal click-clack Negro Matt con tapa en cerámica \ Bonde universelle clic-clac Noir Mat avec clapet en céramique \ Universal-Abflussgarnitur Click-Clack Matt Schwarz mit Keramikstopfen \ Универсальный донный клапан click/clack черный матовый с керамической крышкой</p>	PIL01NM(X)*	0,40	● Le Acque di Cielo *	146,00
 <p>Universal click-clack drain in CEMENTO finish with ceramic lid Válvula universal click-clack Cemento con tapa en cerámica \ Bonde universelle clic-clac Cemento avec clapet en céramique \ Universal-Abflussgarnitur Click-Clack Cement mit Keramikstopfen \ Универсальный донный клапан click/clack с керамической крышкой</p>	PIL01CM(X)*	0,40	● Le Acque di Cielo *	146,00
 <p>CHROMED siphon Sifone Cromado \ Siphon Chromé \ Siphon Verchromt \ сифон Chrome</p>	SISP	0,93	● Chrome	120,00
 <p>MATT BLACK siphon Sifone Negro Mate \ Siphon Noir Mat \ Siphon Schwarz Matt \ Сифон Черный матовый</p>	SIFN	0,93	● Matt Black	175,00
 <p>CEMENTO siphon Sifone Cemento \ Siphon Cemento \ Siphon Cemento \ сифон Cemento</p>	SIFCM	0,93	● Cemento	175,00

Technical symbols legend

Símbolos técnicos clave | Légende symboles techniques | Technische Zeichenerklärung | Перечень технических символов

 **all sides are enamelled**
con todos los lados esmaltados
avec tous les côtés émaillés
alle Seiten glasiert
все стороны покрыты эмалью

 **no tap holes**
sin agujero para grifo
sans orifice robinet
ohne Hahnloch
без отверстия под смеситель

 **without overflow**
sin rebosadero
sans trop-plein
ohne Überlauf
без слива-перелива

 **on top installation**
instalación de apoyo
installation à partir du plan
Montage auf Platte
установка на столешницу

 **mandatory combination: on top washbasin + top + cabinet with holes**
combinaison obligatoire: cubela de apoyo + encimera + mueble los agujeros \ combinación obligatoria: vasque à poser + plan + meuble con orifice \ obligatorische Kombination: Aufsatzbecken + Holzregal + Möbel mit Hahnloch \ обязательное сочетание: Накладная + столешница + Тумба con отверстия

* Le Acque di Cielo ● OL - Oltremare ● SM - Smeraldo ● AL - Alga ● CO - Corallo ● NI - Ninfea ● AM - Anemone

Essenze Rovere ● RS - Rovere Sbiancato ● RN - Rovere Naturale ● RG - Rovere Grigio ● RO - Rovere Nero

Modulo Ordine Plinio con cassetto

Plinio with drawer Order Form

cielo

CLIENTE/client: ORD. REF.:

QUANTITA'/quantity: EMAIL:

INDICARE CON UN SEGNO LE FINITURE SCELTE PER I DIVERSI COMPONENTI

INDICATE WITH A TICK, THE CHOSEN FINISHES FOR ALL THE COMPONENTS

art. **PNST**

FINITURE STRUTTURA IN ACCIAIO

STEEL FRAMEWORK FINISHES

verniciature_coatings

Le Acque di Cielo

- OL - Oltremare
- SM - Smeraldo
- AL - Alga
- NM - Nero Matt
- CM - Cemento
- CO - Corallo
- NI - Ninfea
- AM - Anemone

cm 140 x 46 x h82,5 cm 115 x 46 x h82,5 cm 85 x 46 x h82,5

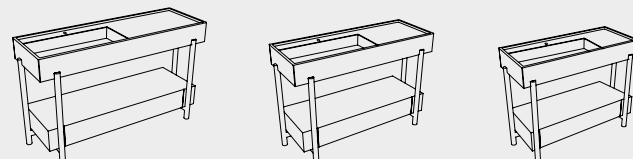

art. **PNLA**

FINITURE LAVABO

WASHBASIN FINISHES

Le Acque di Cielo

- OL - Oltremare
- SM - Smeraldo
- AL - Alga
- CO - Corallo
- NI - Ninfea
- AM - Anemone

art. **PNSC10** YES NO

FINITURE CESTE IN CUOIO

BASKETS IN LEATHER IN FINISHES

- BI - Bianco \ White
- NA - Cuio Naturale \ Leather
- NE - Nero \ Black

art. **PNSTE**

FINITURE STRUTTURA IN LEGNO

MASSELLO

SOLID WOOD FRAMEWORK FINISHES

essenze legno/wood essences

- RO - Rovere Nero
- RG - Rovere Grigio
- RS - Rovere Sbiancato
- RN - Rovere Naturale

art. **PNCE**

FINITURE CASSETTO IN LEGNO

DRAWER WOODEN FINISHES

essenze legno/wood essences

- RO - Rovere Nero
- RG - Rovere Grigio
- RS - Rovere Sbiancato
- RN - Rovere Naturale

N.B. Il lavabo è monoforo predisposto 3 fori, su richiesta può essere prodotto senza foro

N.B. The washbasin has 1 hole prepared 3 holes ; may be made without holes upon request

DATA
DATE

FIRMA DEL CLIENTE
SIGNATURE

ATTENZIONE:
La rappresentazione delle finiture è puramente indicativa. Verificare le finiture con le relative cartelle.

ATTENTION:
The representation of the finishes is merely indicative. Please choose the finishes using the folders.
Every item possesses that particular feature of being processed according to purely traditional principles that guarantee its absolute originality and uniqueness. The small variations in colour, hues or streaks on the items are to be considered as qualities and not defects, since they warranty the handcrafted processing which makes each Cielo item a unique and exclusive piece that cannot be compared to industrial standardization. When making the order, the client implicitly accepts those various features that may give rise to claims of any sort.

Verificare sempre le disponibilità e i tempi di consegna con il commerciale.

Always check the availability and delivery time with the commercial department.

Modulo Ordine Plinio con piano

Plinio with shelf Order Form

cielo

CLIENTE/client: ORD. REF.:

QUANTITA'/quantity: EMAIL:

INDICARE CON UN SEGNO LE FINITURE SCELTE PER I DIVERSI COMPONENTI

INDICATE WITH A TICK, THE CHOSEN FINISHES FOR ALL THE COMPONENTS

art. **PNST**

FINITURE STRUTTURA IN ACCIAIO

STEEL FRAMEWORK FINISHES

verniciature_coatings

Le Acque di Cielo

- OL - Oltremare
- SM - Smeraldo
- AL - Alga
- NM - Nero Matt
- CM - Cemento
- CO - Corallo
- NI - Ninfea
- AM - Anemone

cm 140 x 46 x h82,5 cm 115 x 46 x h82,5 cm 85 x 46 x h82,5

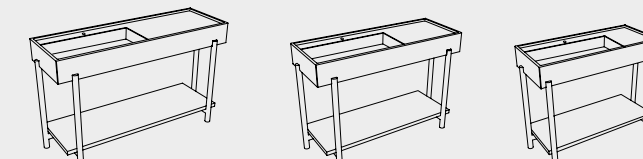

art. **PNLA**

FINITURE LAVABO

WASHBASIN FINISHES

Le Acque di Cielo

- OL - Oltremare
- SM - Smeraldo
- AL - Alga
- CO - Corallo
- NI - Ninfea
- AM - Anemone

art. **PNSTE**

FINITURE STRUTTURA IN LEGNO

MASSELLO

SOLID WOOD FRAMEWORK FINISHES

essenze legno/wood essences

- RO - Rovere Nero
- RG - Rovere Grigio
- RS - Rovere Sbiancato
- RN - Rovere Naturale

art. **PNPIE**

FINITURE PIANO IN LEGNO

SHELF WOODEN FINISHES

essenze legno/wood essences

- RO - Rovere Nero
- RG - Rovere Grigio
- RS - Rovere Sbiancato
- RN - Rovere Naturale

art. **PNSC** YES NO

FINITURE CESTE IN CUOIO

BASKETS IN LEATHER IN FINISHES

- BI - Bianco \ White
- NA - Cuio Naturale \ Leather
- NE - Nero \ Black

N.B. Il lavabo è monoforo predisposto 3 fori, su richiesta può essere prodotto senza foro

N.B. The washbasin has 1 hole prepared 3 holes ; may be made without holes upon request

DATA
DATE











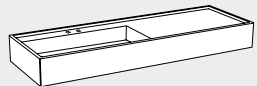



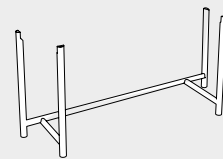

FIRMA DEL CLIENTE
SIGNATURE





ATTENZIONE:
La rappresentazione delle finiture è puramente indicativa. Verificare le finiture con le relative cartelle.









ATTENTION:
The representation of the finishes is merely indicative. Please choose the finishes using the folders.
Every item possesses that particular feature of being processed according to purely traditional principles that guarantee its absolute originality and uniqueness. The small variations in colour, hues or streaks on the items are to be considered as qualities and not defects, since they warranty the handcrafted processing which makes each Cielo item a unique and exclusive piece that cannot be compared to industrial standardization. When making the order, the client implicitly accepts those various features that may give rise to claims of any sort.

Verificare sempre le disponibilità e i tempi di consegna con il commerciale.

Always check the availability and delivery time with the commercial department.

Plinio	Size (cm) Medidas Dimensions Maße Размеры	Product code Artículo Article Artikel Артикул	Net weight(Kg) Peso neto Poids net Reingewicht вес нетто	Finishes Acabados Finitions Farbe Отделки	Euro Евро
 <p>Ceramic washbasin with 1 hole Lavabo de cerámica monoagujero \ Lavabo en céramique avec un trou Waschbecken aus Keramik mit 1 Hahnloch \ Керамическая раковина на одно отверстие</p>	140 x 46 x 15,5 h	PNLA(X)* PNLASF(X)* no tap hole sin agujero, sans orifice, ohne Loch без отверстия	41,00	 Le Acque di Cielo *	1529,00
	115 x 46 x 16 h	PNLA115(X)* PNLA115SF(X)* no tap hole sin agujero, sans orifice, ohne Loch без отверстия	34,00	 Le Acque di Cielo *	1262,00
	85 x 46 x 15,5 h	PNLA85(X)* PNLA85SF(X)* no tap hole sin agujero, sans orifice, ohne Loch без отверстия	25,00	 Le Acque di Cielo *	1084,00
<p>For on top installation customers are advised to the require the "RETTIFICA" option. Para instalaciones de apoyo se aconseja usar la opción "RETTIFICA" / Pour l'installation à poser on conseille l'option "RETTIFICA" / Bei Aufsatzmontage bitte die Option "RETTIFICA" anfragen / При установке на столешницу рекомендуется запросить опцию "RETTIFICA".</p>		RETTIFICA GRINDING			10,00
 <p>Steel framework Estructura en acero \ Structure en acier \ Gestell aus Stahl \ Структура стальная</p> <p>framework mandatory with washbasin and shelf/drawer estructura obligatoria con lavabo y encimera/cajón structure obligatoire avec évier et dessus ou tiroir obligatorische Struktur mit Spüle und Platte oder Schublade обязательная конструкция с раковины и верхом или ящиком</p>	145 x 48 x 71 h	PNST(X)*	15,00	 Le Acque di Cielo *  *X = NM - Matt Black  *X = CM - Cemento	1162,00 1070,00 1087,00
	120 x 48 x 71 h	PNST115(X)*	12,00	 Le Acque di Cielo *  *X = NM - Matt Black  *X = CM - Cemento	1107,00 1018,00 1087,00
	90 x 48 x 71 h	PNST85(X)*	11,00	 Le Acque di Cielo *  *X = NM - Matt Black  *X = CM - Cemento	996,00 887,00 961,00
	145 x 48 x 71 h	PNSTE(X)*	12,00	 EsSENZE ROVERE #	1463,00
	120 x 48 x 71 h	PNST115E(X)*	10,00	 EsSENZE ROVERE #	1426,00
	90 x 48 x 71 h	PNST85E(X)*	8,00	 EsSENZE ROVERE #	1426,00
<p>Wooden framework in solid wood Estructura en MADERA MACIZA \ Structure en bois massif \ Gestell aus MASSIVHOLZ \ Структура из массива дерева</p>					

EsSENZE ROVERE  **RS - Rovere Sbiancato**  **RN - Rovere Naturale**  **RG - Rovere Grigio**  **R0 - Rovere Nero*** **Le Acque di Cielo**  **OL - Oltremare**  **SM - Smeraldo**  **AL - Alga**  **CO - Corallo**  **NI - Ninfea**  **AM - Anemone**



Plinio	Size (cm) Medidas Dimensions Maße Размеры	Product code Artículo Article Artikel Артикул	Net weight(Kg) Peso neto Poids net Reingewicht вес нетто	Finishes Acabados Finitions Farbe Отделки	Euro Евро
 <p>Shelf in wooden finish Encimera de madera \ Plan en bois \ Holzregal \ столешница с отделкой \ натуральным шпоном</p>	135 x 42 x 2 h	PNPIE(X)*	7,00	 EsSENZE ROVERE #	385,00
	110 x 42 x 2 h	PNPI115E(X)*	6,00	 EsSENZE ROVERE #	385,00
	80 x 42 x 2 h	PNPI85E(X)*	4,00	 EsSENZE ROVERE #	363,00
 <p>Drawer in wooden finish Cajón de madera \ Tiroir en bois \ Holzschubfach \ Ящик с отделкой натуральным шпоном</p>	135 x 42 x 18,5 h	PNCE(X)*	27,00	 EsSENZE ROVERE #	1469,00
	110 x 42 x 18,5 h	PNC115E(X)*	22,00	 EsSENZE ROVERE #	1389,00
	80 x 42 x 18,5 h	PNC85E(X)*	26,00	 EsSENZE ROVERE #	1343,00
 <p>Basket in leather h28 Cesta en cuero h28 \ Panier en cuir h28 \ Lederkorb h28 \ Корзина из кожи h28</p>	63 x 36 x 28 h	PNSC(X)*	3,00	 *X = BI - White  *X = NA - Leather  *X = NE - Black	761,00 761,00 761,00
 <p>Basket in leather h10 Cesta en cuero h10 \ Panier en cuir h10 \ Lederkorb h10 \ Корзина из кожи h10</p>	63 x 36 x 10 h	PNSC10(X)*	2,00	 *X = BI - White  *X = NA - Leather  *X = NE - Black	572,00 572,00 572,00

EsSENZE ROVERE  **RS - Rovere Sbiancato**  **RN - Rovere Naturale**  **RG - Rovere Grigio**  **R0 - Rovere Nero**

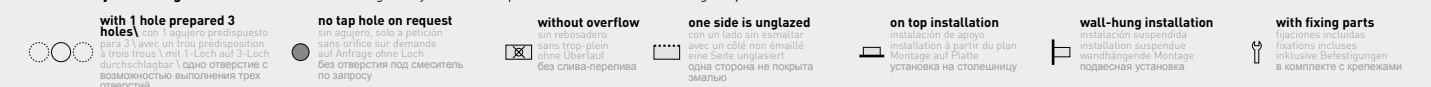
Technical symbols legend | Símbolos técnicos clave | Légende symboles techniques | Technische Zeichenerklärung | Перечень технических символов



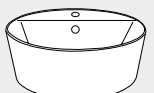

 **framework mandatory with washbasin and shelf/drawer**
estructura obligatoria con lavabo y encimera/cajón \ structure obligatoire avec évier et dessus ou tiroir
obligatorische Struktur mit Spüle und Platte oder Schublade \ обязательная конструкция с раковиной и верхом или ящиком

Le Bacinelle	Size (cm) Medidas Dimensions Maße Размеры	Product code Artículo Article Artikel Артикул	Net weight (kg) Peso neto Poids net Reingewicht вес нетто	Finishes Acabados Finitions Farbe Отделки	Euro Евро	Pz. pallet Italia	Pz. pallet Cont.
 <p>Eco 62 oval on top bowl Cubela de apoyo Eco oval 62 \ Vasque à poser Eco ovale 62 \ Aufsatzbecken Oval Eco 62 \ Раковина овальный Eco 62</p> <p>□ ⊗ ⊗ ⊞ ⊞</p>	62 x 45 x 18 h	BAECO(X)*	10,50	● Le Acque di Cielo *	762,00	14	28
 <p>Eco Small oval on top bowl Cubela de apoyo Eco Small \ Vasque à poser Eco Small \ Aufsatzbecken Runde Eco Small \ Раковина круглый Eco Small</p> <p>□ ⊗ ⊗ ⊞ ⊞</p>	58 x 42 x 16,5 h	BAECO58(X)*	10,00	● Le Acque di Cielo *	714,00	16	32
 <p>Era ø45 round on top bowl Cubela de apoyo Era ronda ø45 \ Vasque à poser Era tour ø45 \ Aufsatzbecken Runde Era ø45 \ Раковина круглый Era ø45</p> <p>□ ⊗ ⊗ ⊞ ⊞</p>	ø45 x 24 h	BAERA(X)*	13,00	● Le Acque di Cielo *	839,00	16	32
 <p>Era Small round on top bowl Cubela de apoyo Era Small \ Vasque à poser Era Small \ Aufsatzbecken Runde Era Small \ Раковина круглый Era Small</p> <p>□ ⊗ ⊗ ⊞ ⊞</p>	ø40 x 15 h	BAERA40(X)*	8,00	● Le Acque di Cielo *	637,00	26	52
 <p>Handy round on top bowl with one hole Lavabo Handy ronda con 1 agujero ø45 \ Lavabo Handy tour tour monotrou ø45 \ Aufsatzbecken Runde Handy ø45 1-Loch \ Раковина круглый Handy ø45 одно отверстие под смеситель</p> <p>□ ○ ● ⊞ ⊞</p>	ø45 x 16,8 h	HALAT45(X)* HALAT45SF(X)* no tap hole sin agujero \ sans orifice \ ohne Loch без отверстия	10,50	● Le Acque di Cielo *	648,00	20	34

* Le Acque di Cielo ● OL - Oltremare ● SM - Smeraldo ● AL - Alga ● CO - Corallo ● NI - Ninfea ● AM - Anemone



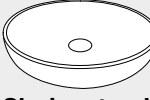

Technical symbols legend



□ all sides are enamelled con todos los lados esmaltados \ avec tous les côtés émaillés \ alle Seiten glasiert \ все стороны покрыты эмалью	⊗ no tap holes sin agujero para grifo \ sans orifice robinet ohne Hahnloch без отверстия под смеситель	○ one tap hole con 1 agujero monotrou 1-Loch одно отверстие под смеситель	● no tap hole on request sin agujero, solo a petición sans orifice sur demande auf Anfrage ohne Loch без отверстия под смеситель по запросу	⊞ with overflow con rebosadero avec trop-plein mit Überlauf с переливом	⊞ without overflow sin rebosadero sans trop-plein ohne Überlauf без слива-перелива	⊞ on top installation instalación de apoyo installation à partir du plan \ Montage auf Platte установка на столешницу
--	--	--	--	---	--	--

Le Bacinelle	Size (cm)	Product code	Net weight (kg)	Finishes	Euro	Pz.	Pz.
 <p>Tino h19 on top bowl Cubela de apoio h19 Tino \ Vasque à poser h19 Tino \ Aufsatzbecken h19 Tino \ Накладная чаша h19 Tino</p> <p>Medidas Dimensions Maße Размеры</p> <p>Artículo Article Artikel Артикул</p> <p>Peso neto Poids net Reingewicht вес нетто</p> <p>Acabados Finitions Farbe Отделки</p> <p>Евро</p> <p>pallet Italia</p> <p>pallet Cont.</p>	ø43 x 19 h	BATO(X)*	10,30	● Le Acque di Cielo *	644,00	26	52
 <p>Tina h26 on top bowl Cubela de apoio h26 Tina \ Vasque à poser h26 Tina \ Aufsatzbecken h26 Tina \ Накладная чаша h26 Tina</p>	ø45 x 26 h	BATA(X)*	11,90	● Le Acque di Cielo *	754,00	16	32
 <p>Shui on top bowl without overflow ø40 Cubela de apoyo sin demasiado lleno ø40 Vasque à poser sans trop plein ø40 Aufsatzbecken ohne Überlauf ø40 Накладная чаша без переливом ø40</p>	ø40 x 18,5 h	SHBA40(X)*	8,55	● Le Acque di Cielo *	654,00	26	52
 <p>Shui on top bowl without overflow ø45 Cubela de apoyo Shui sin demasiado lleno ø45 Vasque à poser Shui sans trop plein ø45 Aufsatzbecken ohne Überlauf Shui ø45 Накладная чаша без переливом Shui ø45</p>	ø45 x 12,5 h	SHBA45(X)*	9,05	● Le Acque di Cielo *	644,00	32	64

* Le Acque di Cielo ● OL - Oltremare ● SM - Smeraldo ● AL - Alga ● CO - Corallo ● NI - Ninfea ● AM - Anemone



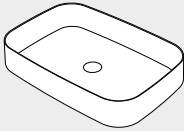
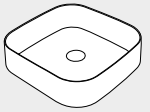
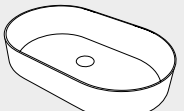
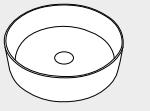

Technical symbols legend







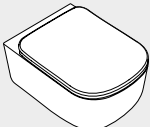

 all sides are enamelled con todos los lados esmaltados \ avec tous les côtés émaillés \ alle Seiten glasiert \ все стороны покрыты эмалью	 no tap holes sin agujero para grifo \ sans orifice robinet ohne Hahnloch без отверстия под смеситель	 without overflow sin rebosadero sans trop-plein ohne Überlauf без слива-перелива	 on top installation instalación de apoyo installation à partir du plan \ Montage auf Platte установка на столешницу
--	--	--	--

Shui Comfort	Size (cm)	Product code	Net weight (kg)	Finishes	Euro	Pz.	Pz.
 <p>Shui Comfort rectangular washbasin 60 x 40 Lavabo Shui Comfort rectangular 60 x 40 \ Lavabo Shui Comfort rectangulaire 60 x 40 \ Aufsatzbecken rechteckig Shui Comfort 60 x 40 \ Раковина прямоугольная Shui Comfort 60 x 40</p>	60 x 40 x 12,5 h	SHCOLAR60(X)*	10,35	● Le Acque di Cielo *	783,00	20	40
 <p>Shui Comfort square washbasin 40 Lavabo Shui Comfort cuadrato 40 \ Lavabo Shui Comfort carré 40 \ Aufsatzbecken quadratisch Shui Comfort 40 \ Раковина квадрат Shui Comfort 60 x 40</p>	40 x 40 x 12,5 h	SHCOLAQ40(X)*	7,95	● Le Acque di Cielo *	655,00	26	52
 <p>Shui Comfort oval washbasin 60 x 38 Lavabo Shui Comfort oval 60 x 38 \ Lavabo Shui Comfort ovale 60 x 38 \ Aufsatzbecken Oval Shui Comfort 60 x 38 \ Раковина овальный Shui Comfort 60 x 38</p>	60 x 38 x 12,5 h	SHCOLAO60(X)*	9,60	● Le Acque di Cielo *	772,00	20	40
 <p>Shui Comfort round washbasin 40 Lavabo Shui Comfort ronda 40 \ Lavabo Shui Comfort tour 40 \ Aufsatzbecken Runde Shui Comfort 40 \ Раковина круглый Shui Comfort 60 x 40</p>	ø40 x 12,5 h	SHCOLAT40(X)*	6,85	● Le Acque di Cielo *	644,00	26	52
 <p>Minimo round washbasin Lavabo Minimo round ronda \ Lavabo Minimo tour Aufsatzbecken Runde Minimo \ Раковина круглый Minimo</p>	ø25 x 11,5 h	MILAT(X)*	3,15	● Le Acque di Cielo *	374,00	152	304
 <p>Minimo square washbasin Lavabo Minimo cuadrato \ Lavabo Minimo carré Aufsatzbecken quadratisch Minimo \ Раковина квадрат Minimo</p>	25 x 25 x 11,5 h	MILAQ(X)*	3,50	● Le Acque di Cielo *	374,00	152	304

* Le Acque di Cielo ● OL - Oltremare ● SM - Smeraldo ● AL - Alga ● CO - Corallo ● NI - Ninfea ● AM - Anemone





Technical symbols legend









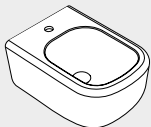

 all sides are enamelled con todos los lados esmaltados \ avec tous les côtés émaillés \ alle Seiten glasiert \ все стороны покрыты эмалью	 no tap holes sin agujero para grifo \ sans orifice robinet ohne Hahnloch без отверстия под смеситель	 without overflow sin rebosadero sans trop-plein ohne Überlauf без слива-перелива	 on top installation instalación de apoyo installation à partir du plan \ Montage auf Platte установка на столешницу
--	--	--	--

Era <small>new</small> CIELO RIMLESS 2.0	Size (cm) Medidas Dimensions Maße Размеры	Product code Artículo Article Artikel Артикул	Net weight (kg) Peso neto Poids net Reingewicht вес нетто	Finishes Acabados Finitions Farbe Отделки	Euro Евро	Pz. pallet Italia	Pz. pallet Cont.
 <p>Wall-hung wc with fixing kit (4,5 LT) - cielo rimless 2.0 Inodoro suspendido completo con fijaciones (4,5 LT) - sin brida - rimless 2.0 \ Cuvette suspendue avec fixations (4,5 LT) - sans bride - rimless 2.0 \ Wand-WC mit BefestigungsKit (4,5 Lt.) - ohne Spülrand - rimless 2.0 \ Подвесной унитаз в комплекте с крепежами (4,5 литр) - без ободка - rimless 2.0</p> <p>53 x 36,5 x 30 h</p> <p>ERVSK(X)*</p> <p>22,60</p> <p> Le Acque di Cielo *</p> <p>698,00</p> <p>18</p> <p>18</p> <p></p>							
 <p>Thermosetting soft close seat & cover Asiento para inodoro amortiguado \ Abattant thermodurcissable soft \ Wc-sitz thermodur mit Abs. \ Сиденье из термоотверждающейся смолы с плавным опусканием</p> <p>CPVERTF(X)*</p> <p> Le Acque di Cielo *</p> <p>273,00</p> <p></p>							
 <p>Impact and acoustic protection panel Protección antigolpes y acústica \ Protection acoustique et anti-choc \ Stoss-und Schalldämmung \ Противоударная и акустическая защита</p> <p>PAA</p> <p>0,16</p> <p>15,00</p>							
 <p>Couple of fixing brackets for wall-hung wc/bidet Pareja de estribo para Inodoro/ Bidet suspendido \ Étriers de fixation pour Wc/Bidet suspendus \ 1 Paar Halterungen für wandhängendes Wc/Bidet \ Монтажная рама для подвесного унитаза/биде</p> <p>508</p> <p>3,30</p> <p>35,00</p>							

* Le Acque di Cielo  OL - Oltremare  SM - Smeraldo  AL - Alga  CO - Corallo  NI - Ninfea  AM - Anemone

Technical symbols legend

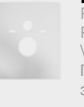





 wall-hung installation instalación suspendida installation suspendue wandhängende Montage подвесная установка	 with fixing parts fijaciones incluidas fixations incluses inklusive Befestigungen \ в комплекте с крепежами	 4,5 l toilet tank descarga 4,5 lt évacuation à 4,5 l 4,5 l-Spülung бак на 4,5 л	 Combifix compatibility compatible Combifix mit Combifix kompatibel совместим с combifix	 quick release hinge sistema extraíble charnières à ouverture mit Überlauf Takeoff Funktion быстрый съём
--	---	--	---	---

Era <small>new</small>	Size (cm) Medidas Dimensions Maße Размеры	Product code Artículo Article Artikel Артикул	Net weight (kg) Peso neto Poids net Reingewicht вес нетто	Finishes Acabados Finitions Farbe Отделки	Euro Евро	Pz. pallet Italia	Pz. pallet Cont.
 <p>Wall-hung one hole bidet with fixing kit Bidé suspendido monoagujero completo con fijaciones / Bidet suspendu monotrou avec fixation / Wand-Bidet einloch mit BefestigungsKit / Биде подвесное с одним отверстием под смеситель, в комплекте с крепежами</p> <p>53 x 36,5 x 30 h</p> <p>ERBS(X)*</p> <p>20,00</p> <p> Le Acque di Cielo *</p> <p>676,00</p> <p>18</p> <p>18</p> <p></p>							
 <p>Universal click/clack drain in CHROME with ceramic lid - Válvula universal click/clack Cromado con tapa en cerámica - Bonde universelle clic/clac Chromé avec clapet en céramique - Universal-Ablaufgarnitur Click-Clack Chrom mit Keramikstopfen - Универсальный донный клапан click/clack хром с керамической крышкой</p> <p>PIL01(X)*</p> <p>0,40</p> <p> Le Acque di Cielo *</p> <p>120,00</p>							
 <p>Universal click/clack drain in MATT BLACK finish with ceramic lid - Válvula universal click/clack Negro Matt con tapa en cerámica - Bonde universelle clic/clac Noir Mat avec clapet en céramique - Universal-Ablaufgarnitur Click-Clack Matt Schwarz mit Keramikstopfen - Универсальный донный клапан click/clack черный матовый с керамической крышкой</p> <p>PIL01NM(X)*</p> <p>0,40</p> <p> Le Acque di Cielo *</p> <p>146,00</p>							
 <p>Universal click/clack drain in CEMENTO finish with ceramic lid - Válvula universal click/clack Cemento con tapa en cerámica - Bonde universelle clic/clac Cemento avec clapet en céramique - Universal-Ablaufgarnitur Click-Clack Cement mit Keramikstopfen - Универсальный донный Cemento click/clack с керамической крышкой</p> <p>PIL01CM(X)*</p> <p>0,40</p> <p> Le Acque di Cielo *</p> <p>146,00</p>							
 <p>Impact and acoustic protection panel Protección antigolpes y acústica \ Protection acoustique et anti-choc \ Stoss-und Schalldämmung \ Противоударная и акустическая защита</p> <p>PAA</p> <p>0,16</p> <p>15,00</p>							
 <p>Couple of fixing brackets for wall-hung wc/bidet Pareja de estribo para Inodoro/ Bidet suspendido \ Étriers de fixation pour Wc/Bidet suspendus \ 1 Paar Halterungen für wandhängendes Wc/Bidet \ Монтажная рама для подвесного унитаза/биде</p> <p>508</p> <p>3,30</p> <p>35,00</p>							

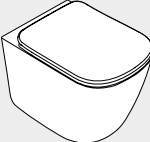
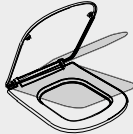
* Le Acque di Cielo  OL - Oltremare  SM - Smeraldo  AL - Alga  CO - Corallo  NI - Ninfea  AM - Anemone





Technical symbols legend







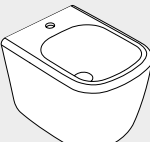

 with overflow con rebosadero avec trop-plein mit Überlauf с переливом	 one tap hole con 1 agujero monotrou 1-Loch \ одно отверстие под смеситель	 wall-hung installation instalación suspendida installation suspendue wandhängende Montage подвесная установка	 with fixing parts fijaciones incluidas fixations incluses inklusive Befestigungen в комплекте с крепежами
--	---	--	--

Era  CIELO RIMLESS 2.0  Wc with horizontal outlet convertible to floor outlet by technical curve (4,5 LT) - cielo rimless 2.0 Wc con desague a pared convertible a suelo con curva técnica (4,5 LT) - sin brida - rimless 2.0 \ Wc avec évacuation murale transformable à terre avec courbe technique (4,5l) - sans bride - rimless 2.0 \ WC mit Wandabfluss, durch Kurventechnik auf Bodenabfluss umrüstbar (4,5 LT) - ohne Spülrand - rimless 2.0 \ Слив в стену при помощи технического колена трансформируется на слив в пол (4,5 л) - без ободка <th data-bbox="526 141 642 771">Size (cm) Medidas Dimensions Maße Размеры <th data-bbox="642 141 777 771">Product code Artículo Article Artikel Артикул <th data-bbox="777 141 906 771">Net weight (kg) Peso neto Poids net Reingewicht вес нетто <th data-bbox="906 141 1157 771">Finishes Acabados Finitions Farbe Отделки <th data-bbox="1157 141 1273 771">Euro Евро <th data-bbox="1273 141 1348 771">Pz. pallet Italia <th data-bbox="1348 141 1420 771">Pz. pallet Cont. </th></th></th></th></th></th></th>	Size (cm) Medidas Dimensions Maße Размеры <th data-bbox="642 141 777 771">Product code Artículo Article Artikel Артикул <th data-bbox="777 141 906 771">Net weight (kg) Peso neto Poids net Reingewicht вес нетто <th data-bbox="906 141 1157 771">Finishes Acabados Finitions Farbe Отделки <th data-bbox="1157 141 1273 771">Euro Евро <th data-bbox="1273 141 1348 771">Pz. pallet Italia <th data-bbox="1348 141 1420 771">Pz. pallet Cont. </th></th></th></th></th></th>	Product code Artículo Article Artikel Артикул <th data-bbox="777 141 906 771">Net weight (kg) Peso neto Poids net Reingewicht вес нетто <th data-bbox="906 141 1157 771">Finishes Acabados Finitions Farbe Отделки <th data-bbox="1157 141 1273 771">Euro Евро <th data-bbox="1273 141 1348 771">Pz. pallet Italia <th data-bbox="1348 141 1420 771">Pz. pallet Cont. </th></th></th></th></th>	Net weight (kg) Peso neto Poids net Reingewicht вес нетто <th data-bbox="906 141 1157 771">Finishes Acabados Finitions Farbe Отделки <th data-bbox="1157 141 1273 771">Euro Евро <th data-bbox="1273 141 1348 771">Pz. pallet Italia <th data-bbox="1348 141 1420 771">Pz. pallet Cont. </th></th></th></th>	Finishes Acabados Finitions Farbe Отделки <th data-bbox="1157 141 1273 771">Euro Евро <th data-bbox="1273 141 1348 771">Pz. pallet Italia <th data-bbox="1348 141 1420 771">Pz. pallet Cont. </th></th></th>	Euro Евро <th data-bbox="1273 141 1348 771">Pz. pallet Italia <th data-bbox="1348 141 1420 771">Pz. pallet Cont. </th></th>	Pz. pallet Italia <th data-bbox="1348 141 1420 771">Pz. pallet Cont. </th>	Pz. pallet Cont.
 Thermosetting soft close seat & cover Asiento para inodoro amortiguado \ Abattant thermodurcissable soft \ Wc-sitz thermodur mit Abs. \ Сиденье из термоотверждающейся смолы с плавным опусканием	52 x 36,5 x 42 h	ERVAK(x)*	29,20	 Le Acque di Cielo *	698,00	15	20
 Technical curve "floor trap" for toilet Curva técnica "salida vertical" para inodoro \ Courbe technique à S pour cuvette avec sortie au sol \ WC-Ablaufbogen "S" \ Колено "S"-образное для унитазов, регулируемое		CPVERTF(x)*		 Le Acque di Cielo *	273,00		
 Straight pan connector for wall trap Anclaje a pared para inodoro \ Pipe pour sortie horizontale \ WC-Anschlussstutzen für Abgang \ waagerecht \ Фитинг для выпуска в стену для унитазов		CSB	0,40		16,00		
 Technical curve "floor trap" for toilet Curva técnica "salida vertical" para inodoro \ Courbe technique à S pour cuvette avec sortie au sol \ WC-Ablaufbogen "S" \ Колено "S"-образное для унитазов, регулируемое		RPB	0,35		13,00		

* Le Acque di Cielo  OL - Oltremare  SM - Smeraldo  AL - Alga  CO - Corallo  NI - Ninfea  AM - Anemone





Technical symbols legend

 back to wall installation instalación a suelo installation à terre bodenstehende Montage напольная установка	 with fixing parts fijaciones incluidas fixations incluses inklusive Befestigung- gen \ в комплекте с крепежами	 4,5 l toilet tank descarga 4,5 l évacuation à 4,5 l 4,5 l-Spülung бачок на 4,5 л	 bifunctional drain descarga bifuncional évacuation bifonction- nelle \ Spülung mit zwei Montagevarianten функциональный бачок	 quick release hinge sistema extráctil charnières à ouverture Takeoff Funktion быстрый съем
---	--	---	---	---

Era   Back to wall one hole bidet Bidé a suelo monoagujero Bidet monotrou Stand-Bidet einloch Биде напольное с одним отверстием под смеситель <th data-bbox="2094 141 2210 771">Size (cm) Medidas Dimensions Maße Размеры <th data-bbox="2210 141 2345 771">Product code Artículo Article Artikel Артикул <th data-bbox="2345 141 2474 771">Net weight (kg) Peso neto Poids net Reingewicht вес нетто <th data-bbox="2474 141 2725 771">Finishes Acabados Finitions Farbe Отделки <th data-bbox="2725 141 2841 771">Euro Евро <th data-bbox="2841 141 2916 771">Pz. pallet Italia <th data-bbox="2916 141 2988 771">Pz. pallet Cont. </th></th></th></th></th></th></th>	Size (cm) Medidas Dimensions Maße Размеры <th data-bbox="2210 141 2345 771">Product code Artículo Article Artikel Артикул <th data-bbox="2345 141 2474 771">Net weight (kg) Peso neto Poids net Reingewicht вес нетто <th data-bbox="2474 141 2725 771">Finishes Acabados Finitions Farbe Отделки <th data-bbox="2725 141 2841 771">Euro Евро <th data-bbox="2841 141 2916 771">Pz. pallet Italia <th data-bbox="2916 141 2988 771">Pz. pallet Cont. </th></th></th></th></th></th>	Product code Artículo Article Artikel Артикул <th data-bbox="2345 141 2474 771">Net weight (kg) Peso neto Poids net Reingewicht вес нетто <th data-bbox="2474 141 2725 771">Finishes Acabados Finitions Farbe Отделки <th data-bbox="2725 141 2841 771">Euro Евро <th data-bbox="2841 141 2916 771">Pz. pallet Italia <th data-bbox="2916 141 2988 771">Pz. pallet Cont. </th></th></th></th></th>	Net weight (kg) Peso neto Poids net Reingewicht вес нетто <th data-bbox="2474 141 2725 771">Finishes Acabados Finitions Farbe Отделки <th data-bbox="2725 141 2841 771">Euro Евро <th data-bbox="2841 141 2916 771">Pz. pallet Italia <th data-bbox="2916 141 2988 771">Pz. pallet Cont. </th></th></th></th>	Finishes Acabados Finitions Farbe Отделки <th data-bbox="2725 141 2841 771">Euro Евро <th data-bbox="2841 141 2916 771">Pz. pallet Italia <th data-bbox="2916 141 2988 771">Pz. pallet Cont. </th></th></th>	Euro Евро <th data-bbox="2841 141 2916 771">Pz. pallet Italia <th data-bbox="2916 141 2988 771">Pz. pallet Cont. </th></th>	Pz. pallet Italia <th data-bbox="2916 141 2988 771">Pz. pallet Cont. </th>	Pz. pallet Cont.
 Universal click-clack drain in CHROME with ceramic lid Válvula universal click-clack Cromado con tapa en cerámica \ Bonde universelle clic-clac Chromé avec clapet en céramique \ Universal-Ablaufgarnitur Click-Clack Chrom mit Keramikstopfen \ Универсальный донный клапан click/clack хром с керамической крышкой	52 x 36,5 x 42 h	ERBI(x)*	26,00	 Le Acque di Cielo *	671,00	15	20
 Universal click-clack drain in MATT BLACK finish with ceramic lid Válvula universal click-clack Negro Matt con tapa en cerámica \ Bonde universelle clic-clac Noir Mat avec clapet en céramique \ Universal-Ablaufgarnitur Click-Clack Matt Schwarz mit Keramikstopfen \ Универсальный донный клапан click/clack черный матовый с керамической крышкой		PIL01(x)*	0,40	 Le Acque di Cielo *	120,00		
 Universal click-clack drain in MATT BLACK finish with ceramic lid Válvula universal click-clack Negro Matt con tapa en cerámica \ Bonde universelle clic-clac Noir Mat avec clapet en céramique \ Universal-Ablaufgarnitur Click-Clack Matt Schwarz mit Keramikstopfen \ Универсальный донный клапан click/clack черный матовый с керамической крышкой		PIL01NM(x)*	0,40	 Le Acque di Cielo *	146,00		
 Universal click-clack drain in CEMENTO finish with ceramic lid Válvula universal click-clack Cemento con tapa en cerámica \ Bonde universelle clic-clac Cemento avec clapet en céramique \ Universal-Ablaufgarnitur Click-Clack Cement mit Keramikstopfen \ Универсальный донный клапан click/clack с керамической крышкой		PIL01CM(x)*	0,40	 Le Acque di Cielo *	146,00		

* Le Acque di Cielo  OL - Oltremare  SM - Smeraldo  AL - Alga  CO - Corallo  NI - Ninfea  AM - Anemone





Technical symbols legend







 one tap hole con 1 agujero monotrou 1-Loch одно отверстие под смеситель	 with overflow con rsbosadero avec trop-plein mit Überlauf с переливом	 back to wall installation instalación a suelo installation à terre bodenstehende Montage напольная установка	 with fixing parts fijaciones inclusas fixations incluses inklusive Befestigung- gen \ в комплекте с крепежами
---	--	---	---

Smile 53 wc wall-hung	Size (cm) Medidas Dimensions Maße Размеры	Product code Artículo Article Artikel Артикул	Net weight (kg) Peso neto Poids net Reingewicht вес нетто	Finishes Acabados Finitions Farbe Отделка	Euro Евро	Pz. pallet Italia	Pz. pallet Cont.
 <p>NEW wall-hung wc with hidden fixing system (4,5Lt) Wc suspendido NEW completo con fijaciones (4,5 Lt) \ Wc suspendu NEW avec fixations cachées (4,5 lt) \ Wand-WC NEW mit Einbauhalterungen (4,5 l) \ Унитаз подвесной NEW в комплекте со скрытыми крепежами (4,5 л)</p> <p>⊞ ⊞ ⊞ ⊞</p>	53 x 35 x 27 h	SMVSNW(X)*	21,35	 Le Acque di Cielo *	660,00	18	18
 <p>Thermosetting contoured wrap lid soft close seat & cover Asiento para inodoro amortiguado \ Abattant thermodurcissable soft \ Wc-sitz thermotur mit Abs. \ Сиденье из термоотверждающейся смолы, с плавным опусканием</p> <p>⊞</p>		CPVSMF(X)*	3,00	 Le Acque di Cielo *	273,00		
 <p>Thermosetting slim double flap soft close seat & cover with quick release hinges Asiento para inodoro amortiguado bisagra con sistema extraíble \ Abattant thermodurcissable soft avec charnières à ouverture \ Wc sitz in thermotur mit soft-closet und Takeoff Funktion \ Сиденье съемное из термоотверждающейся смолы с плавным опусканием</p> <p>⊞</p>		CPVSMNEWF(X)*	2,30	 Le Acque di Cielo *	273,00		
 <p>Impact and acoustic protection panel Protección antigolpes y acústica \ Protection acoustique et anti-choc \ Stoss-und Schalldämmung \ Противоударная и акустическая защита</p>		PAA	0,16		15,00		
 <p>Couple of fixing brackets for wall-hung wc/bidet Pareja de estribo para Inodoro/ Bidet suspendido \ Étriers de fixation pour Wc/Bidet suspendus \ 1 Paar Halterungen für wandhängendes Wc/Bidet \ Монтажная рама для подвесного унитаза/биде</p>		508	3,30		35,00		

* Le Acque di Cielo  OL - Oltremare  SM - Smeraldo  AL - Alga  CO - Corallo  NI - Ninfea  AM - Anemone

Technical symbols legend





 wall-hung installation instalación suspendida installation suspendue wandhängende Montage подвесная установка	 with fixing parts fijaciones incluidas fixations incluses inklusive Befestigung- gen \ в комплекте с крепежами	 4,5 l toilet tank descarga 4,5 l évacuation à 4,5 l 4,5 l-Spülung бачок на 4,5 л	 Combifix compatibility compatible Combifix mit Combifix kompatibel совместим с combifix	 quick release hinge sistema extraíble charnières à ouverture Takeoff Funktion быстрый съем
---	---	--	--	--

Smile 53 wc wall-hung - rimless	Size (cm) Medidas Dimensions Maße Размеры	Product code Artículo Article Artikel Артикул	Net weight (kg) Peso neto Poids net Reingewicht вес нетто	Finishes Acabados Finitions Farbe Отделка	Euro Евро	Pz. pallet Italia	Pz. pallet Cont.
 <p>Wall-hung wc with hidden fixing system (4,5Lt) - rimless Wc suspendido completo con fijaciones (4,5 Lt) - sin brida \ Wc suspendu avec fixations (4,5 Lt) - sans bride \ Wand-WC mit Befestigungskit (4,5 lt.) - ohne Spülrand \ Подвесной унитаз в комплекте с крепежами (4,5 литр) - без ободка</p> <p>⊞ ⊞ ⊞ ⊞ ⊞</p>	53 x 35 x 27 h	SMVSNW(X)*	20,30	 Le Acque di Cielo *	660,00	18	18
 <p>Thermosetting contoured wrap lid soft close seat & cover Asiento para inodoro amortiguado \ Abattant thermodurcissable soft \ Wc-sitz thermotur mit Abs. \ Сиденье из термоотверждающейся смолы, с плавным опусканием</p> <p>⊞</p>		CPVSMF(X)*	3,00	 Le Acque di Cielo *	273,00		
 <p>Thermosetting slim double flap soft close seat & cover with quick release hinges Asiento para inodoro amortiguado bisagra con sistema extraíble \ Abattant thermodurcissable soft avec charnières à ouverture \ Wc sitz in thermotur mit soft-closet und Takeoff Funktion \ Сиденье съемное из термоотверждающейся смолы с плавным опусканием</p> <p>⊞</p>		CPVSMNEWF(X)*	2,30	 Le Acque di Cielo *	273,00		
 <p>Impact and acoustic protection panel Protección antigolpes y acústica \ Protection acoustique et anti-choc \ Stoss-und Schalldämmung \ Противоударная и акустическая защита</p>		PAA	0,16		15,00		
 <p>Couple of fixing brackets for wall-hung wc/bidet Pareja de estribo para Inodoro/ Bidet suspendido \ Étriers de fixation pour Wc/Bidet suspendus \ 1 Paar Halterungen für wandhängendes Wc/Bidet \ Монтажная рама для подвесного унитаза/биде</p>		508	3,30		35,00		

* Le Acque di Cielo  OL - Oltremare  SM - Smeraldo  AL - Alga  CO - Corallo  NI - Ninfea  AM - Anemone

Technical symbols legend





 wall-hung installation instalación suspendida installation suspendue wandhängende Montage подвесная установка	 with fixing parts fijaciones incluidas fixations incluses inklusive Befestigung- gen \ в комплекте с крепежами	 4,5 l toilet tank descarga 4,5 l évacuation à 4,5 l 4,5 l-Spülung бачок на 4,5 л	 Combifix compatibility compatible Combifix mit Combifix kompatibel совместим с combifix	 quick release hinge sistema extraíble charnières à ouverture Takeoff Funktion быстрый съем	 rimless sin brida sans bride ohne Spülrand без ободка
---	---	--	--	--	---

Smile 53 bidet wall-hung	Size (cm) Medidas Dimensions Maße Размеры	Product code Artículo Article Artikel Артикул	Net weight (kg) Peso neto Poids net Reingewicht вес нетто	Finishes Acabados Finitions Farbe Отделки	Euro Евро	Pz. pallet Italia	Pz. pallet Cont.
 NEW wall-hung one hole bidet with hidden fixing system Bidé monoagujero suspendido NEW completo con fijaciones \ idet suspendu NEW monotrou avec fixations cachées Wand-Bidet NEW, Einlocharmatur, mit Halterungen \ Биде подвесное NEW с одним отверстием под смеситель, в комплекте со скрытыми крепежами 	53 x 35 x 27 h	SMBSNW(X)*	16,10	 Le Acque di Cielo *	660,00	18	18
 Universal click/clack drain in CHROME with ceramic lid - Válvula universal click/clack Cromado con tapa en cerámica - Bonde universelle clic/clac Chromé avec clapet en céramique - Universal-Ablaufgarnitur Click-Clack Chrom mit Keramikstopfen - Универсальный донный клапан click/clack хром с керамической крышкой		PIL01(X)*	0,40	 Le Acque di Cielo *	120,00		
 Universal click/clack drain in MATT BLACK finish with ceramic lid - Válvula universal click/clack Negro Matt con tapa en cerámica - Bonde universelle clic/clac Noir Mat avec clapet en céramique - Universal-Ablaufgarnitur Click-Clack Matt Schwarz mit Keramikstopfen - Универсальный донный клапан click/clack черный матовый с керамической крышкой		PIL01NM(X)*	0,40	 Le Acque di Cielo *	146,00		
 Universal click/clack drain in CEMENTO finish with ceramic lid - Válvula universal click/clack Cemento con tapa en cerámica - Bonde universelle clic/clac Cemento avec clapet en céramique - Universal-Ablaufgarnitur Click-Clack Cement mit Keramikstopfen - Универсальный донный клапан click/clack с керамической крышкой		PIL01CM(X)*	0,40	 Le Acque di Cielo *	146,00		
 Impact and acoustic protection panel Protección antigolpes y acústica \ Protection acoustique et anti-choc \ Stoss-und Schalldämmung \ Противоударная и акустическая защита		PAA	0,16		15,00		
 Couple of fixing brackets for wall-hung wc/bidet Pareja de estribo para Inodoro/ Bidet suspendido \ Étriers de fixation pour Wc/Bidet suspendus \ 1 Paar Halterungen für wandhängendes Wc/Bidet Монтажная рама для подвесного унитаза/биде		508	3,30		35,00		

* Le Acque di Cielo  OL - Oltremare  SM - Smeraldo  AL - Alga  CO - Corallo  NI - Ninfea  AM - Anemone

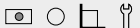
Technical symbols legend











 with overflow con rebosadero avec trop-plein mit Überlauf с переливом	 one tap hole con 1 agujero monotrou 1-Loch \ одно отверстие под смеситель	 wall-hung installation instalación suspendida installation suspendue wandhängende Montage подвесная установка	 with fixing parts fijaciones incluidas fixations incluses inklusive Befestigungen в комплекте с крепежами
--	---	--	--

Smile 53 bidet back to wall	Size (cm) Medidas Dimensions Maße Размеры	Product code Artículo Article Artikel Артикул	Net weight (kg) Peso neto Poids net Reingewicht вес нетто	Finishes Acabados Finitions Farbe Отделки	Euro Евро	Pz. pallet Italia	Pz. pallet Cont.
 Back to wall one hole bidet Bidé a suelo monoagujero Bidet monotrou Stand-Bidet einloch Биде напольное с одним отверстием под смеситель 	53 x 35 x 42 h	SMBID(X)*	23,15	 Le Acque di Cielo *	648,00	15	20
 Universal click-clack drain in CHROME with ceramic lid Válvula universal click-clack Cromado con tapa en cerámica \ Bonde universelle clic-clac Chromé avec clapet en céramique \ Universal-Ablaufgarnitur Click-Clack Chrom mit Keramikstopfen \ Универсальный донный клапан click/clack хром с керамической крышкой		PIL01(X)*	0,40	 Le Acque di Cielo *	120,00		
 Universal click-clack drain in MATT BLACK finish with ceramic lid Válvula universal click-clack Negro Matt con tapa en cerámica \ Bonde universelle clic-clac Noir Mat avec clapet en céramique \ Universal-Ablaufgarnitur Click-Clack Matt Schwarz mit Keramikstopfen \ Универсальный донный клапан click/clack черный матовый с керамической крышкой		PIL01NM(X)*	0,40	 Le Acque di Cielo *	146,00		
 Universal click-clack drain in CEMENTO finish with ceramic lid Válvula universal click-clack Cemento con tapa en cerámica \ Bonde universelle clic-clac Cemento avec clapet en céramique \ Universal-Ablaufgarnitur Click-Clack Cement mit Keramikstopfen \ Универсальный донный клапан click/clack с керамической крышкой		PIL01CM(X)*	0,40	 Le Acque di Cielo *	146,00		

* Le Acque di Cielo  OL - Oltremare  SM - Smeraldo  AL - Alga  CO - Corallo  NI - Ninfea  AM - Anemone







Technical symbols legend







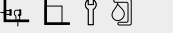

 one tap hole con 1 agujero monotrou 1-Loch одно отверстие под смеситель	 with overflow con rebosadero avec trop-plein mit Überlauf с переливом	 back to wall installation instalación a suelo installation à terre bodenstehende Montage напольная установка	 with fixing parts fijaciones incluidas fixations incluses inklusive Befestigungen в комплекте с крепежами
---	--	---	--

Smile 53 wc back to wall - rimless	Size (cm) Medidas Dimensions Maße Размеры	Product code Artículo Article Artikel Артикул	Net weight(kg) Peso neto Poids net Reingewicht вес нетто	Finishes Acabados Finitions Farbe Отделки	Euro Евро	Pz. pallet Italia	Pz. pallet Cont.
 <p>Wc with horizontal outlet convertible to floor outlet by technical curve (4,5 LT) - rimless Wc con desagüe a pared convertible a suelo con curva técnica (4,5 LT) - sin brida \ Wc avec évacuation murale transformable à terre avec courbe technique (4,5l) - sans bride \ WC mit Wandabfluss, durch Kurventechnik auf \ Bodenabfluss umrüstbar (4,5 LT) - ohne Spülrand \ Слив в стену при помощи технического колена трансформируется на слив в пол (4,5 л) - без ободка</p> 	53 x 35 x 42 h	SMVASK(X)*	28,90	 Le Acque di Cielo *	670,00	15	20
 <p>Thermosetting contoured wrap lid soft close seat & cover Asiento para inodoro amortiguado \ Abattant thermodurcissable soft \ Wc-sitz thermotur mit Abs. \ Сиденье из термоотверждающейся смолы, с плавным опусканием</p> 		CPVSMF(X)*	3,00	 Le Acque di Cielo *	273,00		
 <p>Thermosetting slim double flap soft close seat & cover with quick release hinges Asiento para inodoro amortiguado bisagra con sistema extraíble \ Abattant thermodurcissable soft avec charnières à ouverture \ Wc sitz in thermotur mit soft-closet und Takeoff Funktion \ Сиденье съемное из термоотверждающейся смолы с плавным опусканием</p> 		CPVSMNEWF(X)*	2,30	 Le Acque di Cielo *	273,00		
 <p>Technical curve "floor trap" for toilet Curva técnica "salida vertical" para inodoro \ Courbe technique à S pour cuvette avec sortie au sol \ WC-Ablaufbogen "S" \ Колено "S"-образное для унитазов, регулируемое</p>		CSB	0,40		16,00		
 <p>Straight pan connector for wall trap Anclaje a pared para inodoro \ Pipe pour sortie horizontale \ WC-Anschlussstutzen für Abgang waagerecht \ Фитинг для выпуска в стену для унитазов</p>		RPB	0,35		13,00		

* Le Acque di Cielo  OL - Oltremare  SM - Smeraldo  AL - Alga  CO - Corallo  NI - Ninfea  AM - Anemone





Technical symbols legend







 back to wall installation instalación a suelo installation à terre bodenstehende Montage напольная установка	 with fixing parts fijaciones incluidas fixations incluses inklusive Befestigung- en \ в комплекте с крепежами	 4,5 l toilet tank descarga 4,5 lt évacuation à 4,5 l 4,5 l-Spülung бачок на 4,5 л	 bifunctional drain descarga bifuncional évacuation bifonction- nelle \ Spülung mit zwei Montagevarianten функциональный бачок	 quick release hinge sistema extraíble charnières à ouverture Takeoff Funktion быстрый съем	 rimless sin brida sans bride ohne Spülrand без ободка
--	--	---	--	--	---

Smile 53 wc back to wall	Size (cm) Medidas Dimensions Maße Размеры	Product code Artículo Article Artikel Артикул	Net weight(kg) Peso neto Poids net Reingewicht вес нетто	Finishes Acabados Finitions Farbe Отделки	Euro Евро	Pz. pallet Italia	Pz. pallet Cont.
 <p>Wc with horizontal outlet convertible to floor outlet by technical curve (4,5 LT) Wc con desagüe a pared convertible a suelo con curva técnica (4,5 LT) \ Wc avec évacuation murale transformable à terre avec courbe technique (4,5l) \ WC mit Wandabfluss, durch Kurventechnik auf Bodenabfluss umrüstbar (4,5 LT) \ Слив в стену при помощи технического колена трансформируется на слив в пол (4,5 л)</p> 	53 x 35 x 42 h	SMVAS(X)*	28,90	 Le Acque di Cielo *	648,00	15	20
 <p>Thermosetting contoured wrap lid soft close seat & cover Asiento para inodoro amortiguado \ Abattant thermodurcissable soft \ Wc-sitz thermotur mit Abs. \ Сиденье из термоотверждающейся смолы, с плавным опусканием</p> 		CPVSMF(X)*	3,00	 Le Acque di Cielo *	273,00		
 <p>Thermosetting slim double flap soft close seat & cover with quick release hinges Asiento para inodoro amortiguado bisagra con sistema extraíble \ Abattant thermodurcissable soft avec charnières à ouverture \ Wc sitz in thermotur mit soft-closet und Takeoff Funktion \ Сиденье съемное из термоотверждающейся смолы с плавным опусканием</p> 		CPVSMNEWF(X)*	2,30	 Le Acque di Cielo *	273,00		
 <p>Technical curve "floor trap" for toilet Curva técnica "salida vertical" para inodoro \ Courbe technique à S pour cuvette avec sortie au sol \ WC-Ablaufbogen "S" \ Колено "S"-образное для унитазов, регулируемое</p>		CSB	0,40		16,00		
 <p>Straight pan connector for wall trap Anclaje a pared para inodoro \ Pipe pour sortie horizontale \ WC-Anschlussstutzen für Abgang waagerecht \ Фитинг для выпуска в стену для унитазов</p>		RPB	0,35		13,00		

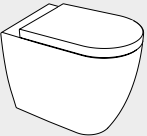
* Le Acque di Cielo  OL - Oltremare  SM - Smeraldo  AL - Alga  CO - Corallo  NI - Ninfea  AM - Anemone





Technical symbols legend





 back to wall installation instalación a suelo installation à terre bodenstehende Montage напольная установка	 with fixing parts fijaciones incluidas fixations incluses inklusive Befestigung- en \ в комплекте с крепежами	 4,5 l toilet tank descarga 4,5 lt évacuation à 4,5 l 4,5 l-Spülung бачок на 4,5 л	 bifunctional drain descarga bifuncional évacuation bifonction- nelle \ Spülung mit zwei Montagevarianten функциональный бачок	 quick release hinge sistema extraíble charnières à ouverture Takeoff Funktion быстрый съем
--	--	---	--	--









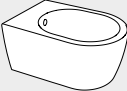

 <p>Smile 53 wc adjustable water inlet/outlet</p> <p>Back-to-wall WC with adjustable water inlet/outlet (4,5 LT) Inodoro a suelo bifuncional con salida a distancia especial (4,5 LT) \ Vase au sol bifonctionnel avec raccord de la décharge allongé (4,5 LT) \ Bodenstehendes WC (bifunktional mit einstellbaren Ablauf) (4,5 Lt) \ Бифункциональный напольный унитаз с адаптируемым выпуском</p>	<p>Size (cm) Medidas Dimensions Maße Размеры</p> <p>54 x 35 x 42 h</p>	<p>Product code Artículo Article Artikel Артикул</p> <p>SMVASTR(X)*</p>	<p>Net weight (kg) Peso neto Poids net Reingewicht вес нетто</p> <p>28,85</p>	<p>Finishes Acabados Finitions Farbe Отделки</p> <p> Le Acque di Cielo *</p>	<p>Euro Евро</p> <p>648,00</p>	<p>Pz. pallet Italia</p> <p>15</p>	<p>Pz. pallet Cont.</p> <p>20</p>
 <p>Thermosetting contoured wrap lid soft close seat & cover Asiento para inodoro amortiguado \ Abattant thermodurcissable soft \ Wc-sitz thermodur mit Abs. \ Сиденье из термоотверждающейся смолы, с плавным опусканием</p>		<p>CPVSMF(X)*</p>	<p>3,00</p>	<p> Le Acque di Cielo *</p>	<p>273,00</p>		
 <p>Thermosetting slim double flap soft close seat & cover with quick release hinges Asiento para inodoro amortiguado bisagra con sistema extraíble \ Abattant thermodurcissable soft avec charnières à ouverture \ Wc sitz in thermodur mit soft-closet und Takeoff Funktion \ Сиденье съемное из термоотверждающейся смолы с плавным опусканием</p>		<p>CPVSMNEW(X)*</p>	<p>2,30</p>	<p> Le Acque di Cielo *</p>	<p>273,00</p>		

* Le Acque di Cielo      

Technical symbols legend

 back to wall installation Instalación a suelo Installation à terre bodenstehende Montage напольная установка	 with fixing parts Fijaciones incluidas fixations incluses inklusive Befestigung в комплекте с крепежами	 4,5 l toilet tank descarga 4,5 l évacuation à 4,5 l 4,5 l-Spülung бачок на 4,5 л	 bifunctional drain descarga bifuncional évacuation bifonctionnelle \ Spülung mit zwei Montagevarianten функциональный бачок	 quick release hinge sistema extraíble charnières à ouverture Takeoff Funktion быстрый съем
---	--	---	--	---



<p>Technical curves</p>	<p>Product code Artículo Article Artikel Артикул</p>	<p>Net weight (kg) Peso neto Poids net Reingewicht вес нетто</p>	<p>Finishes Acabados Finitions Farbe Отделки</p>	<p>Euro Евро</p>	<p>Pz. pallet Italia</p>	<p>Pz. pallet Cont.</p>
 <p>Technical curve "floor trap" for toilet Curva técnica "salida vertical" para inodoro \ Courbe technique à S pour cuvette avec sortie au sol \ WC-Ablaufbogen "S" \ Колено "S"-образное для унитазов, регулируемое</p>	<p>CSB</p>	<p>0,40</p>		<p>16,00</p>		
 <p>90° technical curve. Curva de técnica a noventa grados. Pipe d'évacuation à 90°. WC-Aublaufbogen 90 Grad. Колено 90° регулируемое .</p>	<p>CSR90</p>	<p>0,75</p>		<p>17,00</p>		
 <p>PVC pipe for adjustable water outlet WC. Curva técnica para inodoro con salida a distancia especial. \ Courbe technique pour vase avec raccord décharge. \ Technischer Bogen zum WC mit einstellbaren Ablauf. \ Колено для унитаза со сливом в пол.</p>	<p>CSTR</p>	<p>0,75</p>		<p>37,00</p>		
 <p>Straight pan connector for wall trap Anclaje a pared para inodoro \ Pipe pour sortie horizontale \ WC-Anschlussstutzen für Abgang waagerecht \ Фитинг для выпуска в стену для унитазов</p>	<p>RPB</p>	<p>0,35</p>		<p>13,00</p>		
 <p>Eccentric pipe for water outlet up to ± 1,5 cm. Tubo buque trasero excéntrico máximo ± 1,5 cm. \ Pipe de raccordement d'évacuation WC excentré max ± 1,50 cm. \ WC-Abgangstutzen mit Excenter (max ± 1,5 cm). \ Патрубок для унитаза эксцентрический макс. ± 1,5 cm.</p>	<p>RSE</p>	<p>0,10</p>		<p>13,00</p>		

Smile 48 bidet wall-hung	Size (cm) Medidas Dimensions Maße Размеры	Product code Artículo Article Artikel Артикул	Net weight (kg) Peso neto Poids net Reingewicht вес нетто	Finishes Acabados Finitions Farbe Отделки	Euro Евро	Pz. pallet Italia	Pz. pallet Cont.
 MINI wall-hung one hole bidet with hidden fixing system Bidé monoagujero suspendido MINI completo con fijaciones \ Bidet suspendu MINI monotrou avec fixations cachées \ Wand-Bidet MINI, Einlocharmatur, mit Halterungen Биде подвесное MINI с одним отверстием под смеситель, в комплекте со скрытыми крепежами ☑ ○ □ ⚙	48 x 35 x 26 h	SMBSR(X)*	13,70	 Le Acque di Cielo *	590,00	18	18
 Universal click/clack drain in CHROME with ceramic lid - Válvula universal click/clack Cromado con tapa en cerámica - Bonde universelle clic/clac Chromé avec clapet en céramique - Universal-Ablaufgarnitur Click-Clack Chrom mit Keramikstopfen - Универсальный донный клапан click/clack хром с керамической крышкой		PIL01(X)*	0,40	 Le Acque di Cielo *	120,00		
 Universal click/clack drain in MATT BLACK finish with ceramic lid - Válvula universal click/clack Negro Matt con tapa en cerámica - Bonde universelle clic/clac Noir Mat avec clapet en céramique - Universal-Ablaufgarnitur Click-Clack Matt Schwarz mit Keramikstopfen - Универсальный донный клапан click/clack черный матовый с керамической крышкой		PIL01NM(X)*	0,40	 Le Acque di Cielo *	146,00		
 Universal click/clack drain in CEMENTO finish with ceramic lid - Válvula universal click/clack Cemento con tapa en cerámica - Bonde universelle clic/clac Cemento avec clapet en céramique - Universal-Ablaufgarnitur Click-Clack Cement mit Keramikstopfen - Универсальный донный Cemento click/clack с керамической крышкой		PIL01CM(X)*	0,40	 Le Acque di Cielo *	146,00		
 Impact and acoustic protection panel Protección antigolpes y acústica \ Protection acoustique et anti-choc \ Stoss-und Schalldämmung \ Противоударная и акустическая защита		PAA	0,16		15,00		
 Couple of fixing brackets for wall-hung wc/bidet Pareja de estribo para Inodoro/Bidet suspendido \ Étriers de fixation pour Wc/ Bidet suspendus \ 1 Paar Halterungen für wandhängendes Wc/Bidet \ Монтажная рама для подвесного унитаза/биде		508	3,30		35,00		

* Le Acque di Cielo  OL - Oltremare  SM - Smeraldo  AL - Alga  CO - Corallo  NI - Ninfea  AM - Anemone



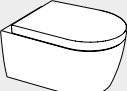

Technical symbols legend

 with overflow con rebosadero avec trop-plein mit Überlauf с переливом	 one tap hole con 1 agujero monotrou 1-Loch \ одно отверстие под смеситель	 wall-hung installation instalación suspendida installation suspendue wandhängende Montage подвесная установка	 with fixing parts fijaciones incluidas fixations incluses inklusive Befestigungen в комплекте с крепежами
---	--	---	---

Smile 48 wc wall-hung	Size (cm) Medidas Dimensions Maße Размеры	Product code Artículo Article Artikel Артикул	Net weight (kg) Peso neto Poids net Reingewicht вес нетто	Finishes Acabados Finitions Farbe Отделки	Euro Евро	Pz. pallet Italia	Pz. pallet Cont.
 MINI wall-hung wc with hidden fixing system (4,5Lt) Wc suspendido MINI completo con fijaciones (4,5 LT) \ Wc suspendu MINI avec fixations cachées (4,5 lt) \ Wand-WC MINI mit Einbauhalterungen (4,5 l) \ Унитаз подвесной MINI в комплекте со скрытыми крепежами (4,5 л) □ ⚙ C ⚙	48 x 35 x 26 h	SMVSR(X)*	20,50	 Le Acque di Cielo *	590,00	18	18
 Thermosetting contoured wrap lid soft close seat & cover Asiento para inodoro amortiguado \ Abattant thermodurcissable soft \ Wc-sitz thermodur mit Abs. \ Сиденье из термоотверждающейся смолы, с плавным опусканием		CPVSMF(X)*	3,00	 Le Acque di Cielo *	273,00		
 Thermosetting slim double flap soft close seat & cover with quick release hinges Asiento para inodoro amortiguado bisagra con sistema extraíble \ Abattant thermodurcissable soft avec charnières à ouverture \ Wc sitz in thermodur mit soft-closet und Takeoff Funktion \ Сиденье съемное из термоотверждающейся смолы с плавным опусканием		CPVSMNEWF(X)*	2,30	 Le Acque di Cielo *	273,00		
 Impact and acoustic protection panel Protección antigolpes y acústica \ Protection acoustique et anti-choc \ Stoss-und Schalldämmung \ Противоударная и акустическая защита		PAA	0,16		15,00		
 Couple of fixing brackets for wall-hung wc/bidet Pareja de estribo para Inodoro/Bidet suspendido \ Étriers de fixation pour Wc/ Bidet suspendus \ 1 Paar Halterungen für wandhängendes Wc/Bidet \ Монтажная рама для подвесного унитаза/биде		508	3,30		35,00		

* Le Acque di Cielo  OL - Oltremare  SM - Smeraldo  AL - Alga  CO - Corallo  NI - Ninfea  AM - Anemone

Technical symbols legend







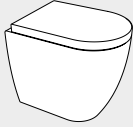

 wall-hung installation instalación suspendida installation suspendue wandhängende Montage подвесная установка	 with fixing parts fijaciones incluidas fixations incluses inklusive Befestigungen в комплекте с крепежами	 4,5 l toilet tank descarga 4,5 lt évacuation à 4,5 l 4,5 l-Spülung бачок на 4,5 л	 Combifix compatibility compatible Combifix mit Combifix kompatibel совместим с combifix	 quick release hinge sistema extralib charnières à ouverture Takeoff Funktion быстрый съем
---	---	---	--	---

Smile 48 wc wall-hung - rimless 	Size (cm) Medidas Dimensions Maße Размеры	Product code Artículo Article Artikel Артикул	Net weight (kg) Peso neto Poids net Reingewicht вес нетто	Finishes Acabados Finitions Farbe Отделки	Euro Евро	Pz. pallet Italia	Pz. pallet Cont.
Wall-hung MINI wc with hidden fixing system (4,5Lt) - rimless Wc suspendido completo con fijaciones (4,5 LT) - sin brida \ Wc suspendu avec fixations (4,5 LT) - sans bride \ Wand-WC mit Befestigungskit (4,5 Lt.) - ohne Spülrand \ Подвесной унитаз в комплекте с крепежами (4,5 литр) - без ободка 	48 x 35 x 26 h	SMVSRK(X)*	19,00	 Le Acque di Cielo *	600,00	18	18
 Thermosetting contoured wrap lid soft close seat & cover Asiento para inodoro amortiguado \ Abattant thermodurcissable soft \ Wc-sitz thermodur mit Abs. \ Сиденье из термоотверждающейся смолы, с плавным опусканием 		CPVSMF(X)*	3,00	 Le Acque di Cielo *	273,00		
 Thermosetting slim double flap soft close seat & cover with quick release hinges Asiento para inodoro amortiguado bisagra con sistema extraíble \ Abattant thermodurcissable soft avec charnières à ouverture \ Wc sitz in thermodur mit soft-closet und Takeoff Funktion \ Сиденье съемное из термоотверждающейся смолы с плавным опусканием 		CPVSMNEWF(X)*	2,30	 Le Acque di Cielo *	273,00		
 Impact and acoustic protection panel Protección antigolpes y acústica \ Protection acoustique et anti-choc \ Stoss-und Schalldämmung \ Противоударная и акустическая защита		PAA	0,16		15,00		
 Couple of fixing brackets for wall-hung wc/bidet Pareja de estribo para Inodoro/ Bidet suspendido \ Étriers de fixation pour Wc/Bidet suspendus \ 1 Paar Halterungen für wandhängendes Wc/Bidet \ Монтажная рама для подвесного унитаза/биде		508	3,30		35,00		

* Le Acque di Cielo      





Technical symbols legend







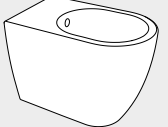

 wall-hung installation instalación suspendida installation suspendue wandhängende Montage подвесная установка	 with fixing parts fijaciones incluidas fixations incluses inklusive Befestigung в комплекте с крепежами	 4,5 l toilet tank descarga 4,5 l évacuation à 4,5 l 4,5 l-Spülung бачок на 4,5 л	 Combifix compatibility compatible Combifix mit Combifix kompatibel совместим с combifix	 quick release hinge sistema extraíble charnières à ouverture Takeoff Funktion быстрый съем	 rimless sin brida sans bride ohne Spülrand без ободка
--	--	---	---	---	--

Smile 48 wc back to wall	Size (cm) Medidas Dimensions Maße Размеры	Product code Artículo Article Artikel Артикул	Net weight (kg) Peso neto Poids net Reingewicht вес нетто	Finishes Acabados Finitions Farbe Отделки	Euro Евро	Pz. pallet Italia	Pz. pallet Cont.
 <p>MINI wc with floor trap (4,5 LT) Inodoro MINI con salida a suelo (4,5 LT) Cuvette avec sortie au sol MINI (4,5 LT) Stand-WC Abgang senkrecht MINI (4,5 LT) Унитаз со сливом в пол MINI (4,5 л)</p>	48 x 35 x 42 h	SMVASR(X)*	25,20	 Le Acque di Cielo *	544,00	15	20
 <p>MINI wc with wall trap (4,5 LT) Inodoro MINI con salida a pared (4,5 LT) Cuvette avec sortie à mur MINI (4,5 LT) Stand-WC Abgang waagrecht MINI (4,5 LT) Унитаз со сливом в стену MINI (4,5 л)</p>	48 x 35 x 42 h	SMVAPR(X)*	25,20	 Le Acque di Cielo *	544,00	15	20
 <p>Thermosetting contoured wrap lid soft close seat & cover Asiento para inodoro amortiguado Abattant thermoturcissable soft Wc-sitz thermoturcissable mit Abs. Сиденье из термоотверждающейся смолы, с плавным опусканием</p>		CPVSMF(X)*	3,00	 Le Acque di Cielo *	273,00		
 <p>Thermosetting slim double flap soft close seat & cover with quick release hinges Asiento para inodoro amortiguado bisagra con sistema extraíble Abattant thermoturcissable soft avec charnières à ouverture Wc-sitz in thermoturcissable mit soft-closet und Takeoff Funktion Сиденье съемное из термоотверждающейся смолы с плавным опусканием</p>		CPVSMNEWF(X)*	2,30	 Le Acque di Cielo *	273,00		

* Le Acque di Cielo  OL - Oltremare  SM - Smeraldo  AL - Alga  CO - Corallo  NI - Ninfea  AM - Anemone





Technical symbols legend









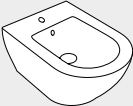

 back to wall installation instalación a suelo installation à terre bodenstehende Montage напольная установка	 with fixing parts fijaciones incluidas fixations incluses inklusive Befestigung- en \ в комплекте с крепежами	 4,5 l toilet tank descarga 4,5 lt évacuation à 4,5 l 4,5 l-Spülung Бачок на 4,5 л	 quick release hinge sistema extraíble charnières à ouverture Takeoff Funktion быстрый съем
--	--	---	--

Smile 48 bidet back to wall	Size (cm) Medidas Dimensions Maße Размеры	Product code Artículo Article Artikel Артикул	Net weight (kg) Peso neto Poids net Reingewicht вес нетто	Finishes Acabados Finitions Farbe Отделки	Euro Евро	Pz. pallet Italia	Pz. pallet Cont.
 <p>MINI bidet back to wall one-hole bidet Bidet monoagujero a suelo MINI Bidet MINI monotrou Stand-Bidet MINI einloch Биде напольное MINI с одним отверстием под смеситель</p>	48 x 35 x 42 h	SMBIDR(X)*	22,50	 Le Acque di Cielo *	544,00	15	20
 <p>Universal click-clack drain in CHROME with ceramic lid Válvula universal click-clack Cromado con tapa en cerámica \ Bonde universelle clic-clac Chromé avec clapet en céramique \ Universal-Ablaufgarnitur Click- Clack Chrom mit Keramikstopfen \ Универсальный донный клапан click/clack хром с керамической крышкой</p>		PIL01(X)*	0,40	 Le Acque di Cielo *	120,00		
 <p>Universal click-clack drain in BLACK MATT finish with ceramic lid Válvula universal click-clack Negro Matt con tapa en cerámica \ Bonde universelle clic-clac Noir Mat avec clapet en céramique \ Universal-Ablaufgarnitur Click-Clack Matt Schwarz mit Keramikstopfen \ Универсальный донный клапан click/clack черный матовый с керамической крышкой</p>		PIL01NM(X)*	0,40	 Le Acque di Cielo *	146,00		
 <p>Universal click-clack drain in CEMENTO finish with ceramic lid Válvula universal click-clack Cemento con tapa en cerámica Bonde universelle clic-clac Cemento avec clapet en céramique \ Universal-Ablaufgarnitur Click-Clack Cement mit Keramikstopfen \ Универсальный донный Cemento click/clack с керамической крышкой</p>		PIL01CM(X)*	0,40	 Le Acque di Cielo *	146,00		

* Le Acque di Cielo  OL - Oltremare  SM - Smeraldo  AL - Alga  CO - Corallo  NI - Ninfea  AM - Anemone

Technical symbols legend





 one tap hole monotrou 1-Loch одно отверстие под смеситель	 with overflow con rebosadero avec trop-plein mit Überlauf с переливом	 back to wall installation instalación a suelo installation à terre bodenstehende Montage напольная установка	 with fixing parts fijaciones incluidas fixations incluses inklusive Befestigungen в комплекте с крепежами
---	---	--	---

<p>Enjoy 53 bidet wall-hung</p>  <p>Wall-hung one hole bidet with fixing kit Bidé suspendido monoagujero completo con fijaciones \ Bidet suspendu monotrou avec fixation \ Wand-Bidet einloch mit Befestigungskit \ Биде подвесное с одним отверстием под смеситель, в комплекте с крепежами</p> 	<p>Size (cm) Medidas Dimensions Maße Размеры</p>	<p>Product code Artículo Article Artikel Артикул</p>	<p>Net weight (kg) Peso neto Poids net Reingewicht вес нетто</p>	<p>Finishes Acabados Finitions Farbe Отделки</p>	<p>Euro Евро</p>	<p>Pz. pallet Italia</p>	<p>Pz. pallet Cont.</p>
<p>53 x 35 x 26,5 h</p>	<p>EJBS(X)*</p>	<p>17,60</p>	<p> Le Acque di Cielo *</p>	<p>567,00</p>	<p>18</p>	<p>18</p>	
<p> Universal click/clack drain in CHROME with ceramic lid - Válvula universal click/clack Cromado con tapa en cerámica - Bonde universelle clic/clac Chromé avec clapet en céramique - Universal-Ablaufgarnitur Click-Clack Chrom mit Keramikstopfen - Универсальный донный клапан click/clack хром с керамической крышкой</p>	<p>PIL01(X)*</p>	<p>0,40</p>	<p> Le Acque di Cielo *</p>	<p>120,00</p>			
<p> Universal click/clack drain in BLACK MATT finish with ceramic lid - Válvula universal click/clack Negro Matt con tapa en cerámica - Bonde universelle clic/clac Noir Mat avec clapet en céramique - Universal-Ablaufgarnitur Click-Clack Matt Schwarz mit Keramikstopfen - Универсальный донный клапан click/clack черный матовый с керамической крышкой</p>	<p>PIL01NM(X)*</p>	<p>0,40</p>	<p> Le Acque di Cielo *</p>	<p>146,00</p>			
<p> Universal click/clack drain in CEMENTO finish with ceramic lid - Válvula universal click/clack Cemento con tapa en cerámica - Bonde universelle clic/clac Cemento avec clapet en céramique - Universal-Ablaufgarnitur Click-Clack Cement mit Keramikstopfen - Универсальный донный клапан Cemento click/clack с керамической крышкой</p>	<p>PIL01CM(X)*</p>	<p>0,40</p>	<p> Le Acque di Cielo *</p>	<p>146,00</p>			
<p> Impact and acoustic protection panel Protección antigolpes y acústica \ Protection acoustique et anti-choc \ Stoss-und Schalldämmung \ Противоударная и акустическая защита</p>	<p>PAA</p>	<p>0,16</p>		<p>15,00</p>			
<p> Couple of fixing brackets for wall-hung wc/bidet Pareja de estribo para Inodoro/ Bidet suspendido \ Étriers de fixation pour Wc/Bidet suspendus \ 1 Paar Halterungen für wandhängendes Wc/Bidet - Монтажная рама для подвесного унитаза/биде</p>	<p>508</p>	<p>3,30</p>		<p>35,00</p>			

* Le Acque di Cielo  OL - Oltremare  SM - Smeraldo  AL - Alga  CO - Corallo  NI - Ninfea  AM - Anemone

Technical symbols legend





 one tap hole con 1 agujero monotrou 1-Loch одно отверстие под смеситель	 with overflow con rebosadero avec trop-plein mit Überlauf с переливом	 back to wall installation instalación a suelo installation à terre bodenstehende Montage напольная установка	 with fixing parts fijaciones incluidas fixations incluses inklusive Befestigungen в комплекте с крепежами
---	--	---	--

Enjoy 53 wc wall-hung	Size (cm) Medidas Dimensions Maße Размеры	Product code Artículo Article Artikel Артикул	Net weight (kg) Peso neto Poids net Reingewicht вес нетто	Finishes Acabados Finitions Farbe Отделки	Euro Евро	Pz. pallet Italia	Pz. pallet Cont.
 <p>Wall-hung wc with fixing kit (4,5 LT) Wc suspendido completo con fijaciones (4,5 LT) \ Wc suspendu avec fixation (4,5 LT) Wand-WC mit Befestigungskit (4,5 LT) Унитаз подвесной в комплекте со крепежами (4,5 LT)</p> <p>⌋ ⌋ C ⌋</p>	53 x 35 x 26,5 h	EJVS(X)*	18,25	● Le Acque di Cielo *	567,00	18	18
 <p>Thermosetting slim double flap soft close seat & cover with quick release hinges Asiento para inodoro amortiguado bisagra con sistema extraíble \ Abattant thermodurcissable soft avec charnières à ouverture \ Wc sitz in thermodur mit soft-closet und Takeoff Funktion \ Сиденье съемное из термоотверждающейся смолы с плавным опусканием</p> <p>⌋</p>		CPVEJNEWF(X)*	2,30	● Le Acque di Cielo *	273,00		
 <p>Impact and acoustic protection panel Protección antigolpes y acústica \ Protection acoustique et anti-choc \ Stoss-und Schalldämmung \ Противоударная и акустическая защита</p>		PAA	0,16		15,00		
 <p>Couple of fixing brackets for wall-hung wc/bidet Pareja de estribo para Inodoro/ Bidet suspendido \ Étriers de fixation pour Wc/Bidet suspendus \ 1 Paar Halterungen für wandhängendes Wc/Bidet Монтажная рама для подвесного унитаза/биде</p>		508	3,30		35,00		

* Le Acque di Cielo ● OL - Oltremare ● SM - Smeraldo ● AL - Alga ● CO - Corallo ● NI - Ninfea ● AM - Anemone

Technical symbols legend







⌋ wall-hung installation instalación suspendida installation suspendue wandhängende Montage подвесная установка	⌋ with fixing parts fijaciones incluidas fixations incluses inklusive Befestigung- gen \ в комплекте с крепежами	⌋ 4,5 l toilet tank descarga 4,5 l évacuation à 4,5 l 4,5 l-Spülung бачок на 4,5 л	⌋ Combifix compatibility compatibile Combifix mit Combifix kompatibel совместим с combifix	⌋ quick release hinge sistema extraíble charnières à ouverture Takeoff Funktion быстрый съем
---	---	--	---	--

Enjoy 53 wc wall-hung - rimless	Size (cm) Medidas Dimensions Maße Размеры	Product code Artículo Article Artikel Артикул	Net weight (kg) Peso neto Poids net Reingewicht вес нетто	Finishes Acabados Finitions Farbe Отделки	Euro Евро	Pz. pallet Italia	Pz. pallet Cont.
 <p>Wall-hung wc with fixing kit (4,5 LT) - rimless Wc suspendido completo con fijaciones (4,5 LT) - sin brida / Wc suspendu avec fixations (4,5 LT) - sans bride Wand-WC mit Befestigungskit (4,5 Lt.) - ohne Spülrand Подвесной унитаз в комплекте с крепежами (4,5 литр) - без ободка</p> <p>⌋ ⌋ C K ⌋</p>	53 x 35 x 26,5 h	EJVS(X)*	19,40	● Le Acque di Cielo *	567,00	18	18
 <p>Thermosetting slim double flap soft close seat & cover with quick release hinges Asiento para inodoro amortiguado bisagra con sistema extraíble \ Abattant thermodurcissable soft avec charnières à ouverture \ Wc sitz in thermodur mit soft-closet und Takeoff Funktion \ Сиденье съемное из термоотверждающейся смолы с плавным опусканием</p> <p>⌋</p>		CPVEJNEWF(X)*	2,30	● Le Acque di Cielo *	273,00		
 <p>Impact and acoustic protection panel Protección antigolpes y acústica \ Protection acoustique et anti-choc \ Stoss-und Schalldämmung \ Противоударная и акустическая защита</p>		PAA	0,16		15,00		
 <p>Couple of fixing brackets for wall-hung wc/bidet Pareja de estribo para Inodoro/ Bidet suspendido \ Étriers de fixation pour Wc/Bidet suspendus \ 1 Paar Halterungen für wandhängendes Wc/Bidet Монтажная рама для подвесного унитаза/биде</p>		508	3,30		35,00		

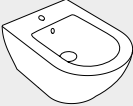
* Le Acque di Cielo ● OL - Oltremare ● SM - Smeraldo ● AL - Alga ● CO - Corallo ● NI - Ninfea ● AM - Anemone

Technical symbols legend

⌋ with fixing parts fijaciones incluidas fixations incluses inklusive Befestigung- gen \ в комплекте с крепежами	⌋ wall-hung installation instalación suspendida installation suspendue wandhängende Montage подвесная установка	⌋ Combifix compa- tibility compatibile Combifix mit Combifix kompatibel совместим с combifix	K rimless sin brida sans bride ohne Spülrand без ободка	⌋ 4,5 l toilet tank descarga 4,5 l évacuation à 4,5 l 4,5 l-Spülung бачок на 4,5 л	⌋ quick release hinges sistema extraíble charnières à ouverture Takeoff Funktion быстрый съем
---	---	--	---	--	---

Enjoy 48 bidet wall-hung	Size (cm) Medidas Dimensions Maße Размеры	Product code Artículo Article Artikel Артикул	Net weight (kg) Peso neto Poids net Reingewicht вес нетто	Finishes Acabados Finitions Farbe Отделки	Euro Евро	Pz. pallet Italia	Pz. pallet Cont.
 <p>Wall-hung one hole MINI bidet with fixing kit Bidé MINI suspendido monoagujero completo con fijaciones \ Bidet MINI suspendu monotrou avec fixation \ Wand-Bidet MINI einloch mit BefestigungsKit \ MINI Биде подвесное с одним отверстием под смеситель, в комплекте с крепежами</p> <p>48 x 35 x 26,5 h</p> <p>EJBSR(x)* 16,00</p> <p>Le Acque di Cielo * 556,00 18 18</p> <p>□ ○ ⊥ ⚙</p>							
 <p>Universal click/clack drain in CHROME with ceramic lid - Válvula universal click/clack Cromado con tapa en cerámica - Bonde universelle clic/clac Chromé avec clapet en céramique - Universal-Ablaufgarnitur Click-Clack Chrom mit Keramikstopfen - Универсальный донный клапан click/clack хром с керамической крышкой</p> <p>PIL01(x)* 0,40</p> <p>Le Acque di Cielo * 120,00</p>							
 <p>Universal click/clack drain in BLACK MATT finish with ceramic lid - Válvula universal click/clack Negro Matt con tapa en cerámica - Bonde universelle clic/clac Noir Mat avec clapet en céramique - Universal-Ablaufgarnitur Click-Clack Matt Schwarz mit Keramikstopfen - Универсальный донный клапан click/clack черный матовый с керамической крышкой</p> <p>PIL01NM(x)* 0,40</p> <p>Le Acque di Cielo * 146,00</p>							
 <p>Universal click/clack drain in CEMENTO finish with ceramic lid - Válvula universal click/clack Cemento con tapa en cerámica - Bonde universelle clic/clac Cemento avec clapet en céramique - Universal-Ablaufgarnitur Click-Clack Cement mit Keramikstopfen - Универсальный донный Cemento click/clack с керамической крышкой</p> <p>PIL01CM(x)* 0,40</p> <p>Le Acque di Cielo * 146,00</p>							
 <p>Impact and acoustic protection panel Protección antigolpes y acústica \ Protection acoustique et anti-choc \ Stoss-und Schalldämmung \ Противоударная и акустическая защита</p> <p>PAA 0,16</p> <p>15,00</p>							
 <p>Couple of fixing brackets for wall-hung wc/bidet Pareja de estribo para Inodoro/ Bidet suspendido \ Étriers de fixation pour Wc/Bidet suspendus \ 1 Paar Halterungen für wandhängendes Wc/Bidet \ Монтажная рама для подвесного унитаза/биде</p> <p>508 3,30</p> <p>35,00</p>							

* Le Acque di Cielo ● OL - Oltremare ● SM - Smeraldo ● AL - Alga ● CO - Corallo ● NI - Ninfea ● AM - Anemone





Technical symbols legend

○ one tap hole con 1 agujero monotrou 1-Loch одно отверстие под смеситель

□ with overflow avec trop-plein mit Überlauf с переливом

▭ back to wall installation instalación a suelo installation à terre bodenstehende Montage напольная установка

⚙ with fixing parts fijaciones incluidas fixations incluses inklusive Befestigungen в комплекте с крепежами

Enjoy 48 wc wall-hung - rimless	Size (cm) Medidas Dimensions Maße Размеры	Product code Artículo Article Artikel Артикул	Net weight (kg) Peso neto Poids net Reingewicht вес нетто	Finishes Acabados Finitions Farbe Отделки	Euro Евро	Pz. pallet Italia	Pz. pallet Cont.
 <p>Wall-hung MINI wc with fixing kit (4.5 LT) - rimless Wc suspendido MINI completo con fijaciones (4.5 LT) - sin brida / Wc MINI suspendu avec fixations (4.5 LT) - sans bride Wand-WC MINI mit BefestigungsKit (4,5 Lt.) - MINI ohne Spülrand Подвесной унитаз в комплекте с крепежами (4,5 литр) - без ободка</p> <p>48 x 35 x 26,5 h</p> <p>EJVSKR(x)* 17,00</p> <p>Le Acque di Cielo * 599,00 18 18</p> <p>⚙ ⊥ C K</p>							
 <p>Thermosetting slim double flap soft close seat & cover with quick release hinges Asiento para inodoro amortiguado bisagra con sistema extraíble \ Abattant thermodurcissable soft avec charnières à ouverture \ Wc sitz in thermodur mit soft-closet und Takeoff Funktion \ Сиденье съемное из термоотверждающейся смолы с плавным опусканием</p> <p>CPVEJNEWF(x)* 2,30</p> <p>Le Acque di Cielo * 273,00</p>							
 <p>Impact and acoustic protection panel Protección antigolpes y acústica \ Protection acoustique et anti-choc \ Stoss-und Schalldämmung \ Противоударная и акустическая защита</p> <p>PAA 0,16</p> <p>15,00</p>							
 <p>Couple of fixing brackets for wall-hung wc/bidet Pareja de estribo para Inodoro/ Bidet suspendido \ Étriers de fixation pour Wc/Bidet suspendus \ 1 Paar Halterungen für wandhängendes Wc/Bidet \ Монтажная рама для подвесного унитаза/биде</p> <p>508 3,30</p> <p>35,00</p>							

* Le Acque di Cielo ● OL - Oltremare ● SM - Smeraldo ● AL - Alga ● CO - Corallo ● NI - Ninfea ● AM - Anemone

Technical symbols legend

⚙ wall-hung installation instalación suspendida installation suspendue wandhängende Montage подвесная установка











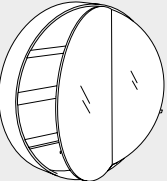





⚙ with fixing parts fijaciones incluidas fixations incluses inklusive Befestigungen в комплекте с крепежами

🗑 4,5 l toilet tank descarga 4,5 l évacuation à 4,5 l 4,5 l-Spülung бачок на 4,5 л







⚙ Combifix compatibility compatible Combifix mit Combifix kompatibel совместим с combifix

⚙ quick release hinge sistema extraíble charnières à ouverture Takeoff Funktion быстрый съем





K rimless sin brida sans bride ohne Spülrand без ободка

Mirrors 	Size (cm) Medidas Dimensions Maße Размеры	Product code Artículo Article Artikel Артикул	Net weight (kg) Peso neto Poids net Reingewicht вес нетто	Finishes Acabados Finitions Farbe Отделки  Le Acque di Cielo *  *X = NM - Matt Black  *X = CM - Cemento	Euro Евро	Pz. pallet Italia	Pz. pallet Cont.
ROUND BOX Round mirror cabinet with lacquered box Espejo contenedor redondo con borde lacado Meuble à miroir rond avec corps laqué Spiegelschrank rund Gestell lackiert Зеркальный шкафчик круглый с крашенной рамой	Ø90 x 12 	CASPCT(X)*	27,50	  Le Acque di Cielo *  *X = NM - Matt Black  *X = CM - Cemento	2196,00 1505,00 1691,00		
OVAL BOX Oval mirror cabinet with lacquered box Espejo contenedor ovalado con borde lacado Meuble à miroir ovale avec corps laqué Spiegelschrank oval, Gestell lackiert Зеркальный шкафчик овальный с крашенной рамой	50 x 12 x 90 h	CASPCO(X)*	17,00	  Le Acque di Cielo *  *X = NM - Matt Black  *X = CM - Cemento	1859,00 1155,00 1307,00		
SIMPLE BOX Horizontal mirror cabinet with lacquered shell Espejo horizontal contenedor con capa lacada / Miroir horizontal, armoire de toilette structure laquée / Horizontaler Spiegelschrank mit lackiertem Korpus / Зеркальный шкафчик горизонтальный с крашенным корпусом	90 x 12 x 45 h	SPSB(X)*	18,50	  Le Acque di Cielo *  *X = NM - Matt Black  *X = CM - Cemento	1639,00 940,00 1081,00		
SIMPLE TALL BOX Vertical mirror cabinet with lacquered shell, reversible Espejo vertical contenedor con capa lacada, reversible / Miroir vertical, armoire de toilette structure laquée, reversible / Vertikaler Spiegelschrank mit lackiertem Korpus - reversibel / Зеркальный шкафчик вертикальный с крашенным корпусом - реверсивный	45 x 12 x 110 h	SPSTB(X)*	22,00	  Le Acque di Cielo *  *X = NM - Matt Black  *X = CM - Cemento	1529,00 842,00 968,00		



* Le Acque di Cielo  OL - Oltremare  SM - Smeraldo  AL - Alga  CO - Corallo  NI - Ninfea  AM - Anemone

Accessories	Size (cm)	Product code	Net weight(Kg)	Finishes	Euro
	Medidas Dimensions Maße Размеры	Artículo Article Artikel Артикул	Peso neto Poids net Reingewicht вес нетто	Acabados Finitions Farbe Отделки	Евро
 <p>ROUND SHELF ESTANTE REDONDO \ ÉTAGÈRE RONDE \ KONSOLE RUND \ Полочка круглая</p> <p>=</p> <p>Round top in back-painted glass Encimera redonda en vidrio pintado por detrás \ Plateau rond en verre laqué à l'arrière \ Platte rund aus rückseitig lackiertem Glas \ Полочка круглая из окрашенного стекла</p>  <p>Round top in Azul Noche stone Encimera redonda en piedra Azul Noche \ Plateau rond en pierre Azul Noche \ Platte rund aus Azul Noche-Stein \ Полочка круглая из гранита Azul Noche</p> <p>+</p> <p>Metal structure for round top Estructura metálica para encimera redonda \ Structure métallique pour plateau rond \ Metallgestell für runde Platte \ Структура из металла для полочки круглой</p> 	Ø 11 x 1,2 h	ACMTV(X)*	0,30	<p>● Le Acque di Cielo *</p> <p>● *X = CM - Cemento</p>	108,00 108,00
	Ø 11 x 1,2 h	ACMTM(X)*	0,25	● *X = AZ Azul Noche	108,00
	Ø 12 x 3 h	ACST(X)*	0,45	<p>● Le Acque di Cielo *</p> <p>● *X = NM - Matt Black</p> <p>● *X = CM - Cemento</p>	109,00 109,00 109,00
 <p>OVAL SHELF ESTANTE OVALADO \ ÉTAGÈRE OVALE \ KONSOLE OVAL \ Полочка овальная</p> <p>=</p> <p>Oval top in back-painted glass Encimera ovalada en vidrio pintado por detrás \ Plateau ovale en verre laqué à l'arrière \ Platte oval aus rückseitig lackiertem Glas \ Полочка овальная из окрашенного стекла</p>  <p>Oval top in Azul Noche stone Encimera ovalada en piedra Azul Noche \ Plateau ovale en pierre Azul Noche \ Platte oval aus Azul Noche-Stein \ Полочка овальная из гранита Azul Noche</p> <p>+</p> <p>Metal structure for oval top Estructura metálica para encimera ovalada \ Structure métallique pour plateau ovale \ Metallgestell für ovale Platte \ Структура из металла для полочки овальной</p> 	23,5 x 10,5 x 1,2 h	ACMOV(X)*	0,70	<p>● Le Acque di Cielo *</p> <p>● Cemento</p>	153,00 153,00
	23,5 x 10,5 x 1,2 h	ACMOM(X)*	0,55	● *X = AZ Azul Noche	153,00
	25 x 12 x 3 h	ACSO(X)*	0,70	<p>● Le Acque di Cielo *</p> <p>● *X = NM - Matt Black</p> <p>● *X = CM - Cemento</p>	160,00 160,00 160,00

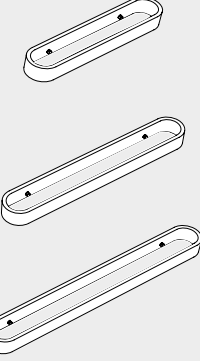
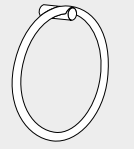

* Le Acque di Cielo ● OL - Oltremare ● SM - Smeraldo ● AL - Alga ● CO - Corallo ● NI - Ninfea ● AM - Anemone

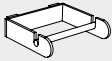
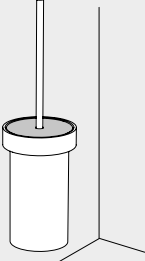
Accessories	Size (cm)	Product code	Net weight(Kg)	Finishes	Euro
	Medidas Dimensions Maße Размеры	Artículo Article Artikel Артикул	Peso neto Poids net Reingewicht вес нетто	Acabados Finitions Farbe Отделки	Евро
 <p>Metal dispenser Dispensador de metal \ Distributeur en métal \ Spender aus Metall \ Диспенсер из металла</p>	Ø6 x 18 h	ACDIM(X)*	0,50	<p>● Le Acque di Cielo *</p> <p>● *X = NM - Matt Black</p> <p>● *X = CM - Cemento</p>	198,00 176,00 176,00
 <p>Metal cup Vaso en metal \ Verre en métal \ Glas aus Metall \ Стаканчик из металла</p>	Ø6 x 11 h	ACBIM(X)*	0,20	<p>● Le Acque di Cielo *</p> <p>● *X = NM - Matt Black</p> <p>● *X = CM - Cemento</p>	73,00 66,00 66,00
 <p>Hook type 1 gancho tipo 1 \ Crochet type 1 \ Aufhänger Typ 1 \ Крючок тип 1</p>	Ø3 x 4	ACGA1(X)*	0,15	<p>● Le Acque di Cielo *</p> <p>● *X = NM - Matt Black</p> <p>● *X = CM - Cemento</p>	81,00 76,00 76,00
 <p>Hook type 2 gancho tipo 2 \ Crochet type 2 \ Aufhänger Typ 2 \ Крючок тип 2</p>	Ø3 x 4	ACGA2(X)*	0,15	<p>● Le Acque di Cielo *</p> <p>● *X = NM - Matt Black</p> <p>● *X = CM - Cemento</p>	81,00 76,00 76,00
 <p>Towel rails, oval version Toallero versión oval Porte-serviette version ovale Handtuchhalter in abgerundeter Ausführung Полотенцедержатель, овальный версия</p>	30 x 6 x h3	ACPT30(X)*	0,81	<p>● Le Acque di Cielo *</p> <p>● *X = NM - Matt Black</p> <p>● *X = CM - Cemento</p>	152,00 146,00 146,00
	45 x 6 x h3	ACPT45(X)*	1,21	<p>● Le Acque di Cielo *</p> <p>● *X = NM - Matt Black</p> <p>● *X = CM - Cemento</p>	185,00 169,00 169,00
	60 x 6 x h3	ACPT60(X)*	1,62	<p>● Le Acque di Cielo *</p> <p>● *X = NM - Matt Black</p> <p>● *X = CM - Cemento</p>	200,00 186,00 186,00
 <p>Ring towel holder Toallero de anilla \ Anneau porte-serviette \ Handtuchring \ Полотенцедержатель-кольцо</p>	Ø 32	ACPA(X)*	0,55	<p>● Le Acque di Cielo *</p> <p>● *X = NM - Matt Black</p> <p>● *X = CM - Cemento</p>	237,00 226,00 226,00

* Le Acque di Cielo ● OL - Oltremare ● SM - Smeraldo ● AL - Alga ● CO - Corallo ● NI - Ninfea ● AM - Anemone

Accessories	Size (cm)	Product code	Net weight(Kg)	Finishes	Euro
 <p>Metal roll holder Porta rotolo en metal \ Porte-rouleau en métal \ Rollenhalter aus Metall \ Держатель туалетной бумаги из металла</p>	12 x 10 x h 3	ACBRA(X)*	0,30	<p>Acabados Finitions Farbe Отделки</p> <p>● Le Acque di Cielo *</p> <p>● *X = NM - Matt Black</p> <p>● *X = CM - Cemento</p>	174,00 164,00 164,00
 <p>TOILET BRUSH, WALL-HUNG INSTALLATION PORTAESCOBILLERO SUSPENDIDO \ PORTE-BROSSE MURAL \ TOILETTEN-BÜRSTENGARNITUR WANDHÄNGEND \ Ершик для унитаза настенный</p> <p>Metal toilet brush holder, with top in Azul Noche stone and structure for wall mounting \ Portaescobillero en metal, con encimera en piedra Azul Noche y estructura con instalación a pared \ Porte-rouleau en métal, avec plateau en pierre Azul Noche et structure pour fixation au mur \ Toiletten-Bürstengarnitur aus Metall, mit Platte aus Azul Noche-Stein und Struktur für Wandmontage \ Ершик с полочкой из гранита Azul Noche для унитаза из металла, настенный</p> <p>N.B. \ P.D. \ Remarque \ HINWEIS \ Примечание The code identifies the finish of the marble top, the (x) * represents the finish of the metal parts. Example: ACPSSAZ / CM indicates a toilet brush holder with an Azul Noche stone top and metal parts in a Cemento finish (/ CM). El código identifica el acabado de la encimera de mármol, la (x) * representa el acabado de las partes metálicas. Ejemplo: ACPSSAZ/CM indica un portaescobillas con base de piedra Azul Noche y partes metálicas en acabado Cemento (/ CM). Le code permet d'identifier la finition du plateau en marbre. La mention (x)* représente la finition des parties métalliques. Exemple : ACPSSAZ/CM fait référence à un porte-brosse avec un plateau en pierre Azul Noche et des parties métalliques en finition Cemento (/CM). Der Code kennzeichnet die Ausführung der Marmorplatte, das (x)* bezieht sich auf die Ausführung der Metallteile. Beispiel: ACPSSAZ/CM ist eine Toiletten-Bürstengarnitur mit Platte aus Azul Noche-Stein und Metallteilen in der Ausführung Zement (/CM). Код обозначает отделку полочки из мрамора, (x) * обозначает отделку деталей из металла. Например: ACPSSAZ / CM обозначает туалетный ершик с полочкой из гранита Azul Noche и деталями из металла в отделке Cemento (/ CM).</p>	Ø 12 x 42 h	ACPSSAZ(X)*	1,00	<p>AZUL NOCHE STONE TOP ENCIMERA EN PIEDRA AZUL NOCHE PLATEAU EN PIERRE AZUL NOCHE PLATTE AUS AZUL NOCHE-STEIN Полочка из гранита Azul Noche</p> <p>● Azul Noche</p> <p>METAL PARTS FINISHES ACABADOS PARTES METALICAS FINITIONS PARTIES METALLIQUES AUSFÜHRUNGEN METALLTEILE Отделка частей из металла</p> <p>● Le Acque di Cielo *</p> <p>● *X = NM - Matt Black</p> <p>● *X = CM - Cemento</p>	403,00
 <p>Metal toilet brush holder, with top in back-painted glass and structure for wall mounting Portaescobillero en metal, con encimera en vidrio pintado por detrás y estructura para instalación a pared \ Porte-rouleau en métal, avec plateau en verre laqué à l'arrière et structure pour fixation au mur \ Toiletten-Bürstengarnitur aus Metall, mit Platte aus rückseitig lackiertem Glas und Struktur für Wandmontage \ Ершик для унитаза из металла, с полочкой из окрашенного стекла, настенный</p> <p>N.B. \ P.D. \ Remarque \ HINWEIS \ Примечание The code identifies the finish of the glass top, the (x) * represents the finish of the metal parts. Example: ACPSSOL/CM indicates a toilet brush holder with a glass top in an Oltremare finish (ACPSSOL) and metal parts in a Cement finish (/CM). El código identifica el acabado de la encimera de vidrio, la (x) * representa el acabado de las partes metálicas. Ejemplo: ACPSSOL / CM indica un portaescobillas con base de vidrio en acabado Oltremare (ACPSSOL) y piezas metálicas en acabado Cemento (/ CM). Der Code kennzeichnet die Ausführung der Glasplatte, das (x)* bezieht sich auf die Ausführung der Metallteile. Beispiel: ACPSSOL/CM ist eine Toiletten-Bürstengarnitur mit Platte aus Glas in der Ausführung Oltremare (ACPSSOL) und Metallteilen in der Ausführung Zement (/CM). Le code permet d'identifier la finition du plateau en verre. La mention (x)* représente la finition des parties métalliques. Exemple : ACPSSOL/CM fait référence à un porte-brosse avec un plateau en verre en finition Oltremare (ACPSSOL) et des parties métalliques en finition Cemento (/ CM). Код обозначает отделку полочку из стекла, (x) * обозначает отделку деталей из металла. Например: ACPSSOL/CM обозначает туалетный ершик с полочкой из стекла в отделке Oltremare (ACPSSOL) и деталями из металла в отделке Cemento (/ CM).</p>	Ø 12 x 42 h	ACPSSOL(X)* ACPSSSM(X)* ACPSSAL(X)* ACPSSCO(X)* ACPSSNI(X)* ACPSSAM(X)* ACPSSCM(X)*	1,50	<p>GLASS TOP FINISHES ACABADOS ENCIMERAS EN VIDRIO FINITIONS PLATEAU EN VERRE AUSFÜHRUNGEN GLASPLATTE Отделка полочки из стекла</p> <p>● Oltremare</p> <p>● Smeraldo</p> <p>● Alga</p> <p>● Corallo</p> <p>● Ninfea</p> <p>● Anemone</p> <p>● Cemento</p> <p>METAL PARTS FINISHES ACABADOS PARTES METALICAS FINITIONS PARTIES METALLIQUES AUSFÜHRUNGEN METALLTEILE Отделка частей из металла</p> <p>● Le Acque di Cielo *</p> <p>● *X = NM - Matt Black</p> <p>● *X = CM - Cemento</p>	429,00

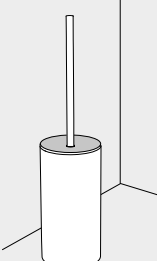
* Le Acque di Cielo ● OL - Oltremare ● SM - Smeraldo ● AL - Alga ● CO - Corallo ● NI - Ninfea ● AM - Anemone

Accessories	Size (cm)	Product code	Net weight(Kg)	Finishes	Euro
 <p>FLOOR-STANDING TOILET BRUSH HOLDER PORTAESCOBILLERO A SUELO \ PORTE-BROSSE À POSER \ TOILETTEN-BÜRSTENGARNITUR BODENSTEHEND \ Ершик для унитаза напольный</p> <p>Metal toilet brush holder with top in Azul Noche stone, floor installation Portaescobillero en metal con encimera en piedra Azul Noche, instalación en tierra \ Porte-rouleau en métal avec plateau en pierre Azul Noche, installation au sol \ Toiletten-Bürstengarnitur aus Metall mit Platte aus Azul Noche-Stein, Bodeninstallation \ Ершик для унитаза из металла с полочкой из гранита Azul Noche, наземная установка</p> <p>N.B. \ P.D. \ Remarque \ HINWEIS \ Примечание The code identifies the finish of the marble top, the (x) * represents the finish of the metal parts. Example: ACPSTAZ/CM indicates a toilet brush holder with an Azul Noche stone top and metal parts in a Cemento finish (/CM). El código identifica el acabado de la encimera de mármol, la (x) * representa el acabado de las partes metálicas. Ejemplo: ACPSTAZ/CM indica un portaescobillas con base de piedra Azul Noche y partes metálicas en acabado Cemento (/ CM). Le code permet d'identifier la finition du plateau en marbre. La mention (x)* représente la finition des parties métalliques. Exemple : ACPSTAZ/CM fait référence à un porte-brosse avec un plateau en pierre Azul Noche et des parties métalliques en finition Cemento (/CM). Der Code kennzeichnet die Ausführung der Marmorplatte, das (x)* bezieht sich auf die Ausführung der Metallteile. Beispiel: ACPSTAZ/CM ist eine Toiletten-Bürstengarnitur mit Platte aus Azul Noche-Stein und Metallteilen in der Ausführung Zement (/CM). Код обозначает отделку полочки из мрамора, (x) * обозначает отделку деталей из металла. Например: ACPSTAZ/CM обозначает туалетный ершик с полочкой из гранита Azul Noche и деталями из металла в отделке Cemento (/CM).</p>	Ø 12 x 42 h	ACPSTAZ(X)*	0,75	<p>AZUL NOCHE STONE TOP ENCIMERA EN PIEDRA AZUL NOCHE PLATEAU EN PIERRE AZUL NOCHE PLATTE AUS AZUL NOCHE-STEIN Полочка из гранита Azul Noche</p> <p>● Azul Noche</p> <p>METAL PARTS FINISHES ACABADOS PARTES METALICAS FINITIONS PARTIES METALLIQUES AUSFÜHRUNGEN METALLTEILE Отделка частей из металла</p> <p>● Le Acque di Cielo *</p> <p>● *X = NM - Matt Black</p> <p>● *X = CM - Cemento</p>	325,00
 <p>Metal toilet brush holder with top in back-painted glass, floor installation Portaescobillero en metal con encimera en vidrio pintado por detrás, instalación en tierra \ Porte-rouleau en métal avec plateau en verre laqué à l'arrière, installation au sol \ Toiletten-Bürstengarnitur aus Metall mit Platte aus rückseitig lackiertem Glas, Bodeninstallation \ Ершик для унитаза из металла с полочкой из окрашенного стекла, наземная установка</p> <p>N.B. \ P.D. \ Remarque \ HINWEIS \ Примечание The code identifies the finish of the glass top, the (x) * represents the finish of the metal parts. Example: ACPSTOL/CM indicates a toilet brush holder with a glass top in an Oltremare finish (ACPSTOL) and metal parts in a Cement finish (/CM). El código identifica el acabado de la encimera de vidrio, la (x) * representa el acabado de las partes metálicas. Ejemplo: ACPSTOL/CM indica un portaescobillas con base de vidrio en acabado Oltremare (ACPSTOL) y piezas metálicas en acabado Cemento (/ CM). Der Code kennzeichnet die Ausführung der Glasplatte, das (x)* bezieht sich auf die Ausführung der Metallteile. Beispiel: ACPSTOL/CM ist eine Toiletten-Bürstengarnitur mit Platte aus Glas in der Ausführung Oltremare (ACPSTOL) und Metallteilen in der Ausführung Zement (/CM). Le code permet d'identifier la finition du plateau en verre. La mention (x)* représente la finition des parties métalliques. Exemple : ACPSTOL/CM fait référence à un porte-brosse avec un plateau en verre en finition Oltremare (ACPSTOL) et des parties métalliques en finition Cemento (/CM). Код обозначает отделку полочку из стекла, (x) * обозначает отделку деталей из металла. Например: ACPSTOL/CM обозначает туалетный ершик с полочкой из стекла в отделке Oltremare (ACPSTOL) и деталями из металла в отделке Cemento (/CM).</p>	Ø 12 x 42 h	ACPSTOL(X)* ACPSTSM(X)* ACPSTAL(X)* ACPSTCO(X)* ACPSTNI(X)* ACPSTAM(X)* ACPSTCM(X)*	0,80	<p>GLASS TOP FINISHES ACABADOS ENCIMERAS EN VIDRIO FINITIONS PLATEAU EN VERRE AUSFÜHRUNGEN GLASPLATTE Отделка полочки из стекла</p> <p>● Oltremare</p> <p>● Smeraldo</p> <p>● Alga</p> <p>● Corallo</p> <p>● Ninfea</p> <p>● Anemone</p> <p>● Cemento</p> <p>METAL PARTS FINISHES ACABADOS PARTES METALICAS FINITIONS PARTIES METALLIQUES AUSFÜHRUNGEN METALLTEILE Отделка частей из металла</p> <p>● Le Acque di Cielo *</p> <p>● *X = NM - Matt Black</p> <p>● *X = CM - Cemento</p>	358,00

* Le Acque di Cielo ● OL - Oltremare ● SM - Smeraldo ● AL - Alga ● CO - Corallo ● NI - Ninfea ● AM - Anemone

Condizioni di vendita \ Sale terms

en

1. ORDERS

The orders, binding on the customer, must always be considered "unless expressly acceptance of the company".

2. PRICES

The prices in this list concern the goods delivered ex-factory. All the invoice costs are at the expense of the customer. The prices are only suggestive and susceptible of change without notice.

3. PAYMENT

Every invoice must be settled separately even if there are residuals of orders to be fulfilled. The late payment will cause the application of the interests of default. The contestation of the goods doesn't give the customer the right to suspend or delay the payment.

4. PACKAGING

On shipping with a taxable amount lower than 600,00 Eur a fixed amount of 18,00 Eur for packaging fees would be charged.

For taxable amounts exceeding the above amount, will be applied a 3% packaging fee.

5. WEIGHT DETAILS - MEASURES - TECHNICALS

Weights and dimensions of items in ceramic are subject to slight variations and must be considered approximate; dimensions quoted at the store or listed in catalogues and price lists may have slight differences due to factory tolerance of ceramic articles. Weights may vary up to 20%. In order to improve our products, Ceramica Cielo LTD reserves the right to vary technical specifications, shape and dimensions quoted at any time and without prior notice.

6. SHIPMENTS

The order can be executed by Ceramica Cielo in multiple shipments. Even though it will be dispatched by Ceramica Cielo or on its behalf, the goods travel at the expense, risk and peril of the Buyer, who remains responsible for any breaks or shortages.

7. DELIVERY

The date of the delivery is always suggestive. The delivery is considered done when the goods are at disposal in our factory in Fabrica di Roma.

8. WARRANTY

The warranty is, in any case, exclusively limited, to the replacement of the goods and subject to compliance with the terms of the law of discovery and dispute, with the exclusion of any other service and accessory charge. In fact, the company will not be responsible for any costs and charges related to assembly, disassembly, installation, etc. for any reason whatsoever. Claims or complaints will not be accepted if not communicated within eight days of the receipt of the goods. Complaints or defects after installation will not be considered if the defected flaw was visible and /or verifiable before installation. Installation implies acceptance of the article itself. The guarantee does not cover defects that, derive from a use that does not conform to the type of product; tampering, alterations, normal deterioration of use, unsuitable maintenance, etc. excluding any responsibility for the use of aggressive, abrasive products, etc. that can deteriorate surfaces. The duration of the product warranty is set at two years from the date of purchase of the product.

9. PLACE OF JURISDICTION

For the settlement or definition of any disputes or controversy of any kind and/or nature, the Court of Viterbo (Italy) will be the exclusive place of jurisdiction of the Italian law, even if the contract is agreed/signed elsewhere.

10. ONLINE SELLING

Ceramica Cielo does not authorise the sale its products through internet sites or portals, unless expressly authorised.

These general conditions shall be considerate fully accepted by customer in case of purchase .

sp

1. PEDIDOS

Los pedidos se comprenden "salvo expresa aceptación de la Casa".

2. PERCIOS

Los precios indicados en esta lista se entienden como franco fábrica. Todos los gastos complementarios derivados de la compra son de exclusivo cargo del comprador. Los precios son puramente indicativos y susceptibles de variación sin previo aviso

3. PAGOS

Cada factura debe ser abonada separadamente, aunque existan restos de pedidos por entregar. El atraso en el pago causará la aplicación de los intereses de mora.

En caso de reclamación de cualquier naturaleza el comprador no tiene derecho a suspender los pagos.

4. EMBALAJE

En todos los envíos con importe inferior a 600.00 euro se aplicará en factura un cargo fijo de 18,00 euro. Para importe superior a la cantidad indicada arriba los gastos de embalaje será igual al 3%.

5. PESO - MEDIDAS - TÉCNICO

El peso y el tamaño de los artículos de cerámica son sometidos a ligeras variaciones y deben considerarse aproximados; las medidas que figuran en los catálogos o listas de precios, pueden tener ligeras diferencias debido a tolerancias de fabricación de los objetos de cerámica. El peso puede variar hasta un 20%. Con el fin de mejorar los productos Cerámica CIELO Spa se reserva el derecho a modificar en cualquier momento y sin previo aviso las características, forma ,tamaño y dimensiones técnicas.

6. TRANSPORTE

Ceramica Cielo podrá hacer un seguimiento de los envíos. Aunque se envía de Ceramica Cielo o en su nombre, la mercancía viaja a cuenta y riesgo del comprador, quién será el único responsable de roturas o desapariciones."

7. ENTREGA

Las fechas de entrega comunicadas son siempre aproximadas y no compromete en ningún caso a Cerámica cielo y pueden sufrir variaciones debidas a diversos factores ajenos a nuestra voluntad. Nada podrá ser atribuible a Cerámica Cielo, en caso de retrasos en las entregas indicadas inicialmente.

8. GARANTÍA

La garantía está limitada exclusivamente a la sustitución de los productos y está sujeta al cumplimiento de los términos de la ley de descubrimiento y disputa, con la exclusión de cualquier otro servicio y cargo accesorio. De hecho, la empresa no responderá por ningún motivo, sea cual sea el costo y los cargos relacionados con el montaje, desmontaje, instalación, etc. Las reclamaciones o quejas no se admiten si no se llevan a cabo dentro de los ocho días a partir de la recepción de los bienes. No se admitirán reclamaciones después de la instalación, si el defecto es visible y / o verificable antes de la instalación. La instalación implica la aceptación del artículo en sí. La garantía no cubre los defectos que se derivan de un uso inapropiado del producto; manipulación, mantenimiento inadecuado, deterioro normal del uso, etc. excluyendo cualquier responsabilidad por el uso de productos agresivos, abrasivos, etc. eso puede deteriorar las superficies. La duración de la garantía del producto se establece en dos años a partir de la fecha de compra del producto.

9. FORO COMPETENTE

Por la definición de eventuales controversias de cualquier tipo se considerará competente exclusivamente el foro de Viterbo (Italia) y exclusivamente ley italiana

10. VENTA EN LINEA

Ceramica Cielo no autoriza la venta de sus productos a través de sitios web o portales, a menos que esté expresamente autorizado por nuestra parte.

fr

1. COMMANDES

Les commandes, engageantes pour le client, doivent être considérés par contre toujours « sauf acceptation de l’entreprise »

2. PRIX

Les prix des produits sont ex factory. Les coûts accessoires sont à la charge du destinataire. Les prix sont indicatifs et susceptibles des changements sans préavis.

3. PAIEMENT

Chaque facture doit être réglée séparément dans tout cas, aussi s’il y a des commandes restants. Le retard du paiement comporte l’application des intérêts moratoires. N’importe quelle contestation sur la marchandise donne droit au client de suspendre ou retarder le paiement.

4. EMBALLAGE

Pour tous les commandes avec un net montant inférieur à 600.00€ nous appliquerons en facture une contribution fixe pour l’emballage de 18.00€. Pour commandes supérieur au montant susmentionné, les frais d’emballage seront du 3%.

5. POIDS - MESURES - TECHNIQUE

Les poids, les dimensions des articles en céramique sont soumis à de légères variations et doivent être considérés comme approximatifs. Les mesures de chantier, reportées dans les catalogues ou tableaux tarifaires peuvent présenter de légères différences dues aux tolérances de fabrication des articles céramiques. Les poids peuvent subir des variations jusqu’à 20%. Dans le but d’améliorer ses produits Ceramica CIELO Spa se réserve le droit à tout moment et sans préavis d’apporter des variations aux caractéristiques techniques, de formes et dimensions.

6. EXPEDITIONS:

Le service pourra être effectué par Ceramica Cielo, éventuellement en plusieurs fois. Même si la marchandise est expédiée par Ceramica Cielo ou par un de ses sous-traitants, la marchandise voyage aux frais, risques et dépens de l’Acquéreur. Tout éventuel matériel venant à être endommagé ou manquer sera de la responsabilité exclusive de l’Acquéreur.

7. CONSIGNE

Les délais de livraison sont toujours indicatifs et en aucun cas engagés pour Ceramica Cielo. Ils peuvent subir changements à cause de nombreux facteurs. Rien ne peut être imputé à Ceramica Cielo pour retards dans les livraisons initialement indiqués.

8. GARANTIE

La garantie est, dans tous les cas exclusivement limitée au remplacement de la marchandise et subordonnée à l’observation des termes de loi de détection et contestation, en excluant toute autre prestation et charge accessoire. L’entreprise ne répondra en aucun cas et pour aucune raison des coûts et frais engendrés par le montage, démontage et pose sur le chantier, etc. Aucune contestation ou réclamation ne sera admise une fois passé le délai de 8 jours à compter de la réception de la marchandise. Les réclamations ou défauts après la pose ne seront pas pris en examen si le défaut contesté résulte visible ou vérifiable avant l’installation. L’installation implique que le produit est accepté tel qu’il est. La garantie ne couvre pas les vices et défauts dérivant d’une utilisation non conforme au type de produit : modifications, altérations, détérioration normale dû à l’usage, entretien non approprié, etc., et exclue toute responsabilité en cas d’utilisation de produits agressifs ou abrasifs, etc., qui sont susceptibles de détériorer les surfaces. La durée de la garantie du produit est de 2 ans, à compter de sa date d’achat.

9. TRIBUNAL COMPÉTENT

Tout éventuel litige quant au présent contrat, même si celui-ci est stipulé dans un autre pays, est du ressort exclusif de la loi italienne et sera confié à la compétence exclusive du Tribunal de Viterbo.

10. VENTE EN LIGNE

Ceramica Cielo n’autorise en aucun cas la vente de ses produits par le biais de sites ou portails internet, sous réserve d’une autorisation expresse spéciale préalablement accordée.

Cette conditions générales seront considérées comme entièrement acceptées du Client en cas d’achat.

de

1. BESTELLUNGEN

Die Bestellungen, verbindlich für den Kunden, brauchen immer die „ offene Bestätigung von der Firma „ zu haben.

2. PREISE

Die Preise von dieser Preisliste sind immer Ab werk. Die sind nur indikative Preise, die ändern können. Der Kund muss alle weitere Koste bezahlen.

3. BEZAHLUNGEN

Jede Rechnung muss reguliert sein, obwohl es weitere gebliebene Bestellungen zu senden gab. Die Verspätung von der Bezahlung gibt uns Rechts Verzugszins zu applizieren. Keine Reklamation darf dem Kund die Möglichkeit Bezahlungen abzulehnen.

4. VERPACKUNG

Zu jeder Lieferung ab € 600,- wird eine Beteiligung für die Verpackungskosten angefragt, in der Regel sind das 3% vom Warenwert; zu jeder Lieferung unter € 600,-, wird die Beteiligung i.H.v. € 18 € / Lieferung sein.

5. GEWICHTE - MASSE - TECHNISCHE

Gewicht und Abmessungen der Artikel aus Keramik unterliegen geringfügigen Variationen und sind daher als Näherungswerte zu verstehen. Die in den Katalogen und Preislisten angegebenen technischen Maße können leichte Abweichungen aufweisen, die auf die Fertigungstoleranzen von Keramikartikeln zurückzuführen sind. Beim Gewicht kann es zu Variationen von bis zu 20 % kommen. Zum Zwecke einer konstanten Verbesserung ihrer Produkte behält sich Ceramica CIELO Spa vor, die technischen Merkmale, Formen und Abmessungen jederzeit ohne Vorankündigung zu ändern.

6. LIEFERUNG

Aufträge können von Ceramica Cielo auch über mehrere Teillieferungen abgewickelt werden. Der Transport der Ware erfolgt auf Kosten und auf Gefahr des Käufers, auch dann, wenn er von Ceramica Cielo oder auf deren Rechnung vorgenommen wird, und eventuelle Beschädigungen und Fehlmengen gehen ausschließlich zu Lasten des Käufers.

7. ERHALTUNG

Der Liefertermin ist immer indikativ. Die Erhaltung erfolgt durch die Bereitung und die Verfügbarkeit der Ware an unserem Lager von Fabrica di Roma.

8. GEWÄHRLEISTUNG

Die Gewährleistung beschränkt sich in jedem Falle ausschließlich auf den Ersatz der Ware, und unterliegt bezüglich Feststellung und Reklamation der Einhaltung der gesetzlichen Vorschriften, unter Ausschluss aller weiteren Leistungen und Nebenkosten. Das Unternehmen haftet in keinem Fall, gleich aus welchem Grund, für Kosten und Aufwendungen, die durch Montage, Demontage, Installation usw. entstehen. Beanstandungen oder Reklamationen, die nicht innerhalb der Frist von acht Tagen nach Erhalt der Ware vorgenommen werden, gelten als nicht akzeptiert. Reklamationen oder Mängel nach der Installation werden nicht berücksichtigt, falls der beanstandete Mangel vor der Installation sichtbar oder überprüfbar war. Die Installation impliziert die Akzeptanz des Artikels. Die Gewährleistung deckt keine Mängel ab, die durch einen nicht mit dem Produkttyp konformen Einsatz, Manipulationen, Veränderungen, normale Gebrauchsabnutzung, unsachgemäße Unterhaltspflege usw. entstehen, und schließt jede Haftung für den Einsatz aggressiver, scheuernder u.ä. Produkte aus, durch die die Oberflächen Schaden nehmen können. Die Gewährleistungsdauer beträgt zwei Jahre ab Kaufdatum des Produkts.

9. GERICHTSSTAND

Zur Beilegung eventueller Streitigkeiten, gleich welcher Art, ist ausschließlich das Gericht von Viterbo zuständig, und es gilt ferner ausschließlich italienisches Recht, auch wenn der Vertrag an einem anderen Ort geschlossen wurde. Die obigen AGB gelten ab dem Zeitpunkt des Kaufs der Produkte als vom Auftraggeber zur Gänze akzeptiert.

10. ONLINE-VERKAUF

Ceramica Cielo genehmigt keinerlei Online-Verkäufe ihrer Produkte, weder auf Websites im Internet noch über Portale. Hierfür ist unsere ausdrückliche Zustimmung erforderlich.

gu

1. ЗАКАЗЫ

Заказы, полученные от клиентов, считаются принятыми при условии подтверждения принятия данных заказов фабрикой.

2. ЦЕНЫ

Цены, указанные в данном прайс-листе, относятся к товару с учетом поставки «франко-фабрика». Все расходы, сопутствующие покупке, ложатся исключительно на Покупателя. Цены являются ориентировочными и могут претерпевать изменения без какого-либо предупреждения. Указанные цены не включают НДС.

3. ОПЛАТА

Каждая фактура должна оплачиваться отдельно, даже если часть заказа требует дополнительного времени для выполнения. Задержка в оплате приведет к начислению процентов по задолженности. Рекламация на товар не дает Покупателю права приостановить или задержать оплату.

4. УПАКОВКА

На все заказы, стоимость которых не превышает 600 евро, будет начисляться фиксированная сумма на расходы по упаковке в размере 18 евро. Если стоимость заказа превышает вышеуказанную сумму, то расходы на упаковку составят 3%

5. ВЕС - РАЗМЕРЫ - ТЕХНИЧЕСКИЕ

Вес, размеры артикулов из керамики могут быть подвержены небольшим изменениям и должны считаться приблизительными; значения, приведенные в каталогах или прайс-листах, могут слегка отличаться от реальных в связи с производственными допусками для изделий из керамики. Различия в весе могут достигать 20%. С целью совершенствования изделий Ceramica CIELO Spa оставляет за собой право в любой момент и без предупреждения изменять технические характеристики и размерные значения.

6. ОТГРУЗКИ

Заказ может быть отгружен фабрикой Cielo несколькими партиями. Отгрузка осуществляется за счет Покупателя, также на него ложатся все риски, даже в случае отгрузки непосредственно с фабрики или по ее поручению третьими лицами. Исключаются любые возмещения за возможный бой товара или недостачу.

7. ПОСТАВКА

Даты поставки всегда являются ориентировочными и не налагают каких-либо обязательств на Ceramica Cielo, кроме того, они могут изменяться вследствие многочисленных причин, не зависящих от намерений. Поэтому задержки поставок относительно изначально указанных дат не могут вменяться в вину компании Ceramica Cielo.

8. ГАРАНТИЯ

В любом случае, гарантия ограничивается только заменой товара, при условии соблюдения сроков, предусмотренных законом, на обнаружение и заявление о рекламации, любые другие претензии или дополнительные обязательства не могут быть предъявлены. При любых обстоятельствах, компания, не несет ответственности за дополнительные издержки и расходы, связанные с установкой, демонтажем, укладкой и т.д. Рекламации или жалобы не рассматриваются, если они поданы после истечения восьми дней от даты получения товара. После установки любые обнаруженные рекламации или недостатки не рассматриваются, если указанный брак был видимый/или мог быть обнаружен до начала установки. Установка означает подтверждение приема данного товара. Гарантия не распространяется на брак, по причине ненадлежащего применения данного вида товара; нарушения целостности, нормального износа товара, несоответствующего обслуживания и т.д., таким образом, исключая любую ответственность в случае применения агрессивных, абразивных средств и т.д., которые могут повредить поверхность. Срок действия гарантии – 2 года с момента приобретения товара.

9. КОМПЕТЕНТНЫЙ ОРГАН

Для решения всех возможных споров любого рода и происхождения компетентным является исключительно суд города Витербо, исключительно в соответствии с итальянским законодательством, независимо от места подписания договора. Все вышеуказанные общие условия считаются полностью принятыми заказчиком с момента приобретения продукции.

10. продажа в режиме онлайн

Ceramica Cielo запрещает любую продажу своих товаров через интернет-сайты или порталы без предварительного разрешения.

Settembre / Сентябрь 2020

Ceramica Cielo Spa

A.D.

Andrea Parisio

Giuseppe Pezzano

A.D. Progetto Grafico / Графический проект

VZNstudio (Nicola Iannibello e Sonia Mion)

Fotografie / Фотографии:

Davide Lovatti

Fotolito e stampa / Фотолитография и Печать:

TAP Grafiche

Poggibonsi

© Tutti i diritti sono riservati.

Nessuna parte di questo catalogo può essere riprodotta o trasmessa in qualsiasi forma o con qualsiasi mezzo elettronico, meccanico o altro senza l'autorizzazione scritta dei proprietari dei diritti.

© Все права защищены.

Никакая часть этого каталога не может быть воспроизведена или передана в любой форме или любыми электронными, механическими или другими средствами без письменного разрешения правообладателя.