

CATALOGO 10.0



hatria

CATALOGO 10.0

BAHIA_13	20
NEXT	38
BIANCA	46
FUSION	54
BEAT	66
LE FIABE	72
HAPPY HOUR SLIM	88
HAPPY HOUR	108
PENCIL / VALLEY	116
AREA	122
CANALGRANDE	128
GRANDANGOLO	134
NIDO	142
Piatti Doccia in ceramica	148
PETRA_H3 Ardesia	150
LIF H3	162
Sistemi per l'Architettura / Grandi Classici	168
ABITO	170
G-FULL	176
YOU & ME	182
SCULTURE	186
DOLCEVITA	192
PROGETTO	198
LAVABI SOSPESI / DA MOBILE / DA APPOGGIO	199
LAVABI SOSPESI CON COLONNA O SEMICOLONNA	199
LAVAMANI E SPECIALI	199
LAVABI INCASSO / INCASSO SOTTOPIANO / SEMINCASSO	199
PIATTI DOCCIA	200
VASI E BIDET SOSPESI	200
VASI E BIDET A TERRA	200
VASI E BIDET A TERRA / VASI CON CASSETTA / MONOLITH	201
ORINATOIO	201
AUTONOMY	201
BAGNO 1x1 m	201
SCHEDE TECNICHE	208

PRODUCT INDEX

LAVABI SOSPESI

Wall hung washbasins Haungend waschbecken Lavabos suspendus Lavabos suspendidos Раковина подвесная

BAHIA_13 p. 20



1000x465*



800x465 dx-rt*

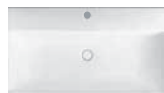

800x465*

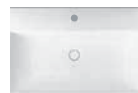

600x465*



500x465*



800x365*



600x365*



500x365*



450x250*

LE FIABE p. 72



1000x485*



810x485*



600x485*

HAPPY HOUR p. 108



480x480

AREA p. 122



1100x350*



700x354*



900x350*



810x450*



600x450

CANALGRANDE p. 128



1000x500*



810x500*



600x500*

GRANDANGOLO p. 134



1500x500*



1300x500*



1300x500 T dx-rh*



1300x500 T sx-lt*



1000x500*



750x500 dx-rh*



750x500 sx-lt*



500x500 dx-rt*



500x500 sx-lt*

* *Anche da mobile* Also for furniture Auch dafür element Aussi pour meubles Tambien mueble Также для мебель

PRODUCT INDEX

LAVABI SOSPESI

Wall hung washbasins Haungend waschbecken Lavabos suspendus Lavabos suspendidos Раковина подвесная

NIDO p. 142



680x480

620x470

560x445

ABITO p. 170



1000x555

G-FULL p. 176



400x480*

YOU & ME p. 182



703x445

460x460 dx-rh

460x460 sx-lt

SCULTURE p. 186



1100x585

770x585

650x585

DOLCEVITA p. 192



1000x550*

750x550*

750x575

700x550

* *Anche da mobile* Also for furniture Auch dafür element Aussi pour meubles Tambien mueble Также для мебель

PRODUCT INDEX

LAVABI D'APPOGGIO

Surface-mounted washbasins Aufsatz washbecken Lavabos a poser Lavabos de apoyo Раковина накладная

BAHIA_13 p. 20



1000x465*



800x465 dx-rt*



800x465*



600x465*



500x465*



800x365*



600x365*



500x365*



450x250*

HAPPY HOUR p. 108



475x475



470x470



440x440



480x480



398x398



500x380



550x405



700x400

HAPPY HOUR SLIM p. 88



250x250



400x400



440x440



500x380



550x380

GRANDANGOLO p. 134



750x500 dx-rh*



750x500 sx-lt*



500x500 dx-rh*



500x500 sx-lt*

PENCIL p. 116



550x380



400x400

VALLEY p. 116



600x400

AREA p. 122



900x350



1000x352



800x350

ABITO p. 170



580x450

NIDO p. 142



680x480



620x470



560x445



750x370

G-FULL p. 176



400x480

YOU & ME p. 182



703x445

SCULTURE p. 186



690x525



520x520

* Anche da mobile Also for furniture Auch dafür element Aussi pour meubles Tambien mueble Также для мебель

PRODUCT INDEX

LAVABI DA INCASSO SOPRAPIANO

Built in washbasins on the countertop *Einbauwaschbecken Lavabos a recouvrement Lavabos encastré sobre encimera Раковина встраиваемая сверху*

DOLCEVITA p. 192



650x480

LAVABI DA INCASSO SOTTOPIANO

Built in undercounter washbasins *Einbauwaschbecken unter der flache Lavabos a recouvrement sous plan Lavabos encastré bajo encimera Раковина встраиваемая снизу*

BAHIA_13 p. 20



500x380

HAPPY HOUR p. 108



440x440



500x380

LAVABI SEMINCASSO

Half built in washbasins *Halbeinbau Lavabos semi encastré Lavabos semi encastré Полуистраиваемая раковина*

HAPPY HOUR p. 108



480x480

PIATTI DOCCIA

Shower Trays *Duschwannen Receveurs de douche Platos de ducha Душевые поддоны*

PETRA_H3 Ardesia Ceramic p. 150



1400x800



1200x800



1000x800



1400x700



1200x700



1000x700



SU MISURA / CUSTOMIZED

LIF H3 Ceramic p. 162



1400x800



1200x800



1000x800



800x800



1400x700



1200x700



1000x700



900x700

VASCHE FREESTANDING

Bathtub *Badewannen Baignoires Bañeras Ванны*



1700x780x600mm



1700x740x590mm

PRODUCT INDEX

VASI E BIDET SOSPESI

Wall-hung WCs and bidets Hängeklosetts und -bidets Cuvettes et bidets suspendus Inodoros y bidés suspendidos Унитазы и биде подвесные

NEXT p. 38

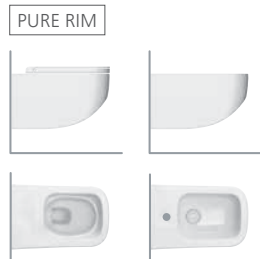

360x560

BIANCA p. 46



360x520

BEAT p. 66



360x520

LE FIABE p. 72



365x560 LE FIABE

365x500 LE FIABE 50

FUSION p. 54



355x540
FUSION



355x485
FUSION COMPACT



355x530
FUSION Q



350x480
FUSION 48

ABITO p. 170



355x560

NIDO p. 142



365x548

SCULTURE p. 186



400x600

VASI E BIDET A TERRA

Floor-mounted WCs and bidets Standklosetts und -bidets Cuvettes et bidets au sol Inodoros y bidés de suelo Напольные унитазы и биде

NEXT p. 38



360x560

BIANCA p. 46



360x520

BEAT p. 66



360x520

355x655x370

PRODUCT INDEX

VASI E BIDET A TERRA

Floor-mounted WCs and bidets Standklosetts und -bidets Cuvettes et bidets au sol Inodoros y bidés de suelo Напольные унитазаы и биде

FUSION p. 54

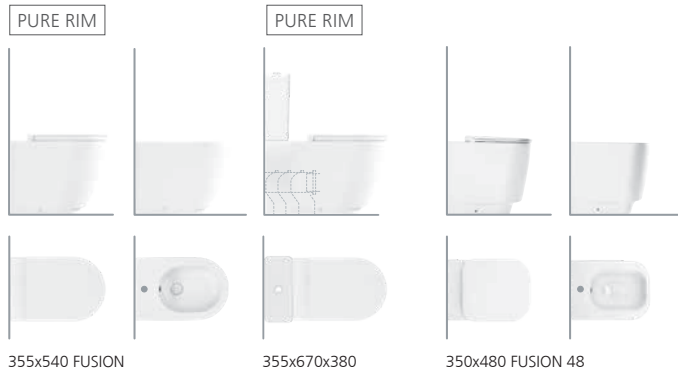

LE FIABE p. 72



NIDO p. 142



SCULTURE p. 186



YOU & ME p. 182



DOLCEVITA p. 192



Hatria, azienda presente sul mercato dagli anni '70, è specializzata nella produzione di sanitari in ceramica di forme e tipologie diverse, dal design innovativo e rigorosamente Made in Italy. L'utilizzo di materie prime purissime, una prototipazione accurata e rigorosa, la gestione di tutte le fasi del processo produttivo, sono supportate da una solida tradizione ceramica, da un "saper fare" che nel tempo si è affiancato a sempre più sofisticate tecnologie.

L'avanzatissimo impianto di produzione automatico sito a Teramo (Italy), base per lo sviluppo di una gamma completa di prodotti che rispondono alle rinnovate esigenze del bagno contemporaneo.

Hatria has been operating since the 1970s and specialises in the production of various types and sizes of ceramic bathroom fittings, with an innovative, 100% Italian design and craftsmanship. The use of extra-pure raw materials, a painstaking, rigorous prototyping process and the management of all stages of the production process are supported by a solid ceramic tradition and craftsmanship skills that over the years have been aided by increasingly sophisticated technologies. The cutting-edge automated production plant located in Teramo (Italy) is the base for the development of a complete range of products able to meet the evolving needs of the contemporary bathroom.

Hatria ist seit den 70er Jahren auf dem Markt präsent und auf die Herstellung von Sanitärkeramik in verschiedenen Formen und Typen, mit innovativem Design und aus strikt italienischer Herstellung, spezialisiert. Die Verwendung von reinsten Rohstoffen, ein akkurates und rigoroses Prototyping, die Kontrolle aller Phasen des Produktionsprozesses, werden von einer soliden Erfahrung im Bereich der Keramik unterstützt, von einem „Know-how“, das im Laufe der Zeit mit immer ausgefeilteren Technologien kombiniert wurde. In der hochmodernen automatisierten Produktionsstätte in Teramo (Italien) wird eine komplette Produktpalette entwickelt, die den gewachsenen Anforderungen an das moderne Bad gerecht wird.

L'entreprise Hatria, présente sur le marché depuis les années 70, est spécialisée dans la production de sanitaires en céramique de formes et types différents, au design innovant, rigoureusement fabriqués en Italie. L'utilisation de matières premières d'une grande pureté, la conception de prototypes soignés dans les moindres détails, la gestion de toutes les phases du processus de production, sont soutenues par une solide tradition céramique. Un savoir-faire qui, au fil du temps, a été associé à des technologies toujours plus avancées. Le site de production automatisé et ultra moderne de Teramo (Italie) permet le développement d'une gamme complète de produits qui répondent aux nouvelles exigences de la salle de bain contemporaine.

Hatria, empresa presente en el mercado desde los años 70, está especializada en la producción de artículos sanitarios de cerámica de diferentes formas y tipos, con un diseño innovador y estrictamente Made in Italy. El uso de materias primas puras, un prototipado preciso y correcto, la gestión de todas las fases del proceso de producción, están respaldadas por una sólida tradición cerámica, por un "know-how" que con el tiempo se ha combinado con tecnologías cada vez más sofisticadas. La avanzada planta de producción automática sita en Teramo (Italia) es la base para el desarrollo de una gama completa de productos que responden a las necesidades renovadas de los baños contemporáneos.

Компания Hatria, присутствующая на рынке с 70-х годов, специализируется на производстве многообразных типов и форм фаянсовой сантехники с инновационным дизайном, изготовление которой осуществляется полностью в Италии. Применение высококачественного сырья, тщательная разработка прототипов, управление всеми этапами производственного процесса дополняются большим опытом и знанием секретов производства с использованием все более совершенной технологии. В Терамо (Италия) находится передовое автоматизированное производство, позволяющее разрабатывать и выпускать полный ассортимент продукции, отвечающей новым требованиям современной ванной комнаты.



TRADIZIONE MADE IN ITALY E AVANGUARDIA TECNOLOGICA

Ceramic tradition made in Italy and leading-edge technology
keramiktradition aus Italien und fortschrittliche Technologie
tradition céramique made in Italy et technologie d'avant-garde
Tradición cerámica made in Italy y tecnología de vanguardia
Традиции керамики «made in Italy» и передовые технологии



Hatria opera in una direzione sostenibile attraverso la riduzione delle fonti energetiche in tutte le fasi del processo produttivo e l'eliminazione dell'impiego di energia per il riscaldamento, insieme a nuove soluzioni che permettono un risparmio nel consumo d'acqua durante l'utilizzo del sanitario. La certificazione del Sistema Qualità Hatria da parte del Certiquality-Certichim, secondo la norma UNI-EN-ISO 9001:2008, è un'ulteriore passo volto a garantire la massima performance dei nostri prodotti. Funzionalità e semplicità d'uso vanno di pari passo con la ricerca di un design raffinato firmato da designers internazionali quali Francesco Lucchese, Dal Lago Associati, Antonio Bullo, Nilo Gioacchini, Federico Sandri e Daniel Debiassi, Mario Alessiani.

Hatria places the accent on eco-sustainable production, by reducing the energy used at all stages of the process and eliminating the use of energy for heating, as well as adopting new solutions to save on the water used by the bathroom fittings. The certification of the Hatria Quality System on the part of Certiquality-Certichim, in accordance with the UNI-EN-ISO 9001:2008 standard, is a further step towards guaranteeing top product performance. Practical and user-friendly, with a sophisticated design by international names such as Francesco Lucchese, Dal Lago Associati, Antonio Bullo, Nilo Gioacchini, Federico Sandri and Daniel Debiassi, Mario Alessiani.

Für Hatria ist Nachhaltigkeit ein wichtiges Anliegen, erreicht wird dies durch Energieeinsparung auf allen Stufen des Produktionsprozesses, für die Heizung wird keine Energie verbraucht und es werden neue Lösungen entwickelt, die Einsparungen beim Wasserverbrauch bei der Nutzung von Sanitärtechnik im Bad ermöglichen. Die Zertifizierung des Qualitätsmanagementsystems von Hatria durch Certiquality-Certichim gemäß Norm UNI-EN-ISO 9001:2008 ist ein weiterer Schritt, um zu garantieren, dass unsere Produkte die beste Leistung bieten. Funktionalität und Einfachheit der Bedienung gehen Hand in Hand mit der Entwicklung eines raffinierten Designs, das von internationalen Designern wie Francesco Lucchese, Dal Lago Associati, Antonio Bullo, Nilo Gioacchini, Federico Sandri und Daniel Debiassi sowie Mario Alessiani gestaltet wurde.

Hatria a adopté des principes de durabilité à travers la réduction de la consommation d'énergie dans chaque phase du processus de production, l'élimination de l'utilisation d'énergie pour le chauffage et de nouvelles solutions d'économie d'eau dans les sanitaires. La certification du Système Qualité de conformité à la norme UNI-EN-ISO 9001:2008, que le Certiquality-Certichim a remise à Hatria, est un gage supplémentaire de l'excellence de nos produits. Fonctionnalité et simplicité d'utilisation vont de pair avec la recherche d'un design raffiné signé par des designers de renommée internationale tels que Francesco Lucchese, Dal Lago Associati, Antonio Bullo, Nilo Gioacchini, Federico Sandri, Daniel Debiassi et Mario Alessiani.

Hatria produce de forma sostenible a través de la reducción de las fuentes de energía en todas las fases del proceso de producción y la eliminación del uso de la energía para la calefacción, junto con nuevas soluciones que permiten un ahorro en el consumo de agua sanitaria. La certificación del Sistema de Calidad de Hatria por parte de Certiquality-Certichim, según la norma UNI-EN-ISO 9001:2008, es otro paso adelante destinado a garantizar el rendimiento máximo de nuestros productos. La funcionalidad y la simplicidad de uso van de la mano con la búsqueda de un diseño refinado firmado por diseñadores de fama internacional como Francesco Lucchese, Dal Lago Associati, Antonio Bullo, Nilo Gioacchini, Federico Sandri y Daniel Debiassi, Mario Alessiani.

Компания Hatria демонстрирует ответственное отношение к окружающей среде посредством сокращения потребления энергии на всех этапах производственного процесса и отказа от использования электроэнергии для отопления, а также посредством внедрения новых решений, позволяющих экономить расход воды при пользовании сантехникой. Сертификация Системы Качества Hatria на соответствие требованиям стандартов UNI-EN-ISO 9001:2008, проведенная Институтом Certiquality-Certichim, – это дальнейший шаг, направленный на обеспечение максимально высокого качества нашей продукции. Функциональность и простота дополняются разработкой изысканного дизайна с участием таких известных дизайнеров, как Франческо Луккеше, студии Dal Lago Associati, Антонио Булло, Нило Джоаккини, Федерико Сандри и Даниэла Дебиаси, а также Марио Алессиани.



QUALITÀ SOSTENIBILE DAL DESIGN CONTEMPORANEO

Sustainable quality from contemporary design
Nachhaltige Qualität aus zeitgenössischem Design
La qualité durable du design contemporain
Calidad sostenible del diseño contemporáneo
Устойчивое качество от современного дизайна



I nuovi vasi rimless NEXT, BIANCA, FUSION, LE FIABE, BEAT di Hatria grazie al sistema di risciacquo con bordo a vista, utilizzando soltanto una piccola quantità d'acqua, non presentano zone di deposito sporco e formazione di batteri. La pulizia del sanitario risulta così estremamente semplice e veloce.

Realizzati secondo un concetto innovativo del sistema di scarico, per facilitare le operazioni di pulizia e manutenzione, questi vasi sospesi in ceramica senza brida mantengono comunque invariate le caratteristiche di installazione dei tradizionali vasi. Lo scarico ed una perfetta pulizia sono garantiti con soli 4,5/3 litri d'acqua.

The new Hatria rimless WCs NEXT, BIANCA, FUSION, LE FIABE, BEAT flushing systems come with visible edges and use only a small amount of water, leaving no space for dirt and bacteria to form. This makes it extremely quick and easy to clean. Designed with an innovative flushing system that facilitates cleaning and maintenance, these ceramic wall hung rimless WCs are in any case installed in the same way as conventional WCs. Flushing and perfect cleaning are assured with just 4.5/3 litres of water.

Die neuen Klosetts rimless NEXT, BIANCA, FUSION, LE FIABE, BEAT von Hatria benötigen dank des Spülsystems mit sichtbarem Rand nur eine geringe Wassermenge, lagern keinen Schmutz ab und fördern die Bakterienbildung nicht. Die Reinigung der Sanitäranlage ist daher extrem einfach und schnell. Diese nach einem innovativen Spülanlagenkonzept, das die Reinigung und Wartung erleichtert, produzierten spülrandlosen wandhängenden Klosetts aus Keramik behalten in jedem Fall die Installationseigenschaften von traditionellen Klosetts bei. Die Spülung und eine perfekte Reinigung werden mit nur 4,5/3 Litern Wasser gewährleistet.

Grâce au système de rinçage à bride ouverte qui ne consomme qu'un petit volume d'eau, dans les nouvelles cuvettes rimless Hatria NEXT, BIANCA, FUSION, LE FIABE, BEAT, les salissures ne forment plus de dépôt, de sorte que les bactéries ne peuvent plus s'y loger. La cuvette est ainsi plus facile et plus rapide à nettoyer. Dotées de cette technique de rinçage innovante qui facilite les opérations de nettoyage et d'entretien, ces cuvettes suspendues sans bride s'installent exactement comme des cuvettes traditionnelles. L'efficacité du rinçage et une propreté parfaite sont assurées avec 4,5/3 litres d'eau seulement.

Gracias al sistema de lavado con borde accesible, los nuevos inodoros rimless NEXT, BIANCA, FUSION, LE FIABE, BEAT de Hatria no presentan zonas de depósito de suciedad ni formación de bacterias con solo usarse un poco de agua. La limpieza del inodoro resulta por tanto extremadamente simple y rápida. Hechos según un concepto innovador del conducto de desagüe, para facilitar las operaciones de limpieza y mantenimiento, estos inodoros suspendidos en cerámica sin canal de lavado mantienen igualmente todas las características de instalación de los inodoros tradicionales. El desagüe y una perfecta limpieza se garantizan con solo 4,5/3 litros de agua.

Новые унитазы rimless NEXT, BIANCA, FUSION, LE FIABE, BEAT производства Hatria, благодаря системе ополаскивания с открытым бортиком, используют минимальное количество воды и препятствуют образованию грязных отложений и формированию бактерий. Уборка такой сантехники становится исключительно простой и быстрой. Изготовленные по инновационной концепции системы слива, что существенно облегчает их очистку и содержание, эти керамические подвесные унитазы без бортика сохраняют неизменными монтажные характеристики традиционных унитазов. Слив и абсолютная чистота обеспечиваются всего лишь 4,5/3 литрами воды.



PURE RIM® PIÙ IGIENE, MENO ACQUA, ZERO BATTERI

More hygiene, less water, zero bacteria
Mehr Hygiene, weniger Wasser, Null Bakterien
Hygiène optimale, moins d'eau consommée, zéro bactérie
Más higiene, menos agua, cero bacterias
Больше гигиены, меньше воды, ноль бактерий



NEXT
4,5 lt VASO SOSPESO
wall hung wc
4,5 lt VASO FILO MURO
back to wall wc



BIANCA
4,5 lt VASO SOSPESO
wall hung wc
4,5 lt VASO FILO MURO
back to wall wc



FUSION
4,5 lt VASO SOSPESO
wall hung wc
4,5 lt VASO FILO MURO
back to wall wc



LE FIABE
4,5 lt VASO SOSPESO
wall hung wc
4,5 lt VASO FILO MURO
back to wall wc
VASO MONOBLOCCO
coupled wc



BEAT
4,5 lt VASO SOSPESO
wall hung wc
4,5 lt VASO FILO MURO
back to wall wc
VASO MONOBLOCCO
coupled wc

FUSION COMPACT
4,5 lt VASO SOSPESO
wall hung wc





Alchemy è un innovativo e tecnologico trattamento delle superfici ceramiche che dona ai sanitari brillantezza unica, massima resistenza ed inattaccabilità. Pensato per garantire igiene e durata nel tempo, Alchemy si associa a nuove forme dal design esclusivo, rese possibili da un impasto di proprietà esclusiva Hatria, che coniuga un alto valore estetico a un significativo rispetto per l'ambiente. Alchemy prende forma e si completa grazie allo studio di un impasto speciale, che consente un design dagli spessori sottilissimi. L'evoluzione di un design contemporaneo, elegante e ricercato unito comunque ad un'inalterata resistenza della ceramica, si traduce nella nuova collezione di lavabi Happy Hour Slim. Alchemy allarga la sua proposta anche alla collezione di sanitari Fusion. Happy Hour Slim e Fusion, un equilibrio perfetto di forme e contenuti.

Alchemy is an innovative, high-tech treatment for finishing ceramic surfaces that gives sanitary fixtures a unique shine and unbeatable toughness, with resistance to microbes and deposits. Conceived to guarantee hygiene and durability, Alchemy combines with new, exclusively styled forms made possible by a Hatria proprietary body mix, which delivers outstanding aesthetic values together with significant environmental benefits. Alchemy takes shape and is completed thanks to the development of a special body mix, allowing the slenderest of designs. The evolution of contemporary, elegant, sophisticated design without any reduction in the strength of the ceramic material gives us the new Happy Hour Slim collection of washbasins. Alchemy extends its reach to include the Fusion sanitary fixture collection. Happy Hour Slim and Fusion, the perfect balance between forms and contents.

Alchemy ist eine innovative Veredelung keramischer Oberflächen, die den Sanitärartikeln einzigartige Brillanz sowie höchste Beständigkeit und Widerstandsfähigkeit verleiht. Konzipiert für Hygiene und Langlebigkeit, kommt Alchemy in einer neuen, geschmackvollen Formensprache zum Ausdruck. Dies ist der exklusiven Keramikmasse von Hatria zu verdanken, die hohe Ansprüche in Bezug auf Ästhetik und Nachhaltigkeit erfüllt. Dank der Entwicklung einer besonderen Keramikmasse, die extrem dünne Wandstärken ermöglicht, zeigt sich Alchemy in vollendeter Form. Das moderne Design von formvollendeter Eleganz und die dauerhafte Beständigkeit der Keramik sind die überzeugenden Merkmale der neuen Waschtisch-Kollektion Happy Hour Slim. Alchemy erstreckt sich auch auf die Sanitärkollektion Fusion. Happy Hour Slim und Fusion, eine perfekte Balance aus Formvollendung und Funktionalität.

Alchemy est un tout nouveau traitement révolutionnaire pour les surfaces céramiques. Avec lui, les sanitaires brillent d'un éclat unique et ils garantissent une solidité maximale et une résistance totale. Mis au point pour garantir hygiène et durabilité, Alchemy épouse des formes nouvelles et exclusives, pétries à partir d'une pâte qui est la propriété exclusive de Hatria, en mesure de conjuguer esthétique supérieure et respect profond pour l'environnement. Alchemy prend corps et se complète par la mise au point d'une pâte spéciale qui permet d'élaborer des formes extrêmement fines. La nouvelle collection de lavabos Happy Hour Slim résume l'évolution d'un design contemporain, élégant et raffiné, auquel s'ajoute la résistance exceptionnelle de la céramique. Alchemy s'applique aussi à la collection de sanitaires Fusion. Happy Hour Slim et Fusion, un parfait équilibre entre formes et contenus.

Alchemy es un tratamiento de las superficies cerámicas innovador y tecnológico que confiere un brillo único a los sanitarios, así como máxima resistencia e invulnerabilidad. Pensado para garantizar higiene y durabilidad, Alchemy se asocia a nuevas formas de diseño exclusivo, hechas posibles gracias a una masa, propiedad exclusiva de Hatria, que conjuga un alto valor estético con un significativo respeto medioambiental. Alchemy toma forma y se completa gracias al estudio de una pasta especial que permite un diseño de grosores muy reducidos. La evolución de un diseño contemporáneo, elegante y sofisticado, sumado a la inalterada resistencia de la cerámica, se traduce en la nueva colección de lavabos Happy Hour Slim. Alchemy amplía su propuesta a la colección de sanitarios Fusion. Happy Hour Slim y Fusion, un perfecto equilibrio de formas y contenidos.

Alchemy - это инновационная технологическая обработка керамических поверхностей, наделяющая сантехнику уникальным блеском, максимальной прочностью и стойкостью. Обработка Alchemy была создана для обеспечения гигиены и долговечности. Она сочетается с новыми эксклюзивными дизайнерскими формами, полученными благодаря смеси, являющейся эксклюзивной разработкой компании Hatria и объединяющей престижную эстетику с высоким уважением к природе. Alchemy приобретает форму и пополняется разработкой специальной смеси для дизайна моделей с очень тонкими стенками. Эволюция современного элегантного и изысканного дизайна в сочетании с прочностью и неизменностью керамики заложена в основу новой коллекции умывальников Happy Hour Slim. Alchemy расширяет свою сферу применения, включая также коллекцию сантехники Fusion. Happy Hour Slim и Fusion - отличное равновесие форм и содержания.

ALCHEMY

L'ESPRESSIONE DELLO SMALTO, LA RICERCATEZZA DEL DESIGN

Expressive glaze, sophisticated design
Die Ausdruckskraft der Glasur, die Finesse des Designs
L'expression de l'émail, la sophistication du design
La expresión del esmalte, la sofisticación del diseño
Выразительность глазури, изысканность дизайна



**ANTIBATTERICO**

ANTIBACTERIAL / ANTIBAKTERIELL /
ANTIBACTÉRIEN / ANTIBACTERIANO /
АНТИБАКТЕРИАЛЬНОСТЬ

**ANTICALCARE**

ANTI-LIMESCALE / KALKABWEISEND /
ANTICALCAIRE / ANTICAL / ЗАЩИТА
ОТ ИЗВЕСТКОВОГО НАЛЕТА

**INALTERABILE**

TIMELESS / BESTÄNDIG / INALTÉRABLE /
INALTERABLE / НЕИЗМЕННОСТЬ

**IDROFUGO**

WATER-REPELLENT / WASSERABWEISEND /
ÉTANCHE À L'EAU / IMPERMEABLE /
ВОДООТТАЛКИВАЕМОСТЬ

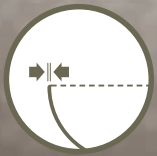
**BORDO ULTRASOTTILE**

ULTRASLIM EDGE / EXTRADÜNNE KANTE /
BORD ULTRA FIN / BORDE ULTRAFINO /
СВЕРХТОНКИЕ СТЕНКИ

**NUOVA GAMMA COLORE**

NEW COLOUR RANGE / NEUE FARBPALETTE /
NOUVELLE PALETTE DE COULEURS /
NUEVA GAMA CROMÁTICA /
НОВАЯ ЦВЕТОВАЯ ГАММА

Il nuovo smalto di base, che aiuta a isolare la superficie da microbi e batteri, viene applicato all'intera gamma prodotti di Hatria, migliorandone la qualità e ponendo attenzione all'esigenza sempre più elevata in materia di prevenzione e salute, con la garanzia di una maggiore igiene e sicurezza all'interno di ogni ambiente bagno.

PIU' IGIENE, QUALITÀ E PREVENZIONE

The new base glaze, which helps keep microbes and bacteria away from the surface, is applied to the entire Hatria product range, improving quality and placing the accent on the increasing importance of prevention and safeguarding health, guaranteeing better hygiene and safety in every bathroom.

BETTER HYGIENE, QUALITY AND PREVENTION

Der neue Basislack, der die Oberfläche gegen Mikroben und Bakterien schützt, wird jetzt für die gesamte Produktpalette von Hatria verwendet, dadurch wird die Qualität verbessert und dem immer größer werdenden Bedürfnis nach Prävention und Gesundheit besondere Beachtung geschenkt, mit der Garantie für mehr Hygiene und Sicherheit in jedem Badezimmer.

MEHR HYGIENE, QUALITÄT UND PRÄVENTION

Le nouvel émail de base, qui contribue à protéger la surface des microbes et des bactéries, est appliqué sur l'ensemble de la gamme des produits Hatria. Il améliore leur qualité et répond aux exigences toujours plus élevées en matière de prévention et de santé, avec la garantie d'une hygiène et d'une sécurité accrues à l'intérieur de chaque salle de bain.

PLUS D'HYGIÈNE, PLUS DE QUALITÉ ET PLUS DE PRÉVENTION

El nuevo esmalte base, que ayuda a aislar la superficie de microbios y bacterias, se aplica a toda la gama de productos de Hatria, mejora la calidad y responde a la necesidad cada vez mayor en materia de prevención y salud, con la garantía de higiene y seguridad en el cuarto de baño.

MÁS HIGIENE, CALIDAD Y PREVENCIÓN

Новая эмалевая грунтовка, позволяющая защитить поверхности от скопления микробов и бактерий, наносится на изделия всего ассортимента сантехники Hatria, что повышает их качество и позволяет соблюдать постоянно растущие требования по профилактике и защите здоровья, обеспечивая более высокий уровень гигиены и безопасности в каждом помещении ванной комнаты.

БОЛЬШЕ ГИГИЕНЫ, КАЧЕСТВА И ПРОФИЛАКТИКИ



SMALTO ANTIBATTERICO

IGIENE E SICUREZZA SU TUTTI I PRODOTTI

Antibacterial glaze_hygiene and safety on all products
Antibakterielle glasur_hygiene und sicherheit bei allen produkten
Émail antibactérien_hygiène et sécurité sur tous les produits
Esmalte antibacteriano_higiene y seguridad en todos los productos
Антибактериальная эмаль_гигиена и безопасность всех изделий



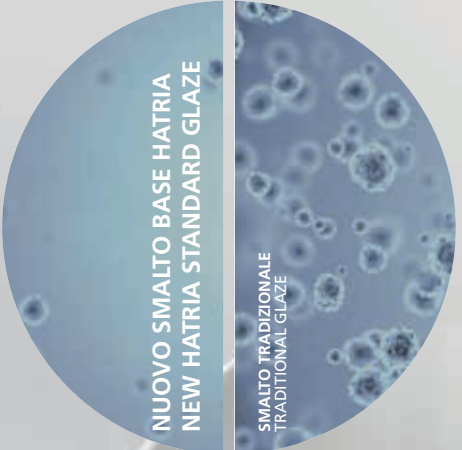

NUOVO SMALTO BASE HATRIA
NEW HATRIA STANDARD GLAZE

SMALTO TRADIZIONALE
TRADITIONAL GLAZE



ALCHEMY

QUALITÀ ESCLUSIVE

EXCLUSIVE FEATURES / EXKLUSIVE VORZÜGE / DES QUALITÉS EXCLUSIVES /
CUALIDADES EXCLUSIVAS / ЭКСКЛЮЗИВНЫЕ СВОЙСТВА



ANTICALCARE

ANTI-LIMESCALE
KALKABWEISEND
ANTICALCAIRE
ANTICAL
ЗАЩИТА ОТ ИЗВЕСТКОВОГО НАЛЕТА

SUPERFICI SEMPRE BRILLANTI, INATTACCABILI E SEMPLICI DA PULIRE

L'aggiunta di cristallina anticalcare negli smalti dona alla superficie ceramica un effetto brillante e lucente, ineguagliabile. Alchemy garantisce grande resistenza ai depositi e all'adesione di calcare, a vantaggio della pulizia che risulta più semplice ed eco sostenibile.

EASY-CLEAN SURFACES, RESISTANT TO DEPOSITS AND WITH A CONSTANT SHINE

The addition of anti-limescale frit to glazes creates a uniquely bright, shiny ceramic surface. Alchemy guarantees outstanding resistance to limescale and other deposits, making cleaning easier and more environment-friendly.

IMMER BRILLANTE, BESTÄNDIGE UND REINIGUNGSFREUNDLICHE OBERFLÄCHEN

Der Zusatz von kalkabweisendem Kristallin in den Glasuren verleiht der keramischen Oberfläche eine einzigartige Brillanz. Alchemy gewährleistet eine hohe Beständigkeit gegenüber der Anhaftung und Ablagerung von Kalk, was den der Reinigungsaufwand mindert – zum Schutz der Umwelt.

DES SURFACES TOUJOURS BRILLANTES, ULTRA RÉSISTANTES ET SIMPLES À NETTOYER

Une fritte anticalcaire est incorporée à l'émail pour donner à la surface céramique une brillance et un éclat sans pareils. Alchemy protège la surface contre les dépôts et les accumulations de calcaire. Le nettoyage est alors plus simple et plus écologique.

SUPERFICIES SIEMPRE BRILLANTES, INVULNERABLES Y FÁCILES DE LIMPIAR

La añadidura de partículas cristalinas antical a los esmaltes otorga a la superficie cerámica un efecto brillante y luminoso inigualable. Alchemy garantiza una gran resistencia a depósitos e incrustaciones de cal, en beneficio de la limpieza, que de este modo resulta más sencilla y ecosostenible.

ВСЕГДА БЛЕСТЯЩИЕ, СТОЙКИЕ ПОВЕРХНОСТИ, КОТОРЫЕ ЛЕГКО ЧИСТЯТСЯ

Добавка в глазурь прозрачного компонента, защищающего от известкового налета, наделяет керамическую поверхность бесподобным блеском. Alchemy гарантирует большую устойчивость к скоплению и отложению известкового налета, обеспечивая более легкую и экологичную очистку.



INALTERABILE

TIMELESS
BESTÄNDIG
INALTÉRABLE
INALTERABLE
НЕИЗМЕННОСТЬ

MASSIMA RESISTENZA, GARANZIA DI DURATA NEL TEMPO

Tecnologie ricercate ed applicate al prodotto determinano qualità e resistenza. Alchemy offre caratteristiche davvero uniche, le superfici diventano difficili da graffiare o segnare, scalfire o rovinare. Qualsiasi macchia o segno è facilmente ripristinabile. Inalterabile nel tempo.

MAXIMUM STRENGTH, GUARANTEED DURABILITY

Sophisticated technologies applied to the product to ensure its quality and strength. Alchemy offers truly unique characteristics; surfaces become highly resistant to scratches, marks, chips or damage. Any stain or mark can easily be removed. Immune to time.

HÖCHSTE BESTÄNDIGKEIT, GARANTIERTE LANGLEBIGKEIT

Ausgefeilte Technologien sorgen für Qualität und Beständigkeit. Alchemy bietet wirklich einzigartige Eigenschaften, da die Oberflächen unempfindlicher gegen Kratzer, Spuren, Schrammen oder Beschädigungen werden. Flecken oder Spuren lassen sich somit leicht entfernen. Dauerhaft beständig.

UNE RÉSISTANCE MAXIMALE, UNE GARANTIE DE DURABILITÉ

La sophistication des technologies dote le produit d'une grande qualité et d'une grande résistance. Alchemy apporte des caractéristiques vraiment exceptionnelles : les surfaces sont difficiles à érafler, à rayer, à marquer ou à abîmer. Les taches ou traces sont très faciles à éliminer. Inaltérable dans le temps.

MÁXIMA RESISTENCIA, GARANTÍA DE DURABILIDAD

La sofisticada tecnología aplicada al producto determina calidad y resistencia. Alchemy brinda unas características verdaderamente únicas que hacen que las superficies resulten de lo más resistentes a sufrir arañazos, señales y rayas, así como al deterioro. Las manchas o señales se borran fácilmente. Inalterable frente al paso del tiempo.

МАКСИМАЛЬНАЯ ПРОЧНОСТЬ - ГАРАНТИЯ ДОЛГОВЕЧНОСТИ

Передовые технологии, применяемые к продукции, обеспечивают ее качество и прочность. Alchemy предлагает на самом деле уникальные характеристики, благодаря которым поверхности надежно защищены от царапин, отметин, повреждений и порчи. Любое пятно или след можно легко устранить. Неизменность с течением времени.



IDROFUGO

WATER-REPELLENT
WASSERABWEISEND
ÉTANCHE À L'EAU
IMPERMEABLE
ВОДООТТАЛКИВАЕМОСТЬ

PROPRIETÀ AUTOPULENTE, FACILE MANUTENZIONE

Il risultato di questi speciali benefici tecnici avviene anche grazie ad un particolare trattamento idrofugo applicato allo smalto. Alchemy ha un effetto sorprendente sulla superficie, permettendo all'acqua e alle gocce di scivolare più agevolmente, evitandone l'accumulo e il ristagno (effetto loto).

SELF-CLEANING PROPERTIES, EASY CARE

The results of these specific technical benefits are thanks in part to a special water-repellent treatment applied to the glaze. Alchemy has a surprising effect on the surface, enabling water and droplets to slip off it more easily, preventing them from building up or stagnating (lotus effect).

SELBSTREINIGUNG, REINIGUNGSFREUNDLICHKEIT

Diese speziellen technischen Vorzüge werden auch dank einer besonderen Veredelung der Glasur zur Geltung, die der Oberfläche wasserabstoßende Eigenschaften verleiht. Alchemy hat eine verblüffende Wirkung auf die Oberfläche. Das Wasser und die Tropfen können leichter abperlen, wodurch eine ständige Benetzung verhindert wird (Lotuseffekt).

QUALITÉS AUTONETTOYANTES, ENTRETIEN FACILE

Ces avantages techniques particuliers se basent sur le traitement d'étanchéité appliqué à l'émail. Alchemy laisse sur la surface un effet surprenant. L'eau et les gouttes glissent plus facilement, évitant ainsi les accumulations et les stagnations (effet lotus).

PROPIEDADES AUTOLIMPIADORAS, FÁCIL MANTENIMIENTO

El resultado de estas ventajas técnicas se logra asimismo gracias al tratamiento impermeable especial que se le da al esmalte. Alchemy tiene un efecto sorprendente sobre la superficie, permite que el agua y las gotas resbalen más fácilmente, evitando que se acumulen y se estancuen (efecto loto).

САМООЧИЩАЕМОСТЬ, ЛЕГКИЙ УХОД

Эти технические преимущества обеспечены также специальным водоотталкивающим покрытием, которое наносится на глазурь. Alchemy образует удивительный эффект на поверхности: эта обработка обеспечивает более легкое стекание воды и капель, не допуская их скопления и застоя (эффект лотоса).

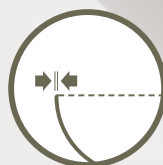

BORDO ULTRASOTTILE

ULTRASLIM EDGE
EXTRADÜNNE KANTE
BORD ULTRA FIN
BORDE ULTRAFINO
СВЕРХТОНКИЕ СТЕНКИ

ELEGANZA E PERFEZIONE, INALTERATA RESISTENZA

Nuova estetica, **solo 5 mm di spessore.**

ELEGANCE AND PERFECTION, WITH NO REDUCTION IN STRENGTH

New look, **just 5 mm thick.**

ELEGANZ UND PERFEKTION, DAUERHAFTE BESTÄNDIGKEIT

Neue Optik, **nur 5 mm Wandstärke.**

ÉLÉGANCE ET PERFECTION, RÉSIDENCE EXCEPTIONNELLE.

Nouvelle esthétique, **seulement 5 mm d'épaisseur.**

ELEGANCIA Y PERFECCIÓN, RESISTENCIA INALTERADA

Nueva estética, **solo 5 mm de grosor.**

ЭЛЕГАНТНОСТЬ И СОВЕРШЕНСТВО, НЕ ИЗМЕНЯЮЩАЯСЯ ПРОЧНОСТЬ

Новая эстетика, **толщина всего лишь в 5 мм.**



ALCHEMY

FANTASIA DI COLORI

AN ARRAY OF COLOURS / FARBPHERANTASIE / FANTASIE DE COULEURS /
FANTASÍA CROMÁTICA / ШИРОКАЯ ПАЛИТРА ЦВЕТОВ



- 01 BIANCO
WHITE
- 25 BIANCO MATT
WHITE MATT
- 12 AVORIO
IVORY
- 29 TABACCO
TOBACCO
- 28 CRETA
CRETE
- 46 SELVA
FOREST
- 26 SABBIA
SAND
- 07 CEMENTO
CEMENT
- 08 ANTRACITE
ANTHRACITE
- 45 CENERE
ASH
- 06 LAVAGNA
BLACKBOARD
- 02 NERO MATT
BLACK MATT



NUOVA GAMMA COLORE
NEW COLOUR RANGE
NEUE FARBPALLETTE
NOUVELLE PALETTE DE COULEURS
NUEVA GAMA CROMÁTICA
НОВАЯ ЦВЕТОВАЯ ГАММА



BAHIA_13

UN NUOVO MONDO DI SOLUZIONI INTEGRATE PER IL TUO BAGNO
A NEW WORLD OF INTEGRATED SOLUTIONS FOR YOUR BATHROOM



FUSION p. 54



FUSION 355x540



FUSION COMPACT 355x485



BIANCA p. 46

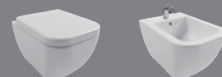

360x520



BEAT p. 66

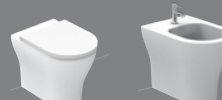
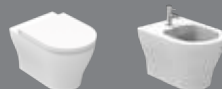

360x520



VASCA OVALE BT_01



1700x780x600



VASCA RETTANGOLARE BT_02



1700x740x590



BAHIA_13



1000x465



800x465 dx-rh



800x465



800x365



600x465



600x365



500x465



500x365

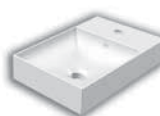

450x250



500x380



01 BIANCO
WHITE



25 BIANCO MATT
WHITE MATT



L'ELEGANZA UNICA E I DETTAGLI ESCLUSIVI DEI LAVABI CERAMICI

The unique elegance and exclusive details of the ceramic washbasins
 Die einzigartige Eleganz und die exklusiven Details der Keramikwaschbecken
 L'élégance unique et les détails exclusifs des lavabos en céramique
 La elegancia única y los detalles exclusivos de los lavabos de cerámica
 Уникальная элегантность и эксклюзивность керамических раковин

L'ineguagliabile design ed eleganza Made in Italy della collezione di lavabi in ceramica, disponibili con finitura lucida o matt, è caratterizzata dai bordi lineari, armonici nelle proporzioni, moderni e sottili, di soli 6 mm di spessore, che garantiscono un'estetica elegante. La gamma è sviluppata fino ai 100 cm di larghezza, e sue due profondità (di 46.5 e 36.5 cm) per adattarsi al meglio a tutti gli ambienti bagno. Inoltre sono unici nel loro genere perché sono disponibili sia con foro troppopieno che senza. L'assenza del foro troppopieno, eliminando interruzioni estetiche conferisce al lavabo un aspetto ancora più armonioso. Lo speciale smalto antibatterico Hatria garantisce ai lavabi la massima igienicità.

The unique elegance and exclusive details of the ceramic washbasins
 The unrivalled Made in Italy design and elegance of the ceramic washbasin, available with glossy or matt finish, is characterized by linear edges, harmonious in proportions, modern and thin, only 6 mm thick, which guarantee an elegant aesthetic. The range is developed up to 100cm in width, and its two depths (of 46.5 and 36.5 cm) are to best adapt to all bathrooms. The washbasins are unique because they are available both with and without overflow hole. The absence of the overflow hole, eliminating aesthetic interruptions, gives the washbasin an even more harmonious appearance. The special Hatria antibacterial glaze guarantees the washbasins maximum hygiene.

Das unvergleichliche Design und die Eleganz der „Made in Italy“ Keramikwaschbecken-Kollektion, die in glänzendem oder mattem Oberflächen erhältlich sind, zeichnen sich durch lineare Kanten aus, die in ihren Maßen harmonisch, modern, dünn, nur 6 mm dick und eine elegante Ästhetik garantieren. Das Sortiment ist bis zu einer Breite von 100 cm und in zwei Tiefen (46,5 und 36,5 cm) erhältlich, um sich an alle Badezimmer anzupassen. Sie sind auch in ihrer Art einzigartig, da sie sowohl mit als auch ohne Überlaufloch verfügbar sind. Das Waschbecken ohne Überlaufloch verleiht ein noch harmonischeres Aussehen. Die spezielle antibakterielle Hatria-Glasur garantiert den Waschbecken maximale Hygiene.

Le design et l'élégance inégalés Made in Italy de la collection de lavabos en céramique, disponibles avec une finition brillante ou mate, se caractérisent par des bords linéaires, harmonieux dans les proportions, modernes et ultra fins, seulement 6 mm d'épaisseur, qui garantissent une esthétique élégante. La gamme est développée jusqu'à 100cm de largeur, et de deux profondeurs (46,5 et 36,5 cm) pour s'adapter au mieux à tous les environnements de salle de bain. Ils sont également uniques en leur genre car ils sont disponibles avec ou sans trou de trop-plein. L'absence de trou de trop-plein, éliminant les interruptions esthétiques, donne au lavabo un aspect encore plus harmonieux. L'émail antibactérien spécial Hatria garantit une hygiène maximale des lavabos.

El inigualable diseño "Made in Italy" y la elegancia del lavabo de cerámica, disponible en acabado brillante o mate, caracterizado por cantos lineales, armoniosos en proporciones, moderno y fino, de tan solo 6 mm de espesor, que garantizan una estética elegante. La gama se desarrolla hasta los 100cm de ancho, y sus dos profundidades (de 46,5 y 36,5 cm) son para adaptarse mejor a todos los baños. Los lavabos son únicos porque están disponibles con y sin rebosadero. La ausencia del rebosadero, eliminando las interrupciones estéticas, confiere al lavabo un aspecto aún más armonioso. El esmalte especial antibacteriano Hatria garantiza la máxima higiene de los lavabos.

Непревзойденный дизайн и элегантность коллекции керамических умывальников «Made in Italy», доступные в глянцевой или матовой отделке, характеризуются прямыми линиями, гармоничные пропорции, современный дизайн с тонкими бортами, толщиной всего 6 мм, которые гарантируют элегантный эстетический вид. Диапазон ширины составляет до 100 см и две глубины (46,5 и 36,5 см), чтобы наилучшим образом адаптироваться к любому варианту ванной комнаты. Они также уникальны в своем роде, потому что доступны как с переливным отверстием, так и без него. Отсутствие переливного отверстия, убирает эстетические недостатки и придает раковине еще более гармоничный вид. Специальная антибактериальная эмаль Hatria гарантирует максимальную гигиену умывальника.

BAHIA_13 UN SISTEMA MODULARE DAL DESIGN MINIMALE E POLIEDRICO

A modular system with a minimal and faceted design
 Ein modulares System mit minimalem und vielseitigem Design
 Un système modulaire au design minimaliste et multiforme
 Un sistema modular con un diseño minimalista y elegante
 Модульная система в стиле минимализм и многогранности

Una ricca gamma di soluzioni tra cui scegliere per colori, finiture e dimensioni, che integra 10 lavabi con mobili coordinati e accessori che rendono possibile la progettazione e l'arredamento della stanza da bagno a misura di ogni esigenza.

A wide range of solutions to choose from colors, finishes and sizes, which integrates 10 washbasins with coordinated furniture and accessories that make it possible to design and furnish the bathroom to suit every need.

Eine reiche Wahl von Lösungen in Bezug auf Farbe, Endbearbeitung und Größen, für 10 verschiedene Waschbecken mit passenden Möbeln und Zubehör ergänzen, die es ermöglichen, das Badezimmer für jeden Bedarf zu entwerfen und einzurichten.

Une large gamme de choix pour les couleurs, les finitions et les dimensions, qui intègre 10 lavabos avec des meubles et accessoires coordonnés qui permettent de concevoir et de meubler la salle de bain pour répondre à tous les besoins.

Una amplia gama de soluciones para elegir entre colores, acabados y medidas, que integra 10 lavabos con muebles y accesorios a juego que permiten diseñar y amueblar el baño a la medida de cada necesidad.

Широкий ассортимент решений, где можно выбрать цвет, отделку, размер, которое включает 10 умывальников с мебелью и аксессуарами, которые позволяют спроектировать любую композицию под необходимые размеры.

L'offerta Bahia_13 è ulteriormente arricchita da strutture contenitive a cassetti, con 2 profondità e modulari, nelle dimensioni dei lavabi e disponibili in 5 colori naturali. I due cassetti del mobile hanno le sponde in metallo verniciato con guide ad estrazione totale e chiusura ammortizzata per garantire un maggior confort nell'utilizzo. Il fondo interno dei cassetti è rivestito con un materiale effetto pelle, in tinta con la struttura interna, che conferisce pregio e praticità al mobile. In aggiunta, una serie di strutture in metallo con comodi ripiani portaoggetti, disponibili sia a terra e che sospese, le barre portasciugamani, sia frontali che laterali, i sifoni dal design raffinato, regolabili in altezza, disponibili nei colori nero matt e cromo lucido e le pilette in ceramica, offrono soluzioni originali e funzionali per arredare ogni ambiente bagno.

Bahia_13 offer is further enriched by cabinets with drawers, with 2 depths and modular, with the sizes of the washbasins and available in 5 natural colors. The two drawers of the cabinet have sides in painted metal, fully extractable guides and soft closing to ensure greater comfort in use. The internal bottom of the drawers is covered with a leather-effect material, matching the internal structure, which gives value and practicality to the cabinet. In addition, a series of metal structures with comfortable storage shelves, available both floor mounted and wall hung, the towel racks, both front and side, the siphons with a refined design, adjustable in height, available in matt black and glossy chrome and the ceramic drains, offer original and functional solutions to furnish any bathroom.

Das Bahia_13-Angebot wird durch Schubladen mit 2 Tiefen und Baukastensystem in der Größe der Waschbecken und in 5 natürlichen Farben ergänzt. Die beiden Schubladen des Schrankes haben die Seiten aus lackiertem Metall mit vollständig herausziehbaren Führungen mit weichem Schließen, um eine Benutzerfreundlichkeit zu gewährleisten. Der Innenboden der Schubladen ist mit einem Material in Lederoptik in der gleichen Farbe wie die Innenstruktur des Schrankes bedeckt, um Wert und Zweckmäßigkeit zu gewährleisten. Darüber hinaus eine Reihe von Metallkonstruktionen mit bequemen Regalbrettern, die sowohl für den Boden als auch wandhängend erhältlich sind. Diese haben Handtuchhalter sowohl vorne als auch an der Seite und die Siphons mit einem raffinierten Design, höhenverstellbar, in mattem Schwarz und glänzendem Chrom verfügbar sind. Die Keramikabläufe bieten originelle und funktionale Lösungen für jedes Badezimmer.

L'offre Bahia_13 est encore enrichie par des structures de rangement avec tiroirs, à 2 profondeurs et modulables, selon la taille des lavabos et disponibles en 5 coloris naturels. Les deux tiroirs du meuble ont des côtés en métal peint avec des glissières entièrement extractibles et une fermeture douce pour assurer un plus grand confort d'utilisation. Le fond intérieur des tiroirs est recouvert d'un matériau effet cuir, de la même couleur que la structure interne, ce qui donne de la valeur et de la praticité au meuble. En outre, une série de structures métalliques avec des étagères de rangement confortables, disponibles à la fois au sol et suspendues, les porte-serviettes, à l'avant et sur les côtés, les siphons au design raffiné, réglables en hauteur, disponibles en noir mat et chrome brillant et les bondes en céramique offrent des solutions originales et fonctionnelles pour aménager n'importe quel environnement de salle de bain.

La oferta Bahia_13 se enriquece aún más con los armarios con cajones, de 2 profundidades y modulares, con las medidas de los lavabos y disponibles en 5 colores naturales. Los dos cajones del mueble tienen laterales en metal pintado, guías totalmente extraíbles y cierre suave para garantizar una mayor comodidad de uso. El fondo interno de los cajones revestido con un material efecto cuero, a juego con la estructura interna, lo que le da valor y practicidad al mueble. Además, una serie de estructuras metálicas con cómodos estantes de almacenaje, disponibles tanto en suelo como en pared, los toalleros, tanto frontales como laterales, los sifones con un refinado diseño, regulables en altura, disponibles en negro mate y cromo brillo y el desagües cerámicos, ofrecen soluciones originales y funcionales para amueblar cualquier baño.

Предложение Bahia_13 дополнено структурами для хранения с ящиками, с 2 глубинами и модульным размером с умывальником и доступными в 5 натуральных цветах. Два ящика шкафа имеют боковые стороны из окрашенного металла с полностью выдвигаемыми направляющими и мягким закрытием для большего комфорта при использовании. Внутреннее дно ящиков покрыто материалом с эффектом кожи того же цвета, что и внутренняя структура, что придает шкафу дороговизну и практичность. Кроме того, серия металлических конструкций с удобными полками для хранения, доступными как напольные, так и на подвесные версии, штанги для полотенец, как передние, так и боковые, сифоны изысканного дизайна, регулируемые по высоте, доступные в матовом черном и глянцево хромировании и керамические накладки на слив предлагают оригинальные и функциональные решения для оформления любой ванной комнаты.



BAHIA_13 ACCESSORI COORDINATI PER UN'OFFERTA REALMENTE INTEGRATA

Coordinated accessories for a truly integrated offer
Koordinierte Zubehöre für ein effektives integriertes Angebot
Accessoires coordonnés pour une offre véritablement intégrée
Accesorios a juego para una oferta verdaderamente integrada
Дополнительные аксессуары для действительно комплексного предложения

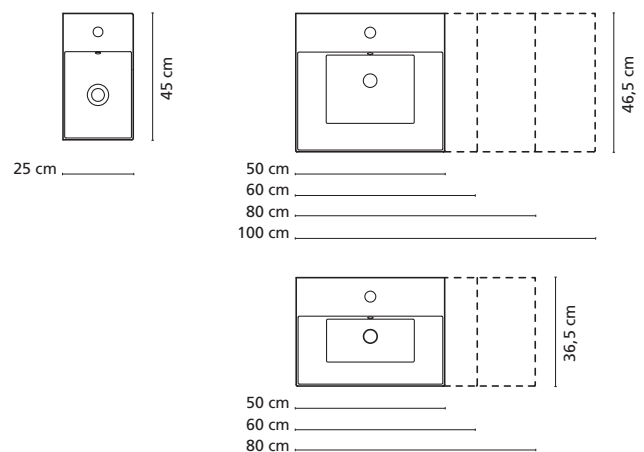

- BIANCO
WHITE
- ROVERE SHERWOOD CHIARO
LIGHT OAK
- ROVERE SHERWOOD CASTANO
CHESTNUT OAK
- ROVERE SHERWOOD SCURO
DARK OAK
- CEMENTO/TORTORA
CEMENT/TORTORA





01

01: LAVABO 100x46,5 CON FORO RUBINETTERIA E FORO TROPPO PIENO, PILETTA IN CERAMICA -
SPECCHIO TONDO Ø60, VASCA OVALE 170x78

01: washbasin 100x46,5 one hole with overflow, ceramic drain, round mirror Ø60, bathtub 170x78



VASCHE CENTROSTANZA Freestanding Bathtubs

Le vasche centrostanza Hatria, dal design moderno ed elegante, sono studiate per conferire alla stanza da bagno una dimensione Wellness, regalando intimità e una sensazione di armonia e relax all'ambiente in cui sono collocate. Le vasche centrostanza, disponibili sia in bianco lucido che matt, sono la soluzione perfetta per chi desidera arredare la stanza da bagno in un modo ricercato e che doni la percezione quotidiana di vivere in uno spazio unico, ispirato al lusso e al prestigio.

The freestanding bathtubs Hatria, with a modern and elegant design, are studied to give the bathroom a Wellness dimension, giving intimacy and a feeling of harmony and relaxation to the environment in which they are located. The freestanding bathtubs, available in both glossy white and matt, are the perfect solution for those who want to furnish the bathroom in a refined way and which gives the daily perception of living in a unique space, inspired by luxury and prestige.

SPECCHIERE Mirrors

Le Specchiere Hatria arricchiscono con un tocco di design e personalità l'offerta per arredare la stanza da bagno, grazie alla varietà di forme disponibili, dal telaio in metallo nero e corda in ecopelle oppure con profilo di soli 4 millimetri filo lucido e retroilluminazione led perimetrale.

The mirrors Hatria enrich with a touch of design and personality the offer for furnishing the bathroom, thanks to the variety of shapes available, from the black metal frame and eco-leather cord or with a profile of only 4 mm with polished edge and perimeter LED backlighting.





03

02: LAVABO 100x46,5 SENZA FORO RUBINETTERIA, SENZA FORO TROPPO PIENO CON PILETTA IN CERAMICA -
MOBILE 100 CEMENTO TORTORA, SPECCHIO RETTANGOLARE 80x70

03: LAVABO 80x46,5 DESTRO CON FORO RUBINETTERIA, CON FORO TROPPO PIENO E PILETTA IN CERAMICA -
MOBILE 80 BIANCO, SPECCHIO RETTANGOLARE 80x70

02: washbasin 100x46,5 without tap hole and overflow, ceramic drain - furniture 100 cemento tortora, rectangular mirror 80x70

03: washbasin 80x46,5 right shelf one hole, with overflow and ceramic drain - furniture 80 white, rectangular mirror 80x70



04

04: LAVABO 60x46,5 CON FORO RUBINETTERIA, FORO TROPPO PIENO CON BORCHIETTA BIANCA E PILETTA IN CERAMICA - MOBILE 60 ROVERE CHIARO, SPECCHIO RETTANGOLARE 60x70

05: LAVABO 80x46,5 BIANCO MATT CON FORO RUBINETTERIA, FORO TROPPO PIENO E PILETTA IN CERAMICA - SPECCHIO TONDO Ø60

06: LAVABO 50x46,5 SENZA FORO RUBINETTERIA, SENZA TROPPO PIENO CON PILETTA IN CERAMICA - PORTA SCIUGAMANI, SPECCHI TONDI Ø80

04: washbasin 60x46,5 one hole, overflow with white cover and ceramic drain - furniture 60 rovere chiaro, rectangular mirror 60x70

05: matt white washbasin 80x46,5 one hole, overflow and ceramic drain - round mirror Ø60

06: washbasin 50x46,5 without tap hole, without overflow, with ceramic drain - towel rack, round mirrors Ø80



05



06



07

07: LAVABO 80x36,5 SENZA FORO RUBINETTERIA, CON FORO TROPPO PIENO - STRUTTURA A TERRA NERO MATT,
VASCA RETTANGOLARE 170x74 BIANCO MATT, SPECCHIO RETTANGOLARE 100x70

07: washbasin 80x36,5 without tap hole, with overflow – black matt metal structure, matt white rectangular bathtub 170x74, rectangular mirror 100x70





08

08: LAVABO 80x36,5 CON FORO RUBINETTERIA, SENZA FORO TROPPO PIENO - STRUTTURA SOSPESA CROMO,
SPECCHIO RETTANGOLARE 80x70

08: washbasin 80x36,5 one hole, without overflow - wall hung chromed metal structure, rectangular mirror 80x70



09

09: LAVABO 50x36,5 CON FORO RUBINETTERIA , FORO TROPPO PIENO CON BORCHIETTA INOX -
SPECCHIO RETTANGOLARE 40x70, PORTASCIUGAMANO LATERALE CROMO

09: washbasin 50x36,5 one hole, overflow and inox drain – rectangular mirror 40x70, side chromed towel rack



10



11

10: LAVABO 60x36,5 BIANCO MATT 3 FORI RUBINETTERIA , CON FORO TROPPO PIENO - MOBILE 60 ROVERE CASTANO,
SPECCHIO TONDO CON CORDA IN ECOPELLE E CORNICE NERA Ø60

11: LAVAMANI 45x25 CON FORO RUBINETTERIA - MOBILE ROVERE SCURO, SPECCHIO RETTANGOLARE 40x70

10: matt white washbasin 60x36,5 three tap holes, overflow – furniture 60 rovere castano, round mirror with faux leather cord and black frame Ø60

11: wand wash 45x25 one hole - furniture rovere scuro, rectangular mirror 40x70



12

12: LAVABI SOTTOPIANO 50x38 CON PILETTA CERAMICA, SPECCHI TONDI Ø60

12: under counter washbasins 50x38 with ceramic drain, round mirror Ø60



NEXT

DIAMO UN TAGLIO AL PASSATO
LET'S TAKE A BREAK WITH THE PAST



Un nuovo sistema di scarico più compatto, che permette al sanitario di essere più slanciato e nascondere lo scarico. Si è agito sulla forma in maniera netta, come a volerne tagliare una parte per far intuire che rispetto al passato è accaduto qualcosa. Il concept di Next, nasce dall'esigenza di raccontare, attraverso il design, un'innovazione tecnica unica nel suo genere, che esalta al massimo il risultato estetico della ceramica. Next, l'esaltazione estetica della ceramica che si manifesta in un incrocio di curve sorprendente. La carenatura è completa e nasconde tutto al suo interno, **il sifone scompare e diventa invisibile.**

A new more compact discharge system makes the sanitaryware more streamlined and allows hiding the discharge. The brand-new shape alludes to the fact that something has changed compared to the past. The concept of Next comes from the need to convey a unique technical innovation through design which celebrates the aesthetic nature of ceramic. Next, an aesthetic celebration of ceramic expressed in a meeting of surprising curves. The fairing is complete and hides everything in its interior, **the siphon disappears and becomes invisible.**

Ein kompakteres neues Spülsystem, dank dessen die sanitäre Anlage schlanker wird und der Abfluss verborgen bleibt. Die Form wurde deutlich abgeändert, als wollte man einen Teil abschneiden, damit man erahnen kann, dass es im Vergleich zur Vergangenheit eine Änderung gegeben hat. Das Konzept von Next entspringt dem Bedürfnis, anhand des Designs über eine in ihrer Art einzigartige technische Innovation zu berichten, die das ästhetische Ergebnis der Keramik optimal zur Geltung bringt. Next, die ästhetische Verherrlichung der Keramik, die sich in Form der Überkreuzung erstaunlicher Kurven offenbart. Die komplette Verkleidung verbirgt alles in ihrem Inneren, **der Siphon verschwindet und ist nicht mehr zu sehen.**

Un nouveau système d'évacuation plus compact qui permet aux sanitaires d'être plus élancés et de dissimuler ledit système. L'intervention a eu lieu sur la forme de manière nette, comme pour en supprimer une partie et laisser présager qu'une modification a été faite par rapport au passé. Le concept de Next naît de l'exigence de raconter, à travers le design, une innovation technique unique en son genre, qui exalte au maximum le résultat esthétique de la céramique. Next, l'exaltation esthétique de la céramique se manifeste en un entrelacement surprenant de courbes. Le carénage est complet et cache tout en son intérieur ; **le siphon disparaît et devient invisible.**

Un nuevo sistema de descarga más compacto que le permite al inodoro ser más fino al esconder la descarga. Se ha intervenido directamente en la forma al cortar una parte como para mostrar que ha habido un cambio con respecto al pasado. El concepto de Next nace de la necesidad de querer expresar a través del diseño una innovación técnica exclusiva que exalta al máximo el resultado estético de la cerámica. Next, la exaltación de la cerámica que se manifiesta en un cruce de curvas sorprendentes. La carenatura es completa y lo esconde todo en su interior; **el sifón desaparece volviéndose invisible.**

Новая более компактная система смыва делает конструкцию унитаза менее громоздкой и позволяет спрятать слив. Форма как бы говорит о том, что у нее хотели отнять часть ее, и что с ней в прошлом что-то произошло. Концепция модели Next рождена желанием рассказать посредством дизайна об уникальном в своем роде техническом новшестве, позволившем максимально подчеркнуть эстетический результат керамики. В модели Next эстетика керамики проявляется в удивительном сочетании изогнутых линий. Обтекаемый корпус полностью все скрывает, **и сливной сифон становится невидимым.**



NEXT ABBIAMO NASCOSTO L'INNOVAZIONE PER ESALTARE LA BELLEZZA

We have hidden its innovation to widespread its beauty
Wir haben diese Innovation versteckt um ihre Schönheit zu steigern
Nous avons dissimulé son innovation pour exalter sa beauté
Nos conciliaciones tecnología para exalter la belleza
Мы скрывали свое новшество возвысить свою красоту





NEXT



BAHIA_13 p. 20



1000x465 800x465 dx-rh 800x465



600x465 500x465



800x365 600x365 500x365



450x250 500x380

ABITO p. 170



1000x555

PENCIL p. 116



550x380



400x400

HAPPY HOUR SLIM p. 88



250x250 400x400 440x440 500x380



550x380

CANALGRANDE p. 128



1000x500 810x500 600x500

NEXT 360x560

PURE RIM



PURE RIM

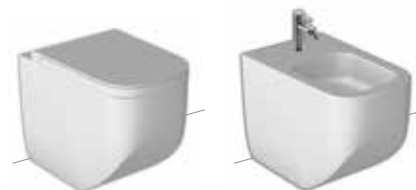

01 BIANCO
WHITE



25 BIANCO MATT
WHITE MATT



08 ANTRACITE
ANTHRACITE



02 NERO MATT
BLACK MATT



01

01: VASO + BIDET SOSPESI ANTRACITE

01: wall hung wc + bidet anthracite



02: VASO PURE RIM + BIDET FILO MURO, LAVABO PENCIL 55
03: VASO PURE RIM + BIDET SOSPESI

*02: back to wall PURE RIM wc + bidet, washbasin PENCIL 55
03: wall hung PURE RIM wc + bidet*



04

04: VASO PURE RIM + BIDET SOSPESI, LAVABO CANALGRANDE 100

04: wall hung PURE RIM wc + bidet, washbasin CANALGRANDE 100



BIANCA

ELEGANTE E CONTEMPORANEA
ELEGANT AND CONTEMPORARY



BAHIA_13 p. 20



1000x465 800x465 dx-rh 800x465



600x465 500x465



800x365 600x365 500x365



450x250 500x380

HAPPY HOUR SLIM p. 88



250x250 400x400 440x440



500x380 550x380

HAPPY HOUR p. 108



475x475 470x470 480x480



500x380 550x405 440x440

BIANCA 360x520

PURE RIM



PURE RIM

TRASLATO



BIANCA 355x655x370



  **01 BIANCO**
WHITE

  **25 BIANCO MATT**
WHITE MATT



01

BIANCO MATT / WHITE MATT**01: VASO SCARICO TRASLATO PURE RIM + BIDET FILO MURO***01: PURE RIM shifted outlet back to wall wc + bidet*



02: VASO + BIDET FILO MURO

02: back to wall wc + bidet



03

03: VASO PURE RIM + BIDET SOSPESI, LAVABO HAPPY HOUR SLIM 11:00s

03: PURE RIM wall hung wc + bidet, washbasin HAPPY HOUR SLIM 11:00s



04

04: VASO + BIDET SOSPESI, LAVABO HAPPY HOUR SLIM 06:00s

04: wall hung wc + bidet, washbasin HAPPY HOUR SLIM 06:00s



05

05: VASO MONOBLOCCO CON CASSETTA

05: coupled wc with cistern



FUSION

FORME CONTINUE PER SPAZI FLESSIBILI
ENDLESS FORMS FOR FLEXIBLE SPACES



Abbinamenti consigliati *Suggested combinations*

BAHIA_13 p. 20

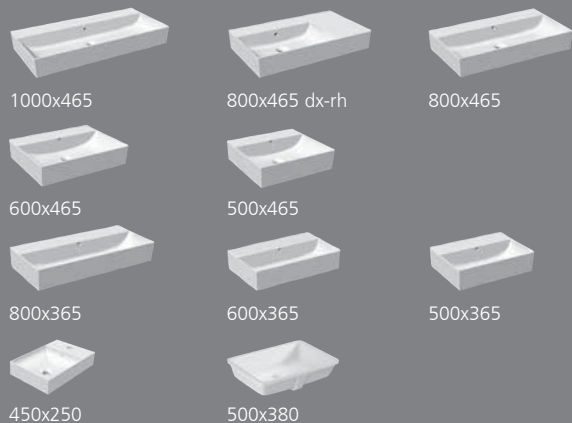

GRANDANGOLO p. 134

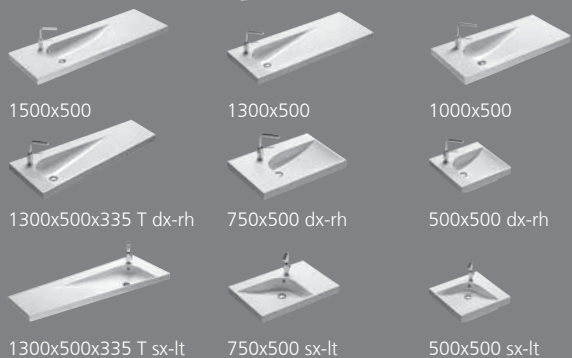

AREA p. 122

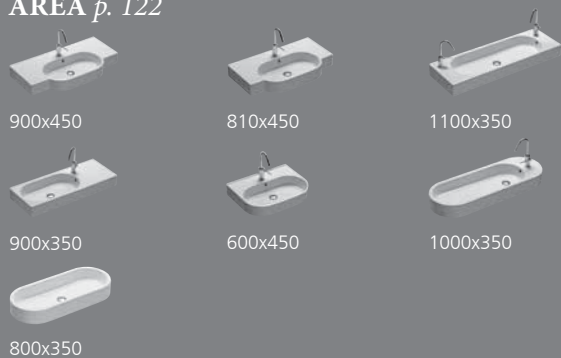

HAPPY HOUR SLIM p. 88



VASCA OVALE BT_01



VASCA RETTANGOLARE BT_02

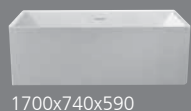

FUSION 355x540

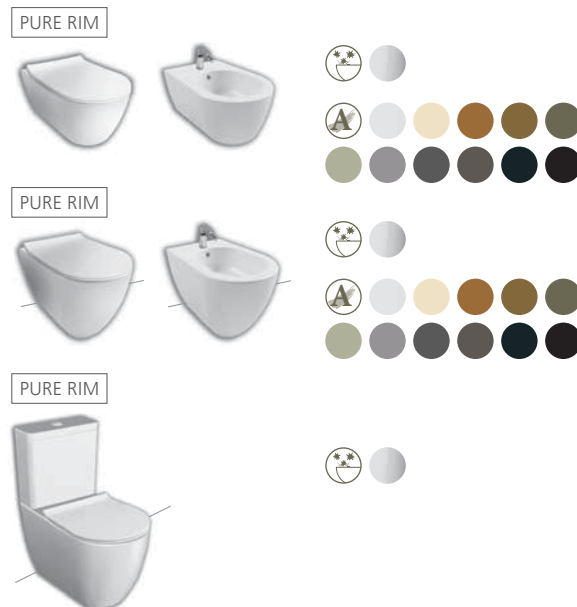

670x380

FUSION COMPACT 355x485



FUSION 48 350x480



FUSION Q 360x530



FUSION ORINATOI 685x325



- | | | | | | |
|--|------------------------------|--|-------------------------------------|--|-----------------------------------|
| | 01 BIANCO
WHITE | | 25 BIANCO MATT
WHITE MATT | | 26 SABBIA
SAND |
| | 12 AVORIO
IVORY | | 07 CEMENTO
CEMENT | | 08 ANTRACITE
ANTHRACITE |
| | 29 TABACCO
TOBACCO | | 45 CENERE
ASH | | 06 LAVAGNA
BLACKBOARD |
| | 28 CRETA
CRETE | | 02 NERO MATT
BLACK MATT | | |
| | 46 SELVA
FOREST | | | | |



PURE RIM



La tecnologia PURE RIM è estesa a tutte le tipologie di vasi Fusion round : sospeso, filo muro, monoblocco filo muro. Anche il nuovo vaso sospeso "Compact", dalle ridottissime dimensioni, è dotato di questa tecnologia.

PURE RIM technology is available for all the models of the Fusion Round series, either wall-hung, back-to-wall or close-coupled. Even the brand-new wall-hung "Compact" is equipped uniquely with this technology.

Alle unsere Modellen von Fusion (HangeWC; Boden und mit Spuhlkasten inbegriffen) sind mit der Technologie PURE RIM ausgestattet. Auch die neue "Compact", mit sehr kleinen Abmessungen.

La technologie PURE RIM est appliquée sur tous les modèles Fusion, sans exception, que ce soit la version suspendue, au sol ou pack-wc. Egalement la nouvelle version suspendue "Compact" est dotée de cette nouvelle technologie.

La tecnología PURE RIM se extiende a todos los tipos de inodoro Fusion redondo: suspendido, a la pared, monobloque a la pared. El nuevo inodoro suspendido "Compact", con sus dimensiones extremadamente reducidas, está equipada con esta tecnología.

Технология PURE RIM едина для всех типов унитаза Fusion round: подвесной, напольный, моноблок. Также новый подвесной унитаз "Compact" с уменьшенными размерами будет с данной технологией.



01

FUSION

01: VASO PURE RIM + BIDET FILO MURO

01: PURE RIM back to wall wc + bidet



02

FUSION**02: VASO PURE RIM + BIDET SOSPESI***02: PURE RIM wall hung wc + bidet*



03



FUSION

03: VASO PURE RIM + BIDET SOSPESI, LIF H3 140x70

03: PURE RIM wall hung wc + bidet, LIF H3 140x70



04

FUSION COMPACT

04: VASO SOSPESO PURE RIM + BIDET

04: PURE RIM wall hung wc + bidet



05

FUSION Q

05: VASO + BIDET SOSPESI

05: wall hung wc + bidet



FUSION

06: ORINATOIO

07: ORINATOIO CON COPERCHIO

06: urinal

07: urinal with cover



08



09

FUSION 48

08: VASO + BIDET FILO MURO

09: VASO + BIDET SOSPESI

08: back to wall wc + bidet

09: wall hung wc + bidet



BEAT

AMBIENTE GIOVANE, AL TUO RITMO
TRENDY ATMOSPHERE, FOLLOWING YOUR RHYTHM



BAHIA_13 p. 20

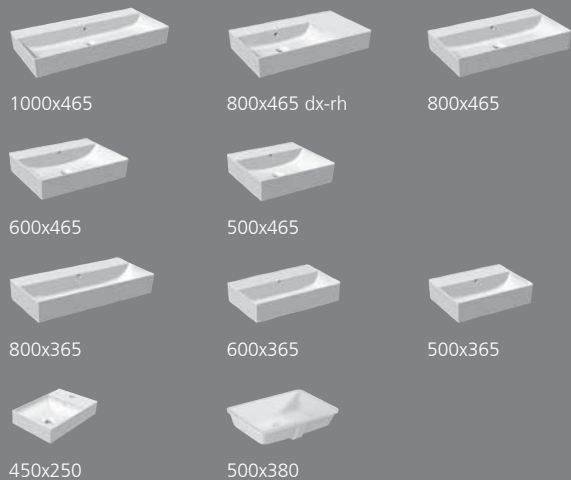

HAPPY HOUR SLIM p. 88

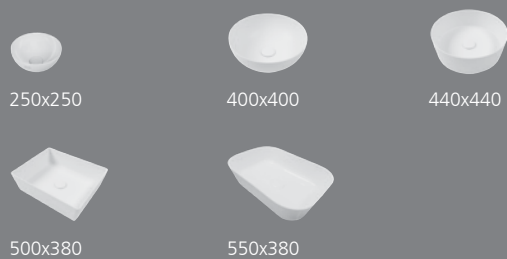

HAPPY HOUR p. 108



VASCA OVALE BT_01



VASCA RETTANGOLARE BT_02



BEAT 360x520





01

01: VASO + BIDET FILO MURO, LAVABO HAPPY HOUR SLIM 18:00s

01: back to wall wc + bidet, washbasin HAPPY HOUR SLIM 18:00s



02

02: VASO + BIDET SOSPESI, LAVABO HAPPY HOUR SLIM 18:00s

02: wall hung wc + bidet, washbasin HAPPY HOUR SLIM 18:00s,



03: VASO + BIDET SOSPESI

03: wall hung wc + bidet



LE FIABE

IMMERGERSI IN UN LUOGO MAGICO CHE LASCIA SPAZIO ALL'IMMAGINAZIONE
LOSE YOURSELF IN A MAGICAL WORLD THAT LEAVES ROOM FOR IMAGINATION



Un'idea di progetto a 360° è alla base della ricerca Hatria, che continuamente si evolve per offrire nuove soluzioni coniugando estetica e funzionalità: il design costruisce la forma intorno a sistemi che migliorano la qualità e le performances del prodotto. **PURE FIX®**, il nuovo fissaggio nascosto per vasi e bidet terra filo muro, presente nell'ultima collezione Hatria Le Fiabe, è l'innovazione che permette di avere finalmente anche per i sanitari terra un risultato esteticamente perfetto e pulito, in quanto privi di alcun fissaggio visibile. In combinazione con il **VASO TRASLATO** e il **BIDET APERTO** nella parte posteriore, ideali nelle ristrutturazioni per adattare impianti esistenti.

A 360° project idea lies at the base of Hatria research, which is evolving all the time to offer new solutions that are both beautiful and functional: design builds the shape around systems conceived to improve product quality and performance. **PURE FIX®**, the new concealed fixing element for back-to-wall WCs and bidets, presented in the latest Hatria collection, "Le Fiabe", is an innovative solution that offers a perfectly attractive, clean solution for back-to-wall bathroom fittings, because there are no visible fixing elements. In combination with the **SHIFTED WC** and the **BIDET OPEN** at the back, it is ideal for renovations, to adapt existing fittings.

Eine Projektidee, die alle Aspekte einbezieht, bildet die Grundlage für die Forschung von Hatria, die sich ständig weiterentwickelt, um neue Lösungen unter Kombination der Ästhetik und der Zweckmäßigkeit zu bieten. Das Design stellt die Form rund um Systeme dar, die die Qualität und die Leistungen des Produkts verbessern. **PURE FIX®**, die neue verborgene Befestigung für an die Wand anliegende Stand-Klosettbecken und -Bidets der neuen Kollektion „Le Fiabe“ von Hatria, ist die Innovation, dank der endlich auch die auf dem Boden stehenden sanitären Anlagen ein perfektes, sauberes ästhetisches Ergebnis ohne sichtbare Befestigungen bieten können. In Kombination mit dem **KLOSETTBECKEN MIT VERSETZTEM ABFLUSS** und dem hinten **OFFENEN BIDET** ist es ideal, um im Zuge von Renovierungen an bestehende Anlagen angepasst zu werden.

Une idée de projet à 360° est à la base de la recherche Hatria qui ne cesse d'évoluer pour pouvoir proposer de nouvelles solutions alliant esthétique et fonctionnalité. Le design construit la forme autour de systèmes qui concourent à améliorer la qualité et les performances du produit. **PURE FIX®**, le nouveau système de fixation de sol invisible pour cuvettes de WC et bidets au ras du mur fait partie de la dernière collection d'Hatria « Le Fiabe ». C'est l'innovation qui permet finalement d'avoir des sanitaires au sol avec un résultat esthétiquement parfait et propre, puisqu'aucun système de fixation n'est visible. Combiné avec la **CUVETTE DÉCALÉE** et le **BIDET OUVERT** dos au mur, il est l'idéal dans les rénovations pour adapter les installations déjà existantes.

La investigación de Hatria, que parte de una idea de proyecto 360°, evoluciona constantemente para ofrecer nuevas soluciones que combinen estética y eficiencia; el diseño crea la forma en torno a sistemas que mejoran la calidad y el rendimiento del producto. **PURE FIX®**, la nueva fijación invisible para inodoros y bidés de tierra y contra la pared, presente en la última colección de Hatria "Le Fiabe", es la innovación que permite que sanitarios de tierra también dispongan finalmente de un resultado estéticamente perfecto y limpio sin fijaciones visibles. Junto con el **INODORO VARIABLE** y el **BIDÉ ABIERTO** en su parte posterior, es ideal en reestructuraciones para adaptar instalaciones ya existentes.

Идея проекта на 360° лежит в основе научно-исследовательской работы компании Hatria, которая постоянно развивается, чтобы предложить новые решения, объединив эстетику и функциональность: дизайн создает форму систем, которые улучшают качество и достоинства продукта. **PURE FIX®** – это новая скрытая система монтажа приставных биде и унитазов, представленная в новой коллекции "Le Fiabe" компании Hatria. Являясь инновационной, она позволяет, наконец-то, идеально и чисто устанавливать напольную сантехнику без каких-либо видимых крепежных устройств. Сочетание **УНИТАЗА С ПЕРЕНОСНЫМ ВЫПУСКОМ** и **ОТКРЫТОГО** в задней части **БИДЕ** будет идеальным для проведения ремонтных работ с целью установки их в уже существующую систему.



IL DESIGN SEGUE LE FORME DELL'INNOVAZIONE

DESIGN FOLLOWING THE CONTOURS OF INNOVATION
DAS DESIGN PASST SICH DEN FORMEN DER INNOVATION AN
LE DESIGN ÉPOUSE LES FORMES DE L'INNOVATION
EL DISEÑO SIGUE LA FORMA DE LA INNOVACIÓN
ДИЗАЙН СЛЕДУЕТ ЗА ИННОВАЦИОННЫМИ ФОРМАМИ





Le fiabe

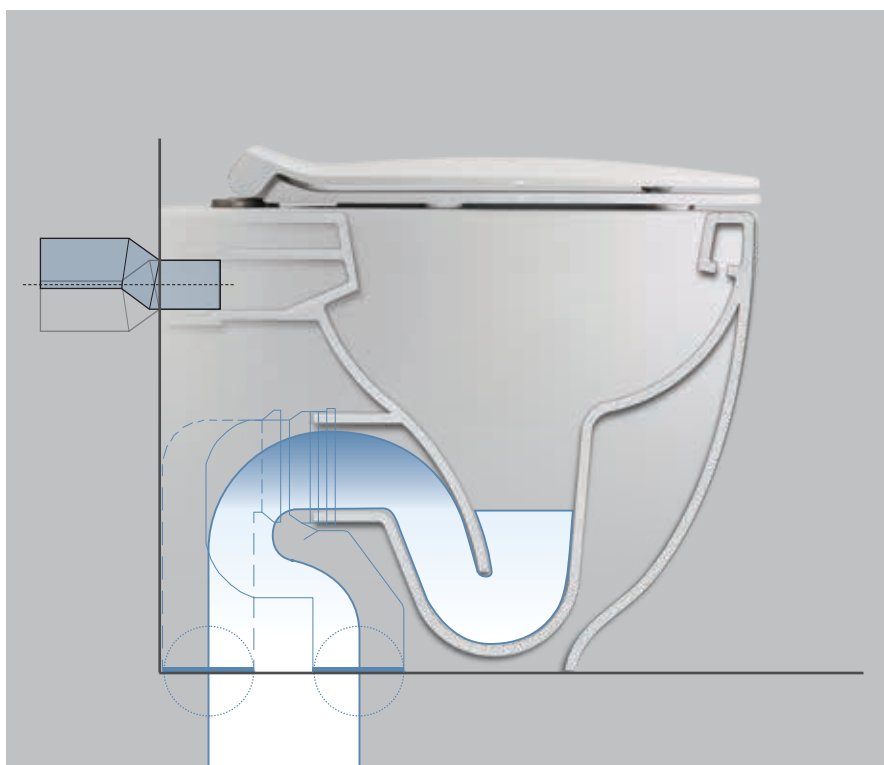

Abbinamenti consigliati *Suggested combinations*

VALLEY p. 116



600x400

NIDO p. 142



750x370

HAPPY HOUR p. 108



550x405



700x400

HAPPY HOUR SLIM p. 88



250x250



400x400



440x440

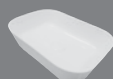

550x380

VASCA OVALE BT_01



1700x780x600

VASCA RETTANGOLARE BT_02



1700x740x590

LE FIABE



1000x485



810x485



600x485



PURE RIM



365x555



PURE RIM

TRASLATO

OPEN BIDET



365x555



PURE RIM



365x660x815



50



365x500



01 BIANCO
WHITE



01

01: VASO + BIDET SOSPESI
01: wall hung wc + bidet



02



02: LAVABO 80, VASO + BIDET SOSPESI

02: washbasin 80, wall hung wc + bidet



03

03: VASO + BIDET FILO MURO

03: back to wall wc + bidet



04



05

04: VASO + BIDET FILO MURO
05: VASO MONOBLOCCO CON CASSETTA

*04: back to wall wc + bidet
05: coupled wc with cistern*



06-07: VASO + BIDET 50 FILO MURO
08: LAVABO 60, VASO + BIDET 50 FILO MURO

*06-07: back to wall wc + bidet 50
08: washbasin 60, back to wall wc + bidet 50*







09: LAVABO 60, VASO + BIDET 50 SOSPESI
10: VASO + BIDET 50 SOSPESI

09: wall hung washbasin 60, wall hung wc + bidet 50
10: wall hung wc + bidet 50



11: LAVABO 100
12: DOPPIO LAVABO 60

*11: washbasin 100
12: double washbasin 60*



13: LAVABO 80, MOBILE 80 SPATOLATO BIANCO, 2 CASSETTI TORTORA
14: LAVABO 80, MOBILE 80 SPATOLATO BIANCO, 2 CASSETTI CEMENTO

13: washbasin 80, furniture 100 white "cement effect", 2 tortora drawers
14: washbasin 80, furniture 100 white "cement effect", 2 cement drawers



HAPPY HOUR SLIM

NUOVA ESTETICA DAI BORDI ULTRASOTTILI
NEW LOOK WITH ULTRA-THIN EDGES



FUSION p. 54



FUSION 355x540

FUSION 48 350x480



FUSION COMPACT 355x485

BEAT p. 66



360x520

BIANCA p. 46



360x520

NIDO p. 142



360x560

LE FIABE p. 72



365x555

370x555



365x500

HAPPY HOUR SLIM



250x250



400x400



440x440



500x380



550x380



01 BIANCO
WHITE



25 BIANCO MATT
WHITE MATT

12 AVORIO
IVORY

29 TABACCO
TOBACCO

28 CRETA
CRETE

46 SELVA
FOREST

26 SABBIA
SAND

07 CEMENTO
CEMENT

08 ANTRACITE
ANTHRACITE

45 CENERE
ASH

06 LAVAGNA
BLACKBOARD

02 NERO MATT
BLACK MATT



01

BIANCO MATT / WHITE MATT

01: HAPPY HOUR SLIM 06:00s



NERO MATT / BLACK MATT

02: HAPPY HOUR SLIM 05:00s CON PILETTA IN CERAMICA

03: HAPPY HOUR SLIM 06:00s, WC + BIDET FUSION

02: HAPPY HOUR SLIM 05:00s with ceramic drain



CRETA / CRETE

04: HAPPY HOUR SLIM 05:00s CON PILETTA IN CERAMICA

04: HAPPY HOUR SLIM 05:00s with ceramic drain



05



AVORIO / IVORY

05: HAPPY HOUR SLIM 06:00s, WC + BIDET FUSION, PETRA_H3 ARDESIA SHOWER TRAY





TABACCO / TOBACCO

06: HAPPY HOUR SLIM 07:00s CON PILETTA IN CERAMICA, WC + BIDET FUSION
 07: HAPPY HOUR SLIM 06:00s CON PILETTA IN CERAMICA, WC + BIDET FUSION

06: HAPPY HOUR SLIM 07:00s with ceramic drain
07: HAPPY HOUR SLIM 06:00s with ceramic drain



LAVAGNA / BLACKBOARD

08: HAPPY HOUR SLIM 11:00s CON PILETTA IN CERAMICA, WC + BIDET FUSION
09: HAPPY HOUR SLIM 06:00s CON PILETTA IN CERAMICA, WC FUSION

08: HAPPY HOUR SLIM 11:00s with ceramic drain
09: HAPPY HOUR SLIM 06:00s with ceramic drain





CENERE / ASH

10: HAPPY HOUR SLIM 07:00s CON PILETTA IN CERAMICA, WC + BIDET FUSION

10: HAPPY HOUR SLIM 07:00s with ceramic drain



11

CENERE / ASH

11: HAPPY HOUR SLIM 06:00s CON PILETTA IN CERAMICA, WC FUSION

11: HAPPY HOUR SLIM 06:00s with ceramic drain





14

SABBIA / SAND

- 12: HAPPY HOUR SLIM 18:00s CON PILETTA IN CERAMICA
13: HAPPY HOUR SLIM 06:00s CON PILETTA IN CERAMICA
14: HAPPY HOUR SLIM 11:00s CON PILETTA IN CERAMICA

*12: HAPPY HOUR SLIM 18:00s with ceramic drain
13: HAPPY HOUR SLIM 06:00s with ceramic drain
14: HAPPY HOUR SLIM 11:00s with ceramic drain*





ANTRACITE / ANTHRACITE

- 15: HAPPY HOUR SLIM 06:00s CON PILETTA IN CERAMICA
 16: HAPPY HOUR SLIM 18:00s CON PILETTA IN CERAMICA

CEMENTO / CEMENT

- 17: HAPPY HOUR SLIM 18:00s CON PILETTA IN CERAMICA, WC + BIDET FUSION

- 15: HAPPY HOUR SLIM 06:00s with ceramic drain
 16: HAPPY HOUR SLIM 18:00s with ceramic drain
 17: HAPPY HOUR SLIM 18:00s with ceramic drain, wc + bidet FUSION





16

CEMENTO / CEMENT

15: HAPPY HOUR SLIM 06:00s CON PILETTA IN CERAMICA, PETRA_H3 ARDESIA SHOWER TRAY
 16: HAPPY HOUR SLIM 11:00s CON PILETTA IN CERAMICA, PETRA_H3 ARDESIA SHOWER TRAY

*15: HAPPY HOUR SLIM 06:00s with ceramic drain, PETRA_H3 Ardesia shower tray
 16: HAPPY HOUR SLIM 11:00s with ceramic drain, PETRA_H3 Ardesia shower tray*



HAPPY HOUR

DESIGN E PERSONALITÀ PER OGNI ORA
DESIGN AND PERSONALITY FOR EVERY HOUR



BIANCA p. 46

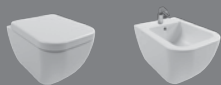

360x520

FUSION p. 54



FUSION 355x540

FUSION 48 350x480

NIDO p. 142



365x550

365x550



360x560

HAPPY HOUR



475x475



470x470



480x480



400x400



700x400



550x405



500x380



440x440



01 BIANCO
WHITE

Trilogy Gold edition

B6 ORO GIALLO
YELLOW GOLD

39 ORO BIANCO
WHITE GOLD

30 ORO ROSSO
RED GOLD



01: HAPPY HOUR 10:00
02: HAPPY HOUR 03:00
03: HAPPY HOUR 17:00



04: HAPPY HOUR 07:15
05: HAPPY HOUR 11:15



06: HAPPY HOUR 02:00
 07: HAPPY HOUR 22:00
 08: HAPPY HOUR 09:00
 09: HAPPY HOUR 09:30



10



11

10: HAPPY HOUR 11:00
11: HAPPY HOUR 07:00, VASO + BIDET ABITO

11: HAPPY HOUR 07:00, wc + bidet ABITO



12



13

TRILOGY

12: HAPPY HOUR 07:00 ORO GIALLO bicolor
 13: HAPPY HOUR 07:00 ORO ROSSO bicolor

*12: HAPPY HOUR 07:00 yellow gold bicolor
 13: HAPPY HOUR 07:00 red gold bicolor*



PENCIL / VALLEY

ARREDARE CON LA PROPRIA PRESENZA
FURNISH WITH ITS PRESENCE



Abbinamenti consigliati *Suggested combinations*

BEAT p. 66



360x520

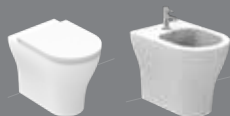

360x520

NEXT p. 38

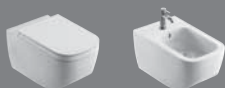

360x560

FUSION p. 54



FUSION 355x540



FUSION 48 350x480



FUSION 355x540



FUSION 48 350x480



FUSION Q 360x530

LE FIABE p. 72

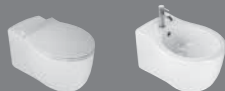

365x560



365x500

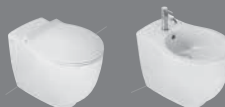

365x560



365x500

PENCIL



550x380



400x400

VALLEY



600x400



01 BIANCO
WHITE



01



02

PENCIL

- 01: LAVABI 40
- 02: LAVABO 55

- 01: washbasins 40*
- 02: washbasin 55*



03

VALLEY

03: LAVABO 60

03: washbasin 60



04

VALLEY

04: LAVABO 60

04: washbasin 60



AREA

UN SISTEMA DI EQUILIBRI TRA FORME E SPAZI
A SYSTEM OF BALANCES BETWEEN FORMS AND SPACES



FUSION p. 54



FUSION 355x540

FUSION 48 350x480



FUSION COMPACT 355x485

AREA



810x450



900x450



1100x350



900x350



700x350



600x450



1000x350



800x350



01 BIANCO
WHITE



01: LAVABI 60x45 CON SEMICOLONNA
 02: LAVABO 100x35 D'APPOGGIO

01: washbasins 60x45 with siphon cover
 02: surface-mounted washbasin 100x35



03: LAVABO 90x45, VASO + BIDET FUSION,
MOBILI SLIDING WOOD SYSTEM
04: LAVABO 80x35 D'APPOGGIO

03: washbasin 90x45, wc + bidet FUSION, furniture SLIDING wood system
04: surface-mounted washbasin 80x35



05



06



07

05: LAVABO 90x35, VASO + BIDET FUSION
 06: LAVABO 110x35
 07: LAVABI 70x35

05: washbasin 90x35, wc + bidet FUSION
 06: washbasin 110x35
 07: washbasins 70x35



CANALGRANDE

SOTTILISSIMO MA FORTE
EXTRA-SLIM, YET STRONG



BIANCA p. 46

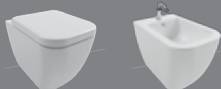
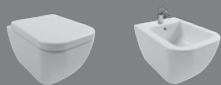

360x520

NEXT p. 38

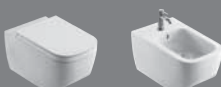

360x560

FUSION p. 54

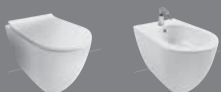

FUSION 355x540



FUSION Q 360x530

CANALGRANDE



1000x500



810x500



600x500



01 BIANCO
WHITE



01

01: LAVABO 100

01: washbasin 100



02: LAVABO 100
02: washbasin 100



03: LAVABO 80
04: LAVABO 60

03: washbasin 80
04: washbasin 60



GRANDANGOLO

IL BAGNO CAMBIA PROSPETTIVA
A BATHROOM TO INSPIRE THE DIMENSION



FUSION p. 54



FUSION 355x540

FUSION 48 350x480



FUSION Q 360x530

GRANDANGOLO



1500x500



1300x500



1000x500



750x500 dx-rh



750x500 sx-lt



500x500 dx-rh



500x500 sx-lt



1300x500x335 T dx-rh



1300x500x335 T sx-lt



01 BIANCO
WHITE



01

01: LAVABO G-130 T DX, MOBILE 130 T DX SPATOLATO TORTORA 3 ANTE

01: washbasin G-130 T rh, furniture 130 T rh tortora "cement effect" 3 doors



02: LAVABO G-100, MOBILE 100 SPATOLATO BIANCO, 2 CASSETTI TORTORA

02: washbasin G-100, furniture 100 white "cement effect", 2 tortora drawers



03

03: LAVABO G-100, MOBILE 100 BAMBOO, 1 CASSETTO

03: washbasin G-100, furniture 100 bamboo, 1 drawer



04: LAVABO G-50 SINISTRO - DESTRO
05: LAVABO G-150

*04: washbasin G-50 left - right
05: washbasin G-150*



06

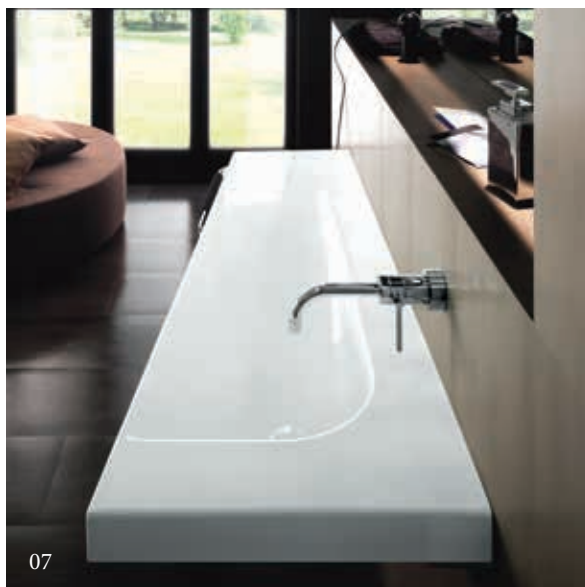

07



08

06: LAVABO G-75 DESTRO
 07: LAVABO G-130 T SINISTRO
 08: LAVABO G-150, VASO + BIDET SOSPESI FUSION

*06: washbasin G-75 right
 07: washbasin G-130 T left
 08: washbasin G-150, wall hung wc + bidet FUSION*



NIDO

LINEE MORBIDE E DELICATE PER IL TUO BAGNO
SMOOTH AND DELICATE LINES FOR YOUR BATHROOM

NIDO



HAPPY HOUR *p. 108*



475x475



470x470



398x398



550x405



700x400

HAPPY HOUR SLIM *p. 88*



250x250



400x400



440x440



500x380



550x380

NIDO



680x480



620x470



560x445



750x370



365x550



365x550



360x560



355x655x800



01 BIANCO
WHITE



01: LAVABI 68, VASO SOSPESO

01: washbasin 68, wall hung wc



- 02: LAVABO 75 D'APPOGGIO
03: VASO + BIDET FILO MURO
04: VASO + BIDET SOSPESI
-
- 02: *surface-mounted washbasin 75*
03: *back to wall wc + bidet*
04: *wall hung wc + bidet*



05



06



07



08

- 05: LAVABO 56 CON SEMICOLONNA
 06: LAVABO 62 CON COLONNA
 07: VASO MONOBLOCCO CON CASSETTA
 08: VASO FILO MURO + MONOLITH

*05: washbasin 56 with siphon cover
 06: washbasin 62 with pedestal
 07: coupled wc with cistern
 08: back to wall wc + MONOLITH*

PIATTI DOCCIA IN CERAMICA

CERAMIC SHOWER TRAYS

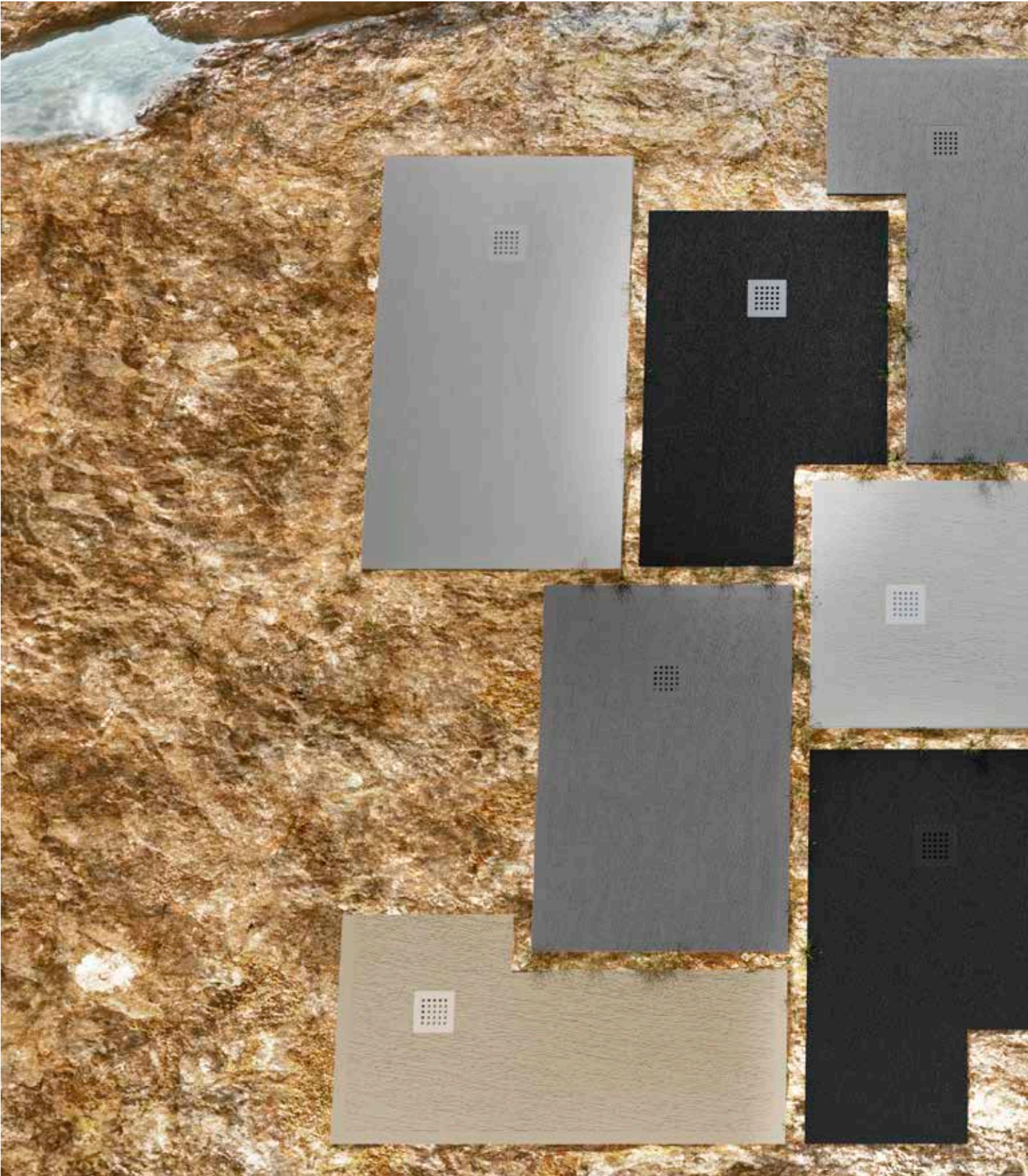

PETRA_H3 Ardesia

DESIGN, AFFIDABILITÀ E VERSATILITÀ CHE RIDISEGNANO GLI SPAZI DOCCIA
DESIGN, RELIABILITY AND VERSATILITY THAT REDESIGN SHOWER SPACES



BAHIA_13 p. 20



1000x465 800x465 dx-rh 800x465



600x465 500x465

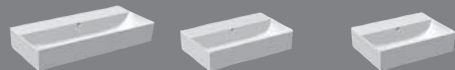

800x365 600x365 500x365



450x250 500x380

HAPPY HOUR SLIM p. 88



250x250 400x400 440x440



500x380 550x380

FUSION p. 54



FUSION 355x540



BIANCA p. 46



360x520



PETRA H3_ARDESIA

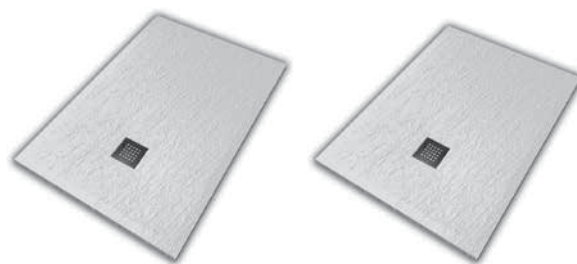

1400x800 1200x800

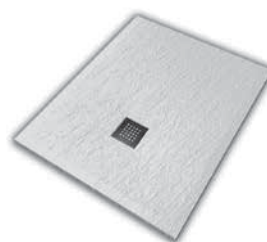

1000x800

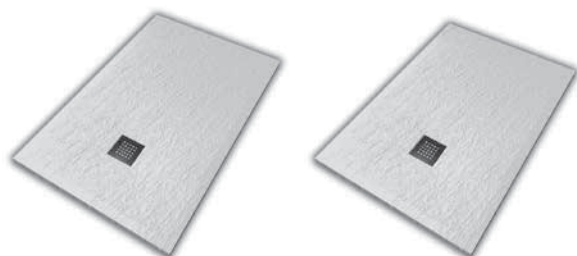

1400x700 1200x700



1000x700



- 01 BIANCO
WHITE
- 12 AVORIO
IVORY
- 07 CEMENTO
CEMENT
- 02 NERO
BLACK



INIMITABILE DESIGN E TECNOLOGIA CERAMICA “MADE IN ITALY”

Inimitable Design and "Made in Italy" ceramic technology
 Unnachahmliches Design und Keramiktechnologie "Made in Italy"
 Design inimitable et technologie céramique «Made in Italy»
 Diseño inimitable y tecnología cerámica "Made in Italy"
 Неповторимый дизайн и технология "Made in Italy"

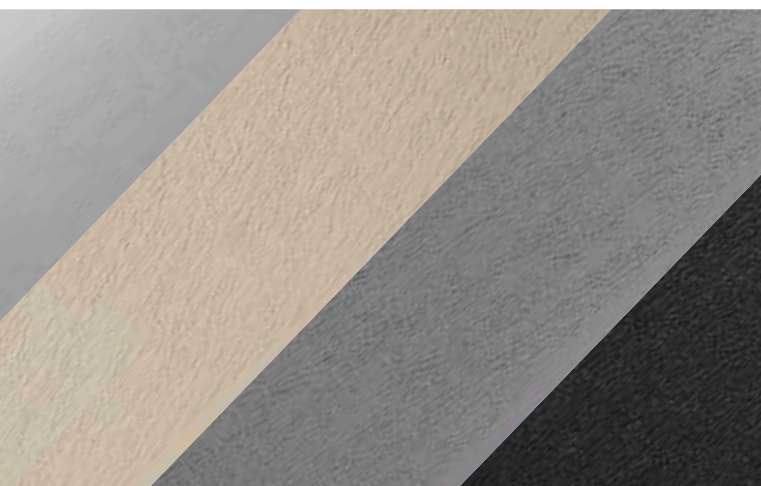

Petra_H3 Ardesia è la nuova linea di piatti doccia in ceramica realizzata da Hatria grazie ai recenti investimenti tecnologici che permettono di raggiungere altissimi livelli estetici e funzionali. Questa nuova linea di piatti doccia dall'unica superficie ceramica ispirata all'ardesia, permette di avere una finitura naturale, con dettagli in altissima definizione, e incredibilmente materica, conferendo alla "zona doccia" un aspetto unico, elegante e molto ricercato. La collezione Petra_H3 Ardesia è realizzata integralmente "Made in Italy" ed è disponibile in 6 dimensioni (da 100x70, fino al 140x80cm) e 4 colori, studiati con tonalità che permettono di inserirli in modo armonioso in tutti gli ambienti bagno, sia in appoggio che filo pavimento, grazie allo spessore di soli 3 cm. Gli accessori coordinati di altissima qualità, come la speciale piletta in acciaio inox o colorata in tinta con il piatto doccia, completano l'offerta, permettendo di raggiungere il massimo risultato estetico.

Petra_H3 Ardesia is the new line of ceramic shower trays created by Hatria thanks to recent technological investments that allow it to reach very high aesthetic and functional levels. This new line of shower trays with an original ceramic surface inspired by slate, allows for a natural finish, with extremely high definition details and incredibly material, giving the "shower area" a unique, elegant and highly refined look. The Petra_H3 Ardesia collection is entirely "Made in Italy" and it is available in 6 sizes (from 100x70, up to 140x80cm) and 4 colors, designed with colours that allow them to be inserted harmoniously in all bathrooms, both in at the floor level and above the floor, thanks to the thickness of only 3 cm. The coordinated accessories of the highest quality, such as the special stainless steel drain or colored matching the shower tray, complete the offer, allowing you to achieve the maximum aesthetic result.

Petra_H3 Ardesia ist die neue Linie von Keramik-Duschwannen, die Hatria dank der jüngsten technologischen Investitionen entwickelt hat, die es ermöglicht haben, ein sehr hohes ästhetisches und funktionales Niveau zu erreichen. Diese neue Kollektion von Duschwannen mit einer einzigen Keramikoberfläche, die von Schiefer inspiriert ist, ermöglicht ein natürliches Finish mit extrem hochauflösenden Details und unglaublichem Material und verleiht dem "Duschraum" ein einzigartiges, elegantes und begehrtes Aussehen. Die Petra_H3 Ardesia-Kollektion wird vollständig "Made in Italy" hergestellt und ist in 6 Größen (von 100 x 70 bis 140 x 80 cm) und 4 Farben erhältlich. Die Farben sind so gestaltet, dass sie sich harmonisch in alle Badezimmer einfügen werden, sowohl aufgesetzt als auch zur Bodenebene, dank der Dicke von nur 3 cm. Das abgestimmte Zubehör ist von höchster Qualität, wie der spezielle Edelstahlablauf oder farblich passend zur Duschwanne, runden das Angebot ab und ermöglicht Ihnen ein maximales ästhetisches Ergebnis.

Petra_H3 Ardesia est la nouvelle ligne de receveurs de douche en céramique créée par Hatria qui grâce aux récents investissements technologique, qui lui permettent d'atteindre des niveaux esthétiques et fonctionnels très élevés. Cette nouvelle ligne de receveurs de douche avec une seule surface en céramique unique inspirée de l'ardoise, permet une finition naturelle, avec des détails de haute définition, et une matière incroyable, donnant à la "zone de douche" un aspect unique, élégant et très raffiné. La collection Petra_H3 Ardesia est entièrement réalisée "Made in Italy" et est disponible en 6 tailles (de 100x70, jusqu'à 140x80cm) et 4 couleurs, conçues dans des tonalités qui leur permettent de s'intégrer harmonieusement dans toutes les salles de bains, à la fois posés et au ras du sol, grâce à une épaisseur de seulement 3 cm. Les accessoires coordonnés de la plus haute qualité, tels que la bonde spéciale en acier inoxydable ou colorée pour correspondre au receveur de douche, complètent l'offre, vous permettant d'obtenir le résultat esthétique maximal.

Petra_H3 Ardesia es la nueva línea de platos de ducha cerámicos creada por Hatria gracias a las recientes inversiones tecnológicas que le permiten alcanzar niveles estéticos y funcionales muy elevados. Esta nueva línea de platos de ducha con una original superficie cerámica inspirada en la pizarra, permite un acabado natural, con detalles de altísima definición e increíblemente material, dando a la "zona de ducha" un aspecto único, elegante y muy refinado. La colección Petra_H3 Ardesia es íntegramente "Made in Italy" y está disponible en 6 tamaños (desde 100x70, hasta 140x80cm) y 4 colores, diseñados con colores que permiten insertarlos armoniosamente en todos los baños, tanto a nivel del suelo y por encima del suelo, gracias al grosor de tan solo 3 cm. Los complementos coordinados de altísima calidad, como el desagüe especial de acero inoxidable o el plato de ducha de color a juego, completan la oferta, permitiéndote conseguir el máximo resultado estético.

Petra_H3 Ardesia - это новая линия керамических душевых поддонов, созданная фабрикой Hatria благодаря недавним технологическим инвестициям, которые позволяют достичь очень высокого эстетического и функционального уровня. Эта новая линия душевых поддонов с единой керамической поверхностью, вдохновленной сланцем, обеспечивает естественную отделку с деталями чрезвычайно высокой четкости и невероятным материалом, что придает «душевой зоне» уникальный, элегантный и очень изысканный вид. Коллекция Petra_H3 Ardesia полностью «Made in Italy» и доступна в 6 размерах (от 100x70 до 140x80 см) и 4 цветах, с оттенками, которые позволяют гармонично вписать их во все ванные комнаты, как в на пол, так и вровень с полом благодаря толщине всего 3 см. Дополнительные аксессуары высочайшего качества, такие как специальный слив из нержавеющей стали или окрашенный в тон душевого поддона, дополняют предложение, позволяя достичь максимального эстетического результата.



ANTIMACCHIA
Stain resistant
Fleckenbeständig
Résistant aux taches
Resistente a las manchas
Устойчивость к пятнам
UNI 4543



SEMPLICE DA PULIRE
Simple to clean
Einfach zu reinigen
Simple à nettoyer
Simple de limpiar
Легко чистить



SUPERFICIE ANTIBATTERICA
Antibacterial surface
Antibakterielle Oberfläche
Surface antibactérienne
Superficie antibacteriana
Антибактериальная поверхность



RESISTENTE AGLI ACIDI, ALCALI
Resistant to acids, alkalis
Beständig gegen Säuren, Laugen
Résistant aux acides, aux alcalis
Resistente a ácidos, álcalis
Устойчив к кислотам, щелочам



ANTISCIVOLO
Non-slip
Rutschfest
Antidérapant
Antideslizante
Нескользящий
RA_DIN 51097



PILETTA GEBERIT
Geberit drain
Geberit-Ablauf
Bonde Geberit
Drenaje Geberit
Слив Geberit

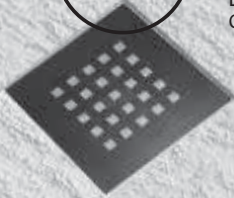

SICUREZZA E AFFIDABILITÀ AL 100%

100% Safety and Reliability
100% Sicherheit und Zuverlässigkeit
100% sécurité et fiabilité
100% seguridad y confiabilidad
100% безопасность и надежность

I piatti doccia Petra_H3 Ardesia sono realizzati con un'esclusiva tecnologia capace di offrire lo stesso risultato estetico della pietra ardesia utilizzando la ceramica, il materiale più duraturo e affidabile nel tempo per eccellenza. L'innovativo processo tecnologico ad alta pressione consente di ottenere un prodotto di elevatissima qualità utilizzando solo materiali naturali, in contrapposizione netta con i composti sintetici e le resine che non riescono, per propria natura, a garantire performance consistenti nel tempo. Lo smalto ceramico antibatterico Hatria rende particolarmente igienico il piatto doccia, facile da pulire (anti-macchia, testato UNI 4543, blu dimetilene, inchiostro, tintura di iodio e permanganato di potassio) e conferisce caratteristiche nettamente superiori in termini di durata e resistenza rispetto alle superfici in resina (che contrariamente sono porose, e potrebbero tendere ad assorbire agenti esterni). I laboratori Hatria hanno infine arricchito lo smalto di Petra_H3 Ardesia con proprietà anti-scivolo (aderenti alle normative Europee DIN 51097) per assicurare la massima sicurezza durante l'utilizzo.

Petra_H3 Ardesia shower trays are made with an exclusive technology capable of offering the same aesthetic result as slate stone using ceramic, the most durable and reliable material par excellence over time. The innovative high-pressure technological process makes it possible to obtain a high quality product using only natural materials, in clear contrast with synthetic composites and resins that cannot, by their very nature, guarantee consistent performance over time. The Hatria antibacterial ceramic glaze makes the shower tray particularly hygienic, easy to clean (anti-stain, UNI 4543 tested, dimethylene blue, ink, iodine dye and potassium permanganate) and confers clearly superior characteristics in terms of durability and resistance compared to resin surfaces (which, on the contrary, are porous, and could tend to absorb external agents). Finally, the Hatria laboratories have enriched the Petra_H3 Ardesia glaze with anti-slip properties (in compliance with the European DIN 51097 standards) to ensure maximum safety during use.

Petra_H3 Ardesia Duschwannen werden mit einer exklusiven Technologie hergestellt, die das gleiche ästhetische Ergebnis wie Schieferstein mit Keramik erzielen kann, dem haltbarsten und zuverlässigsten Material schlechthin im Laufe der Zeit. Das innovative technologische Hochdruckverfahren ermöglicht es, ein Produkt von höchster Qualität nur mit natürlichen Materialien zu erhalten, im Gegensatz zu synthetischen Verbundwerkstoffen und Harzen, die naturgemäß nicht in der Lage sind, über einen längeren Zeitraum eine gleichbleibende Qualität zu gewährleisten. Die antibakterielle Keramikglasur von Hatria macht die Duschwanne besonders hygienisch, leicht zu reinigen (Anti-Fleck UNI 4543 getestet, Dimethylenblau, Tinte, Jodfarbstoff und Kaliumpergament)

und bietet deutlich überlegene Eigenschaften hinsichtlich Haltbarkeit und Beständigkeit im Vergleich zu Harzoberflächen (die im Gegenteil porös sein und könnten dazu neigen externe Mittel zu absorbieren). Schließlich haben die Hatria-Labors die Petra_H3 Ardesia-Glasur mit rutschfesten Eigenschaften (gemäß den europäischen Normen DIN 51097) angereichert, um maximale Sicherheit während des Gebrauchs zu gewährleisten.

Les receveurs de douche Petra_H3 Ardesia sont fabriqués avec une technologie exclusive capable d'offrir le même résultat esthétique que la pierre d'ardoise en utilisant la céramique, le matériau par excellence le plus durable et le plus fiable dans le temps. Le procédé technologique innovant à haute pression permet d'obtenir un produit de très haute qualité en utilisant uniquement des matériaux naturels, en contraste frappant avec les composites synthétiques et les résines qui sont incapables, par leur nature même, d'assurer des performances constantes dans le temps. L'émail céramique antibactérien Hatria rend le receveur de douche particulièrement hygiénique, facile à nettoyer (anti-taches, testé UNI 4543, bleu de méthylène, encre, colorant iodé et permanganate de potassium) et confère des caractéristiques nettement supérieures en termes de durabilité et de résistance par rapport aux surfaces en résine (qui, au contraire, sont poreuses, et pourraient ont tendance à absorber les agents externes). Enfin, les laboratoires Hatria ont enrichi l'émail Petra_H3 Ardesia de propriétés antidérapantes (adhérant aux normes européennes DIN 51097) pour assurer une sécurité maximale lors de l'utilisation.

Los platos de ducha Petra_H3 Ardesia están fabricados con una tecnología exclusiva capaz de ofrecer el mismo resultado estético que la piedra pizarra utilizando cerámica, el material más duradero y fiable por excelencia en el tiempo. El innovador proceso tecnológico de alta presión permite obtener un producto de alta calidad utilizando únicamente materiales naturales, en claro contraste con los componentes sintéticos y resinas que no pueden, por su propia naturaleza, garantizar un rendimiento constante en el tiempo. El esmalte cerámico antibacteriano Hatria hace que el plato de ducha sea especialmente higiénico, fácil de limpiar (anti manchas, probado UNI 4543, azul de dimetileno, tinta, colorante de yodo y permanganato de potasio) y le confiere unas características claramente superiores en cuanto a durabilidad y resistencia a las superficies de resina (que, por el contrario, son porosas, pudiendo tender a absorber agentes externos). Finalmente, los laboratorios de Hatria han enriquecido el esmalte Petra_H3 Ardesia con propiedades antideslizantes (en cumplimiento de las normas europeas DIN 51097) para garantizar la máxima seguridad durante el uso.

Душевые поддоны Petra_H3 Ardesia изготовлены по эксклюзивной технологии, способной обеспечить такой же эстетический результат, как и сланцевый камень, с использованием керамики, самого прочного и надежного материала даже с течением времени. Инновационный технологический процесс высокого давления позволяет получить продукт высочайшего качества, используя только натуральные материалы, в отличие от синтетических композитов и смол, которые по самой своей природе не могут обеспечить стабильные характеристики с течением времени. Антибактериальная керамическая эмаль Hatria делает душевой поддон особенно гигиеничным, легким в уходе (защищает от пятен испытано UNI 4543, диметиленовый синий, чернила, йодный краситель и калиевый пергмент) и обеспечивает явно лучшие характеристики с точки зрения долговечности и устойчивости по сравнению с полимерными поверхностями (которые, напротив, пористы и имеют свойство поглощать внешние агенты). Наконец, лаборатории Hatria обогатили эмаль Petra_H3 Ardesia противоскользящими свойствами (в соответствии с европейскими стандартами DIN 51097), чтобы обеспечить максимальную безопасность во время использования.

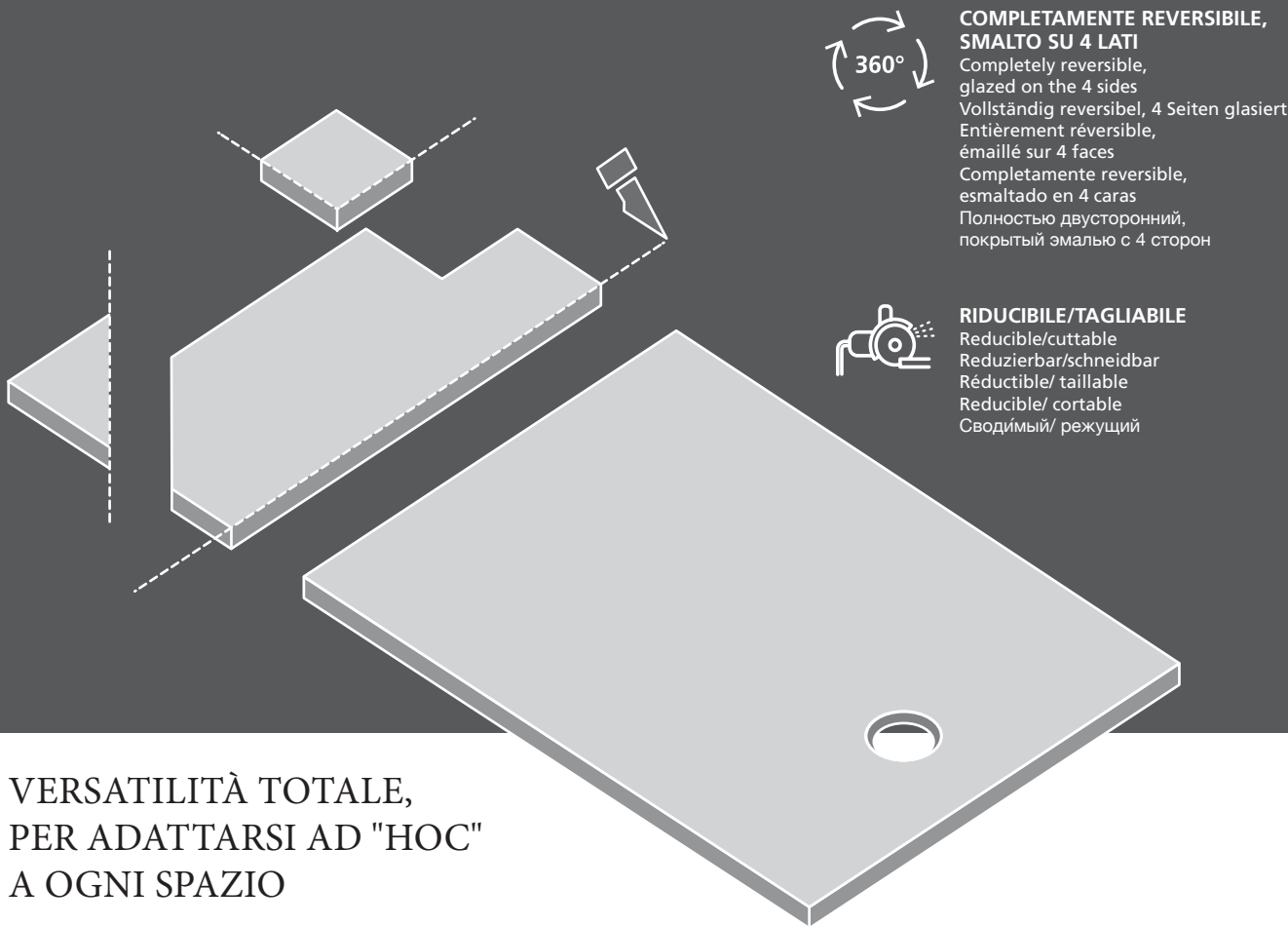

**COMPLETAMENTE REVERSIBILE,
SMALTO SU 4 LATI**

Completely reversible,
glazed on the 4 sides
Vollständig reversibel, 4 Seiten glasiert
Entièrement réversible,
émaillé sur 4 faces
Completamente reversible,
esmaltado en 4 caras
Полностью двусторонний,
покрытый эмалью с 4 сторон



RIDUCIBILE/TAGLIABILE

Reducible/cuttable
Reduzierbar/schneidbar
Réductible/ taillable
Reducible/ cortable
Сводимый/ режущий

**VERSATILITÀ TOTALE,
PER ADATTARSI AD "HOC"
A OGNI SPAZIO**

Total versatility, to suit to any space
Absolute Vielseitigkeit, um sich ad hoc an jeden Raum anzupassen
Polyvalence totale, pour s'adapter sur mesure à n'importe quel espace
Total versatilidad, para adaptarse a cualquier espacio
Полная универсальность, позволяющая адаптировать его к любому пространству

Nasce una nuova generazione di piatti doccia in ceramica che offre un'estrema flessibilità, grazie ai bordi smaltati sui 4 lati che garantiscono l'adattabilità in ogni tipologia di area doccia. Maggiormente, e grazie all'impasto sviluppato nei laboratori di Hatria, il piatto doccia Petra_H3 Ardesia è riducibile, quindi può essere ordinato tagliato su misura, per adattarsi con facilità a qualsiasi progetto bagno. Un valore aggiunto che traduce lo stile sartoriale tipico del Made in Italy nel linguaggio della ceramica, dando vita a una linea di piatti doccia versatile, di facile installazione e che diventi protagonista dell'ambiente bagno grazie ad un design che sposa le ultime tendenze dell'interior design.

A new generation of ceramic shower trays is born that offers extreme flexibility, thanks to the glaze edges on the 4 sides that provide adaptability in any type of shower area. More, thanks to the ceramic body developed in the Hatria laboratories, the Petra_H3 Ardesia shower tray is reducible, so it can be ordered with customized cut, to easily adapt to any bathroom project. An added value that translates the tailored style typical of Made in Italy into the language of ceramics, giving life to a line of versatile, easy-to-install shower trays and becoming the protagonist of the bathroom thanks to a design that marries the latest interior trends design.

Es entsteht eine neue Generation von Duschwannen aus Keramik, die dank der emaillierten Kanten an den 4 Seiten, die Anpassungsfähigkeit in jeder Art von Duschbereich gewährleisten, extreme Flexibilität bietet. Noch wichtiger ist, dass dank der in den Hatria-Labors entwickelten Mischung die Duschwanne Petra_H3 Ardesia kürzbar ist, sodass sie zugeschnitten werden kann, um sich problemlos an jedes Badezimmerprojekt anpassen zu können. Ein Mehrwert, der den für Made in Italy typischen Modestil in die Sprache der Keramik übersetzt und eine Reihe vielseitiger, einfach zu installierender Duschwannen zum Leben erweckt, die dank eines Designs, das die neuesten Trends vereint, zum Protagonisten des Badezimmers werden Innenarchitektur.

Une nouvelle génération de receveurs de douche en céramique est née, elle offre une flexibilité extrême, grâce aux bords émaillés sur les 4 côtés qui garantissent l'adaptabilité dans tout type de zone de douche. Plus important encore, grâce au mélange développé dans les laboratoires Hatria, le receveur de douche Petra_H3 Ardesia est réductible, il peut donc être commandé sur mesure, pour s'adapter facilement à tout projet de salle de bain. Une valeur ajoutée qui traduit le style vestimentaire typique du Made in Italy dans le langage de la céramique, donnant vie à une ligne de receveurs de douche polyvalents et faciles à installer qui deviennent le protagoniste de la salle de bain grâce à un design qui épouse les dernières tendances en matière de design d'intérieur.

Nace una nueva generación de platos de ducha cerámicos que ofrecen una flexibilidad extrema, gracias a los cantos vidriados en los 4 lados que aportan adaptabilidad en cualquier tipo de zona de ducha. Además, gracias al cuerpo cerámico desarrollado en los laboratorios Hatria, el plato de ducha Petra_H3 Ardesia es reducible, por lo que se puede pedir con corte personalizado, para adaptarse fácilmente a cualquier proyecto de baño. Un valor añadido que traduce el estilo sastrero típico del Made in Italy al lenguaje de la cerámica, dando vida a una línea de platos de ducha versátiles y fáciles de instalar y convirtiéndose en protagonista del baño gracias a un diseño que casa con el interior más actual, diseño de tendencias.

Рождение нового поколения керамических душевых поддонов, обладающих исключительной гибкостью благодаря эмалированным краям с 4 сторон, которые гарантируют адаптируемость к любому типу душевой зоны. Что еще более важно, благодаря смеси, разработанной в лабораториях Hatria, душевой поддон Petra_H3 Ardesia можно уменьшить, поэтому его можно обрезать по размеру, чтобы легко приспособить к любому проекту ванной комнаты. Дополнительная ценность, которая переводит стиль одежды, типичный для Made in Italy, на язык керамики, давая жизнь линейке универсальных, простых в установке душевых поддонов, которые становятся главным героем ванной комнаты благодаря дизайну, сочетающему в себе последние тенденции в дизайн интерьера.



01

NERO / BLACK

01: PETRA H3_ARDESIA GRIGLIA INOX NERA 140x80 PERSONALIZZATO

01: PETRA H3_Ardesia 140x80 customized with stainless steel black square cover



PERSONALIZZATO Customized

Grazie alla sua facilità di taglio, è possibile adattare il piatto per misure speciali salvando colonne, muretti o angoli esistenti all'interno della casa.

Thanks to its ease of cutting, the shower tray can be adapted to special sizes to save existing columns, low wall or corners inside the house.

Das Material lässt sich leicht zuschneiden, die Duschplatte kann so auch an besondere Maße angepasst werden, auf diese Weise können bereits bestehende Säulen oder Ecken beibehalten werden.

Grâce à sa facilité de coupe, il est possible d'adapter le receveur à des dimensions spéciales en conservant les colonnes, muret ou les angles qui existent déjà à l'intérieur de la maison.

Gracias a la facilidad de corte, es posible adaptar el plato de ducha a medidas especiales, sin modificar columnas, murete o esquinas existentes de la casa.

Благодаря легкости обрезки поддон может быть адаптирован к особым размерам, что позволяет сохранять целыми колонны, низкая стена или углы, существующие в помещении.

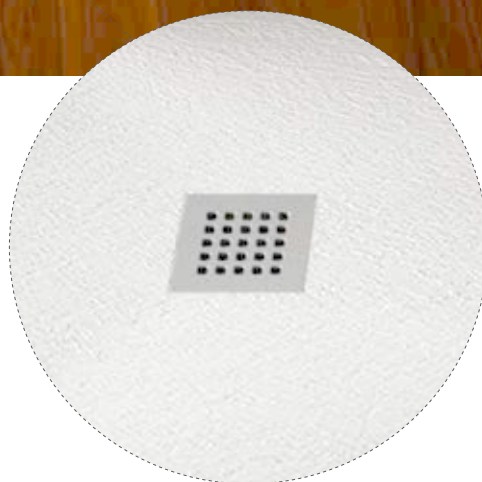

BIANCO / WHITE

02: PETRA H3_ARDESIA GRIGLIA BIANCA / GRIGLIA INOX 120x70

02: PETRA H3_Ardesia 120x70 with stainless steel / white square cover



03

CEMENTO / CEMENT

03: PETRA H3_ARDESIA GRIGLIA CEMENTO 100x80

02: PETRA H3_Ardesia 100x80 with stainless steel white square cover



04

AVORIO / IVORY

04: PETRA H3_ARDESIA GRIGLIA INOX 140x80

02: *PETRA H3_Ardesia 140x80 with stainless steel square cover*

GAMMA GRIGLIE IN ACCIAIO: INOX E IN TINTA COL PIATTO DOCCIA

Color range of the steel grate: stainless steel or colored matching the shower tray
 Farbpalette der Stahlgitter: Edelstahl oder in der gleiche Farbe der Duschwanne
 Palette de couleurs de la grille en acier : acier inoxydable ou colorée comme le receveur de douche
 Gama cromatica de la rejilla en acero: acero inoxidable o colorado a juego del plato de ducha
 Цветовая гамма гриль из стали: нержавеющей сталь или окрашенный в тон душевого поддона

BIANCO / WHITE

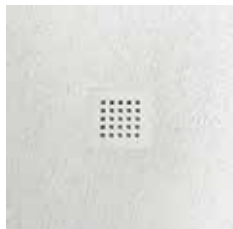

GRIGLIA BIANCO

white grate



GRIGLIA INOX

stainless steel grate

AVORIO / IVORY



GRIGLIA AVORIO

ivory grate



GRIGLIA INOX

stainless steel grate

CEMENTO / CEMENT

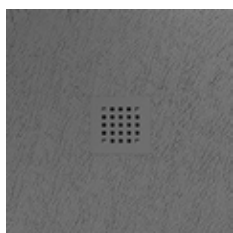

GRIGLIA CEMENTO

cement grate



GRIGLIA INOX

stainless steel grate

NERO / BLACK



GRIGLIA NERO

black grate



GRIGLIA INOX

stainless steel grate



LIF shower trays H3

L'INNOVAZIONE DELL'ELEGANZA E DELLA LEGGEREZZA
INNOVATION OF ELEGANCE AND LIGHTNESS



I piatti doccia LIF H3 di soli 3 cm di altezza rivoluzionano l'ambiente bagno in un vero e proprio spazio dove l'estetica e la funzionalità si sposano in modo armonico. La rivoluzionaria tecnologia sviluppata negli stabilimenti Hatria consente infatti di ottenere una qualità non paragonabile e una maggiore definizione dei dettagli rispetto alle attuali tecnologie in commercio, conferendo al prodotto un design dall'aspetto ultramoderno. Dalla combinazione tra materiale ceramico ed know-how d'avanguardia si ottiene la completa planarità del piatto su lunghezze sino a 140 cm coniugata alla leggerezza, proiettando così la collezione in una dimensione unica nel panorama mondiale. La piletta tonda ispezionabile con coperchio ultrapiatto integra e rafforza le caratteristiche di unicità di questo prodotto ceramico. Installabili sia a filo pavimento che in appoggio.

The shower trays H3 in ceramic only 3 centimeters high make a revolution inside the bathroom creating a new space coupling design and functionality in harmony.

The brand new technology developed by Hatria allows a quality without comparison and a better definition of the details and last but not least a very trendy design.

With the combination of ceramic material with advanced know-how we reach a complete flat, slim and light solution up to 140 centimeters. This creates a new chapter in the story of this product in a worldwide point of view.

The drain with a slim cover completes the unique and specific details of this product.

Can be floor-mounted or built-in.

Die Duschwanne H3 in Keramik nur 3 Zentimeter hoch machen eine Revolution im Inneren des Badezimmers, die machte eine neue Raumkupplung Design und Funktionalität mit Harmonie. Die ganz neue Technologie, die von Hatria entwickelt wurde, ermöglicht eine Qualität ohne Vergleich und eine bessere Definition der Details und doch ein sehr trendiges Design. Durch die Kombination von Keramikmaterial mit fortgeschrittenem Know-how erreichen wir eine komplette Flach-, Schlankheits- und Lichtlösung bis zu 140 Zentimetern. Damit wird ein neues Kapitel in der Geschichte dieses Produktes in weltweiter Sicht aufgeschlagen. Der Abfluss mit schlanker Abdeckung rundet die einzigartigen und spezifischen Details dieses Produktes komplett ab. Bodenebene Installation oder Aufsatz.

Les plateaux de douche en céramique H3 avec une hauteur de seulement 3 centimètres permettent de coupler l'esthétique avec la pratique de façon harmonieuse. Une nouvelle technologie à haute pression développée par Hatria permet une qualité incomparable et une majeure définition des détails par rapports aux technologies actuellement dans le commerce, conférant au produit un aspect moderne et tendance. La combinaison entre savoir-faire et matériel céramique permet une surface plane jusqu'à 140 centimètres ainsi qu'un produit léger, créant ainsi une nouvelle dimension de produit dans le panel mondial. La bonde ronde et démontable avec un couvercle ultra-plat intègre et renforce les caractéristiques uniques de ce produit. Peut être installé à ras du sol ou en appui.

Los platos de ducha H3 en cerámica de sólo 3 centímetros de altura hacen una revolución dentro el baño creando un nuevo espacio de acoplamiento diseño y funcionalidad en armonía. La nueva tecnología desarrollada por Hatria permite una calidad sin comparación y una mejor definición de los detalles y por último pero no menos importante un diseño muy de moda. Con la combinación de material cerámico con conocimientos avanzados llegamos a una solución completa plana, delgada y ligera de hasta 140 centímetros. Esto crea un nuevo capítulo en la historia de este producto en un punto de vista mundial. El desagüe con una cubierta delgada completa completamente los detalles únicos y específicos de este producto. Instalación contra el pavimento o apoyado al mismo.

3 см душевые поддоны сочетают эстетику и функциональность. Часть остается плоской завершения до 140 дюйма шириной. Это легкий, хотя керамика. Это абсолютная новизна для этого типа продукта. Слив с ультра-плоской крышкой. Устанавливаемая заподлицо с полом или заземлением-поддержка.

h 3 cm

LIF H3 shower trays

L'INNOVAZIONE DELL'ELEGANZA E DELLA LEGGEREZZA

Innovation of elegance and lightness
 Innovation im Eleganz und Lichtkeit
 L'innovation de l'élégance et de la légèreté
 La innovación de la elegancia y la ligereza
 Инновация элегантности и легкости



1400x800



1200x800



1000x800



1400x700



1200x700



1000x700



900x700



800x800



01 BIANCO
WHITE



25 BIANCO MATT
WHITE MATT



02 NERO MATT
BLACK MATT



01

01: LIF H3 140x80, VASO + BIDET BEAT

01: LIF H3 140x80, wc + bidet BEAT





03

02-03: LIF H3 120x80

SISTEMI PER
L'ARCHITETTURA /
GRANDI CLASSICI

SYSTEMS FOR ARCHITECTURE / GREAT CLASSICS



ABITO

UN NUOVO ABITO PER IL BAGNO CONTEMPORANEO
A NEW OUTFIT FOR THE CONTEMPORARY BATHROOM



Il design della forma incontra l'eccellenza di una tradizione ceramica che mantiene viva la ricerca estetica e l'innovazione tecnologica. Da qui nasce una rivoluzionario concetto che rende i sanitari veri e propri complementi di arredo da integrare con versatilità e leggerezza a qualsiasi ambiente bagno. Un sistema sofisticato, ma semplice nell'utilizzo, permette di sostituire la carena di vaso e bidet scegliendo tra una gamma selezionata di colori, studiati per adattarsi a stili differenti che lasciano libero spazio alla creatività di ognuno, per costruire il proprio bagno ideale.

Finely designed forms meet the excellence of a vibrant ceramics tradition of exciting styling and technological innovation. The result is a revolutionary concept that makes sanitary fittings genuine interior design features, that blend into any bathroom with versatility and lightness of touch. A sophisticated but user-friendly system allows the casings of WCs and bidets to be replaced, with a choice from an exquisite range of colours, selected to suit different styles and give everyone the creative freedom to build up their own ideal bathroom.

Formschönes Design trifft auf erstklassige keramische Tradition, die Ästhetik und HighTech in den Mittelpunkt stellt. Daraus entsteht ein bahnbrechendes Konzept, das Sanitäreinrichtungen zu regelrechten Einrichtungsobjekten avancieren lässt, die sich durch ihre Vielseitigkeit leicht in jedes Badezimmer einfügen. Ein raffiniertes System ermöglicht es, WC- und Bidetverkleidungen einfach und problemlos zu erneuern. Die ausgesuchte Palette an reizvollen Farben bietet für jeden Stil das Richtige und genügend Gestaltungsfreiraum für das eigene Traumbad.

Le design de la forme épouse l'excellence d'une tradition céramique qui alimente la recherche esthétique et l'innovation technologique. Telles sont les bases d'un concept révolutionnaire qui transforme les sanitaires en véritables accessoires de décoration qui s'inscrivent, en douceur et en légèreté, dans tous les types de salles de bains. Un système sophistiqué, mais simple à utiliser, permet de remplacer le carénage de la cuvette et du bidet. Les couleurs élégantes ont été mises au point pour s'adapter à des styles multiples et laisser ainsi libre cours à la créativité personnelle afin de composer la salle de bains idéale.

El diseño de la forma se alía con la excelencia de una tradición cerámica que mantiene vivas la búsqueda estética y la innovación tecnológica. De ahí nace un concepto revolucionario que convierte los sanitarios en verdaderos complementos decorativos que integrar con versatilidad y ligereza en el espacio del baño. Un sistema sofisticado, pero de uso sencillo, permite substituir la carena del inodoro y el bidet eligiendo dentro de una gama selecta de refinados colores, estudiados para adecuarse a diferentes estilos; de este modo, se deja campo abierto a la expresión personal de la creatividad para que cada uno construya su baño ideal.

Дизайнерские формы сливаются с совершенством керамических традиций, продолжая эстетические исследования и технологическую новизну. Из этих предпосылок рождается революционно новых подход, благодаря которому сантехника становится самым настоящим предметом оформления, легко и универсально вписывающимся в интерьер любой ванной комнаты. Изысканная, но простая в применении система позволяет заменить наружный корпус унитаза и биде, выбирая их из тщательно продуманного ассортимента цветов, созданного с тем, чтобы удовлетворять разные стили и оставлять место индивидуальному творчеству в подборе идеальной ванной комнаты.



ABITO UNO STILE SU MISURA

Tailor-made style
Ein Stil nach Maß
Un style sur mesure
Un estilo a medida
Стиль на заказ



1000x555



580x450



580x450



355x560



355x560



355x560



355x560



01 BIANCO
WHITE



25 BIANCO MATT
WHITE MATT

12 AVORIO
IVORY

29 TABACCO
TOBACCO

28 CRETA
CRETE

46 SELVA
FOREST

26 SABBIA
SAND

07 CEMENTO
CEMENT

08 ANTRACITE
ANTHRACITE

45 CENERE
ASH

06 LAVAGNA
BLACKBOARD

02 NERO MATT
BLACK MATT



355x560



LO CAMBIO QUANDO VOGLIO

*Change it when you like
Beliebig wechselbar
Je le change quand je veux
Lo cambio cuando quiera
Могy поменять его, когда захочу*

LO SCELGO ANCHE DOPO

*Add it later if you choose
Auch nachträglich auswählbar
Je peux aussi le choisir après
Lo elijo incluso después de la instalación
Могy выбрать его позже*

LO SOSTITUISCO DA SOLO

*Replace it yourself
Eigenhändig austauschbar
Je le remplace tout seul
Lo pongo yo mismo
Могy заменить его самостоятельно*



CEMENTO / CEMENT

01: LAVABO 58 D'APPOGGIO

TABACCO / TOBACCO

02: LAVABO 58 D'APPOGGIO

01-02: *surface-mounted washbasin 58*



03



04



05

AVORIO / IVORY

03: LAVABO 58 D'APPOGGIO

NERO MATT / BLACK MATT

04: LAVABO 58 D'APPOGGIO

05: VASO + BIDET SOSPESI

03-04: *surface-mounted washbasin 58*

05: *wall hung wc + bidet*



G-FULL

SPAZIO, TEMPO E FUNZIONI SI FONDONO IN UN NUOVO COMFORT
SPACE, TIME AND FUNCTIONALITY BLEND TOGETHER TO CREATE A NEW CONCEPT IN COMFORT



G-FULL è un sistema di sanitari integrato e polifunzionale: un unico piano in ceramica che si trasforma in una comoda panca o in un ampio piano d'appoggio.

G-FULL is a multipurpose bench system with integrated toilet and bidet: a single element, concealed under a cover that provides space for wellbeing.

G-FULL ist ein funktionales Sanitär System und integriert: ein einzelne keramische Fläche, die sich in eine einzige keramische Form entwickeln mit einer bequeme Sitzbank mit einer grosse Auflagefläche.

G-FULL est un système de sanitaires intégré multifonction : une surface unique en céramique qui se transforme en un banc pratique ou en une grande surface d'appui.

G-FULL es un sistema de sanitarios integrado y multifuncional, una superficie única de cerámica se transforma en un cómodo banco o en una amplia encimera de apoyo.

G-FULL – это многофункциональная интегрированная система сантехники: сплошная керамическая поверхность трансформируется в удобную скамью или просторную опорную плоскость.



G-FULL

UN UNICO ELEMENTO RACCHIUSO DA UNA COPERTURA CHE DIVENTA SPAZIO PER IL BENESSERE

A single element, concealed under a cover that provides space for wellbeing
Ein einzelne keramische Fläche, die sich in eine einzige keramische Form entwickeln mit einer bequeme Sitzbank mit einer grosse Auflagefläche
Une surface unique en céramique qui se transforme en un banc pratique ou en une grande surface d'appui
Superficie única de cerámica se transforma en un cómodo banco o en una amplia encimera de apoyo
Сплошная керамическая поверхность трансформируется в удобную скамью или просторную опорную плоскость



140 1415x500 dx-rh
120 1200x500 dx-rh



140 1415x500 sx-lt
120 1200x500 sx-lt



120 1200x500 dx-rh



120 1200x500 sx-lt



480x400x440h



01 BIANCO
WHITE





03-04: G-FULL 140 VASO A SINISTRA COPERTURA IROKO
05: G-FULL 120 VASO A DESTRA, PILOZZO

*03-04: G-Full 140 wc left wood iroko cover
05: G-Full 120 wc right, sink*



06

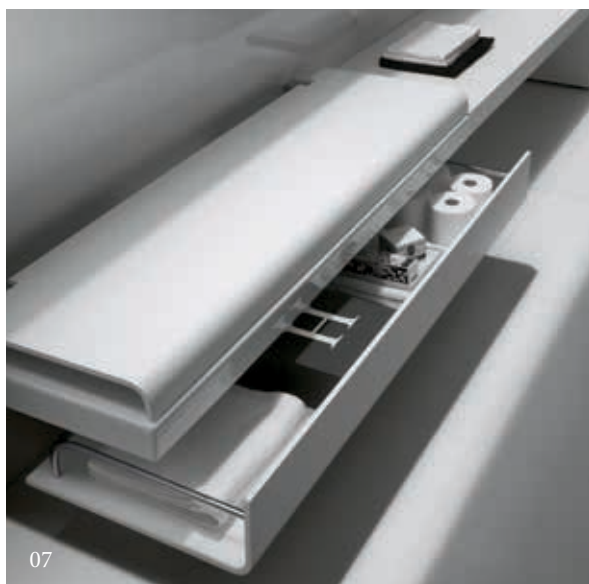

07

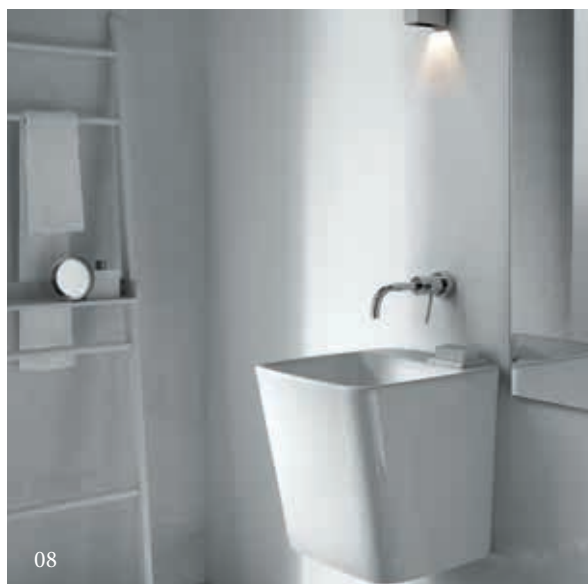

08

06: G-FULL 140 VASO A SINISTRA COPERTURA BIANCA, PANCA AD L, PILOZZI DA APPOGGIO
 07: G-FULL 140 VASO A SINISTRA COPERTURA BIANCA, CASSETTO CONTENITORE
 08: PILOZZO SOSPESO

06: G-Full 140 wc left white cover, L bench, surface mounted sinks.
 07: G-Full 140 wc left white cover, drawer
 08: wall hung sink



YOU & ME

FORME IDEALI PER SPAZI CONTENUTI
IDEAL SHAPES FOR SMALL SPACES



Le ridotte dimensioni di You&Me ne fanno la soluzione ideale per ambienti particolarmente piccoli: ogni singolo elemento risulta funzionale alla costruzione di un bagno completo a partire dall'ingombro minimo di un M².

The reduced dimensions of You&me make it an ideal solution for particularly small areas: every element is functional in the construction of a complete bathroom, starting from the minimum volume of 1 sq. m.

YOU & ME Die kleine Masse sind eine ideale Lösung für ein besonders kleine Raum: jedes Element ist geeignet für dem Bau eines kleinen Badezimmer, auch für einen Raum von nur 1 qm.

Les dimensions réduites de You&Me en font la solution idéale pour des espaces très exigus : chaque élément compose en effet une salle de bain complète à partir de l'encombrement minimum d'un M².

Las medidas reducidas de You&Me lo convierten en la solución ideal para cuartos de baño muy pequeños: cada elemento es funcional a la construcción de un baño completo a partir de la medida mínima de un m².

Уменьшенные размеры сантехники серии You&Me делают ее идеальным решением для малогабаритных помещений: каждый отдельный элемент функционально участвует в создании полностью укомплектованной ванной комнаты даже на площади в 2 кв. метра.



YOU & ME TUTTO IL TUO BAGNO IN UN M²

All your bath in a m²
Alles bad in einem m²
Tout votre bain en m²
Todo tu baño en un m²
Все ваша ванна в м²



460x460 dx-rh



460x460 sx-lt



375x505



01 BIANCO
WHITE





SCULTURE

PROTAGONISTA UN'ELEGANZA SENZA TEMPO
THE PICTURE OF TIMELESS ELEGANCE



Elementi di forte plasticità si accompagnano a linee curve in sottile equilibrio, dando vita a una particolare atmosfera oscillante tra il materico e l'etereo.

Strongly plastic elements appear alongside curved lines in a subtle equilibrium, creating a unique atmosphere midway between the material and the aerial.

Elemente starker Plastizität werden von geschwungenen Linien in subtiler Balance begleitet, die in einer bestimmten Momente eine Atmosphäre im Leben geben und zwischen dem Material und der Ebene schwingen.

Des éléments très plastiques et des lignes courbes en un mince équilibre créent une atmosphère spéciale qui oscille entre la matière et l'aérien.

Los elementos intensamente plásticos se unen a los trazos curvos formando un delicado equilibrio que da vida a un ambiente especial que oscila entre lo material y lo etéreo.

Чрезвычайно пластичные элементы сочетаются с закругленными линиями в тонком равновесии, вдыхая жизнь в особенную атмосферу, колеблющуюся между материальным и воздушным.



SCULTURE UN'ELEGANZA SENZA TEMPO

Timeless elegance
Eine zeitlose eleganz
Une élégance intemporelle
Una elegancia a tiempo
Временное элганес



1100x585



770x585



650x585



690x525



400x600



420x720x820



01 BIANCO
WHITE



01



02

01: LAVABO 110 CON SEMICOLONNA, VASO + BIDET FILO MURO
 02: LAVABO 65 CON SEMICOLONNA, VASO MONOBLOCCO CON CASSETTA

01: washbasin 110 with siphon cover, back to wall wc + bidet
 02: washbasin 65 with siphon cover, coupled wc with cistern



03

03: LAVABO 110 CON SEMICOLONNA

03: washbasin 110 with siphon cover



04



05

04: LAVABO 77 CON SEMICOLONNA
 05: LAVABO 70 D'APPOGGIO

*04: washbasin 77 with siphon cover
 05: surface-mounted washbasin 70*



DOLCEVITA

COMBINAZIONE TRA CLASSICO E CONTEMPORANEO
COMBINATION OF CLASSIC AND CONTEMPORARY



La linea Dolcevita riscopre la classicità come valore che ritorna a vivere nel presente, filtrato dalla tecnologia e da nuove scelte progettuali.

The Dolcevita line rediscovers classical values, giving them new life for the present, filtered through technology and fresh design strategies.

Dolcevita hat eine klassische Form die in der Vergangenheit bringt aber noch heute aktuell ist, und in der heutigen Technologie filtriert ist.

La ligne Dolcevita redécouvre le classique comme valeur qui recommence à vivre dans le présent, filtrée par la technologie et par de nouveaux choix conceptuels.

La línea Dolcevita revive el estilo clásico como valor que regresa al presente, filtrado a través de la tecnología y de unas nuevas posibilidades de diseño.

Линия Dolcevita вновь открывает классичность, как ценность, возвращающуюся к жизни в настоящем, отфильтрованную технологией и новыми проектными выборами.



DOLCEVITA COMBINAZIONE TRA CLASSICO E CONTEMPORANEO

Combination of classic and contemporary
Kombination zwischen classic und zeitgenössisch
Combinaison entre classique et contemporain
Combinación entre clásica y contemporánea комбинация между классическими и современными



1000x550



750x550

750x550

700x550

650x480



370x590



370x710x1005



01 BIANCO
WHITE



01

01: LAVABO 650x480 DA INCASSO

01: built-in washbasin 650x480





04



05



06

02: LAVABO R75 CON COLONNA
 03: LAVABO 100 CON GAMBE
 04: LAVABO 70 CON COLONNA
 05 - 06: VASO CON CASSETTA A ZAINO + BIDET

*02: washbasin R75 with pedestal
 03: washbasin 100 with legs
 04: washbasin 70 with pedestal
 05 - 06: wc with low-level cistern+ bidet*

PROGETTO

SOLUZIONI MODULARI E FLESSIBILI PER IL MONDO PROFESSIONALE
MODULAR AND FLEXIBLE SOLUTION FOR THE PROFESSIONAL WORLD

LAVABI SOSPESI / DA MOBILE / DA APPOGGIO

Suspended / cabinet / Surface-mounted washbasins Hänge- / Möbelwaschbecken / Aufsatz waschbecken Lavabos suspendus / sur meuble / a poser
 Lavabos suspendidos / de mueble / de apoyo Подвесная / со столешницей / умывальники со столешницей

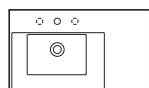

800x465 dx-rh
BAHIA_13

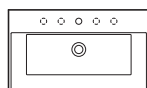

800x465
BAHIA_13

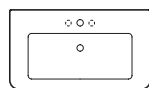

800x450
ERIKA pro

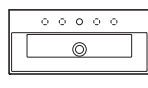

800x365
BAHIA_13

800

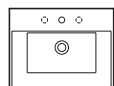

600x465
BAHIA_13

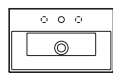

600x365
BAHIA_13

600



500x465
BAHIA_13



500x365
BAHIA_13

500

LAVABI SOSPESI CON COLONNA O SEMICOLONNA

Wall-hung washbasins with full column or siphon cover Hängewaschbecken mit Standsäule oder Halbsäule Lavabos suspendus avec colonne ou demi-colonne
 Lavabos suspendidos con pedestal o semipedestal Раковины подвесные с колонной или полуколонной



640x480
NIDO

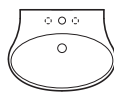

620x470
NIDO

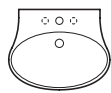

560x445
NIDO

640 / 620 / 560

LAVAMANI

hand-wash Handwaschbecken lave-mains lavamanos рукомойники



450x380
BAHIA_13

450

SPECIALI

special basins Spezialprodukte accessoires spéciaux especiales комплектующие

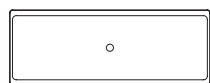

1200x450
905x450
LAVABI A CANALE

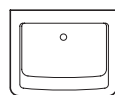

610x500
LAVATOIO

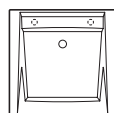

600x600
SIXTY.LP
600x500
FIFTY.LP

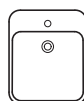

400x480
LAVATOIO
PILOZZO
G-FULL



380x420
LAVATOIO
PILOZZO

LAVABI INCASSO / INCASSO SOTTOPIANO / SEMINCASSO

Built in washbasins / undercounter / half built in Einbauwaschbecken / unterbauwaschtisch / halbeinbau Lavabos à vasque intégrée / sous plan / semi encastré
 Lavabos empotrados / bajo encimera / semientrados Раковины встраиваемые / встраиваемая под столешницу / полувстраиваемый

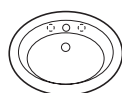

650x480
DOLCEVITA
(INCASSO)



500x380
HAPPY HOUR 11:15
(INCASSO SOTTOPIANO)



500x365
BAHIA_13
(INCASSO SOTTOPIANO)



440x440
HAPPY HOUR 07:15
(INCASSO SOTTOPIANO)



480x480
HAPPY HOUR 09:30
(SEMINCASSO)

PIATTI DOCCIA

Shower Trays Duschwannen Receveurs de douche Platos de ducha Душевые поддоны

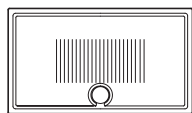

1400x800x30
LIF H3 showertrays h30

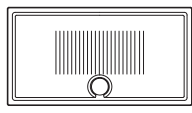

1400x700x30
LIF H3 showertrays h30

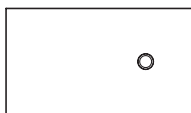

1400x800x30
PETRA_H3 Ardesia

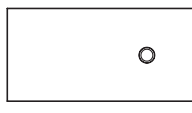

1400x700x30
PETRA_H3 Ardesia

1400

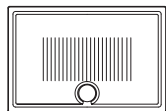

1200x800x30
LIF H3 showertrays h30

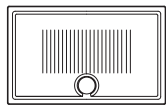

1200x700x30
LIF H3 showertrays h30

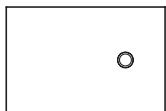

1200x800x30
PETRA_H3 Ardesia

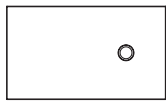

1200x700x30
PETRA_H3 Ardesia

1200

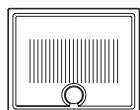

1000x800x30
LIF H3 showertrays h30

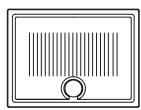

1000x700x30
LIF H showertrays h30

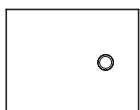

1000x800x30
PETRA_H3 Ardesia

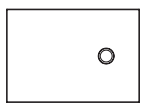

1000x700x30
PETRA_H3 Ardesia

1000

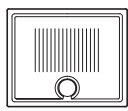

900x700x30
LIF H3 showertrays

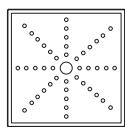

900x900
AUTONOMY

900

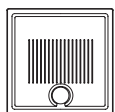

800x800x30
LIF H3 showertrays h30

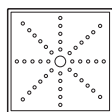

800x800
AUTONOMY

800

VASI E BIDET SOSPESI

Wall-hung WCs and bidets Hängeklosetts und -bidets Cuvettes et bidets suspendus Inodoros y bidés suspendidos Унитазы и биде подвесные

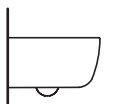
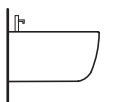
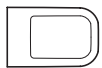

360x520
BIANCA

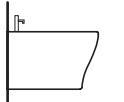

360x520
BEAT

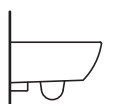
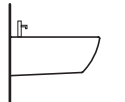

365x550
NIDO

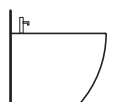
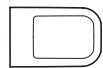

360x520
BIANCA



360x520
BEAT

VASI E BIDET A TERRA

Floor-mounted WCs and bidets Standklosetts und -bidets Cuvettes et bidets au sol Inodoros y bidés de suelo Напольные унитазы и биде

VASI E BIDET A TERRA / VASI CON CASSETTA / MONOLITH

Floor-mounted WCs and bidets / WCs with cisterns / Monolith Standklosetts und -bidets / Klosetts mit Spülkasten / Monolith Cuvettes et bidets au sol / cuvettes avec chasse d'eau / monolith Inodoros y bidés de suelo / inodoros con cisterna / Monolith Напольные унитазаы и биде / унитазаы с бачком для слива / Monolith

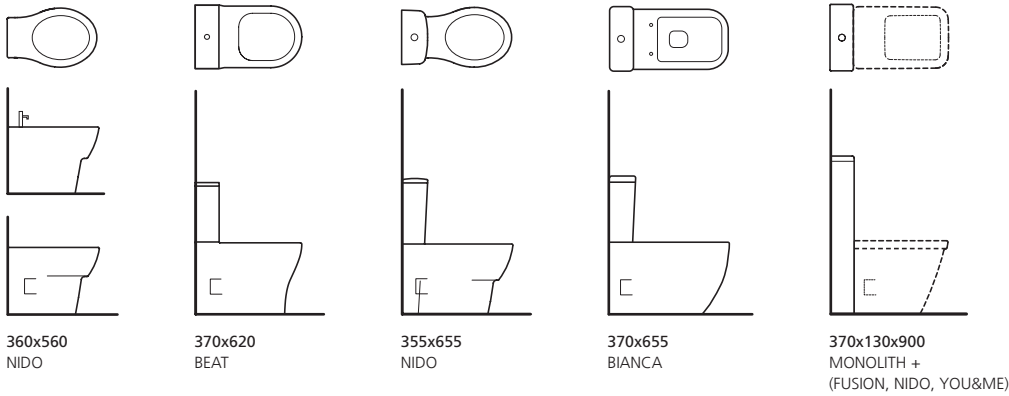

ORINATOIO

Urinal Urinale Urinoir Urinario Писсуары

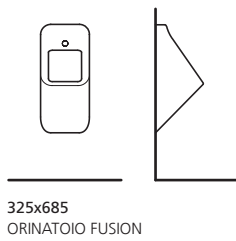

AUTONOMY

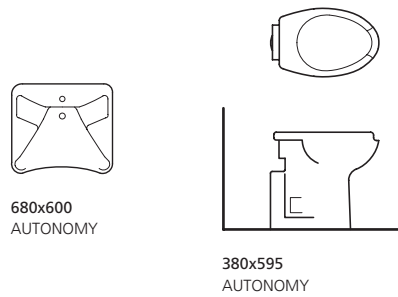

BAGNO 1x1 m

Bathroom 1x1m Bad 1x1m Salle de bain 1x1 m Baño 1x1 m Ванная комната 1x1 м

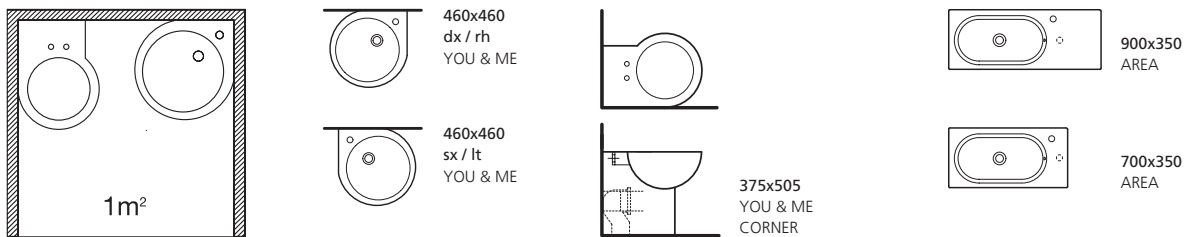



LAVABI INCASSO / SEMINCASSO / INCASSO SOTTOPIANO

- 01: LAVABO INCASSO DOLCEVITA
02: LAVABO SEMINCASSO HAPPY HOUR 09:30
03: LAVABO INCASSO SOTTOPIANO HAPPY HOUR 07:15
04: LAVABO INCASSO SOTTOPIANO HAPPY HOUR 11:15

*01: built in washbasin DOLCEVITA
02: half built in washbasin HAPPY HOUR 09:30
03: built in undercounter washbasin HAPPY HOUR 07:15
04: built in undercounter washbasin HAPPY HOUR 11:15*



01



02



03

LAVAMANI E SPECIALI

- 01: LAVAPANNI FIFTY.LP + MOBILE FIFTY.UNIT
 02: LAVAPANNI SIXTY.LP + MOBILE SIXTY.UNIT
 03: LAVATOI 60 + 38, LAVABO A CANALE 120

*01: laundry sink FIFTY.LP + furniture FIFTY.UNIT
 02: laundry sink SIXTY.LP + furniture SIXTY.UNIT
 03: sinks 60 + 38, sink 120*



01



02



03



04



05



06

VASI E BIDET SOSPESI

- 01: VASO E BIDET SOSPESI NIDO
- 02: VASO E BIDET SOSPESI BIANCA

VASI E BIDET A TERRA

- 03: VASO E BIDET BEAT
- 04: VASO E BIDET NIDO

VASI CON CASSETTA

- 05: VASO MONOBLOCCO BIANCA
- 06: VASO MONOBLOCCO CON CASSETTA NIDO

-
- 01: NIDO wall hung wc and bidet*
 - 02: BIANCA wall hung wc and bidet*
 - 03: wc and bidet BEAT*
 - 04: wc and bidet NIDO*
 - 05: coupled wc BIANCA*
 - 06: coupled wc with cistern NIDO*



01



02



04



05

CASSETTA MONOLITH

- 01: VASO FUSION
- 02: VASO FUSION 48
- 04: VASO NIDO
- 05: VASO BIANCA

-
- 01: wc *FUSION*
 - 02: wc *FUSION 48*
 - 04: wc *NIDO*
 - 05: wc *BIANCA* -



01

BAGNO 1x1 m

01: VASO D'ANGOLO DESTRO YOU & ME + LAVABO YOU & ME 46 ANGOLARE SX

01: corner wc right YOU & ME + corner wasbasin YOU & ME 46 left



01



02



03

AUTONOMY

- 01: LAVABO ERGONOMICO 68 + VASO APERTURA FRONTALE CON SEDILE
- 02: VASO APERTURA FRONTALE CON SEDILE SOLO ANELLO
- 03: VASO APERTURA FRONTALE CON SEDILE IN METACRILATO

*01: ergonomic washbasin 68 + front opening wc with seat cover
 02: front opening wc with only front opening seat cover
 03: front opening wc with acrylic seat cover*

SCHEDE TECNICHE

TECHNICAL SHEETS

BAHIA_13

lavabo 100x46,5
washbasin 100x46,5

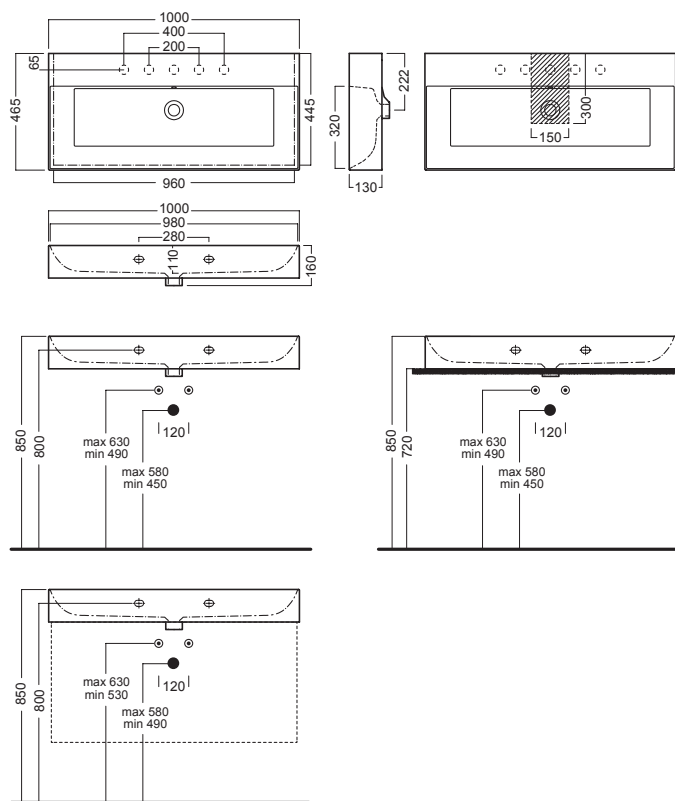

lavabo 80x46,5 destro
washbasin 80x46,5 right

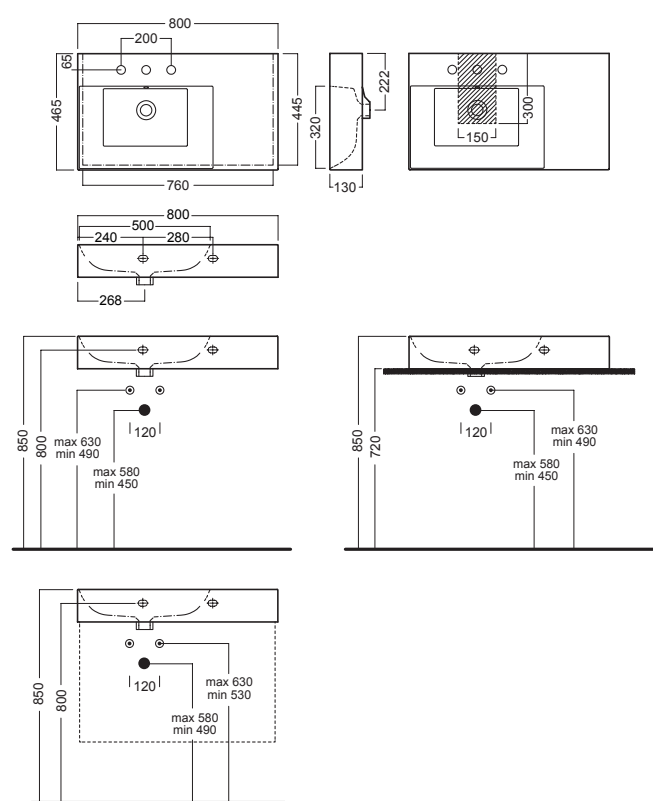

lavabo 80x46,5
washbasin 80x46,5

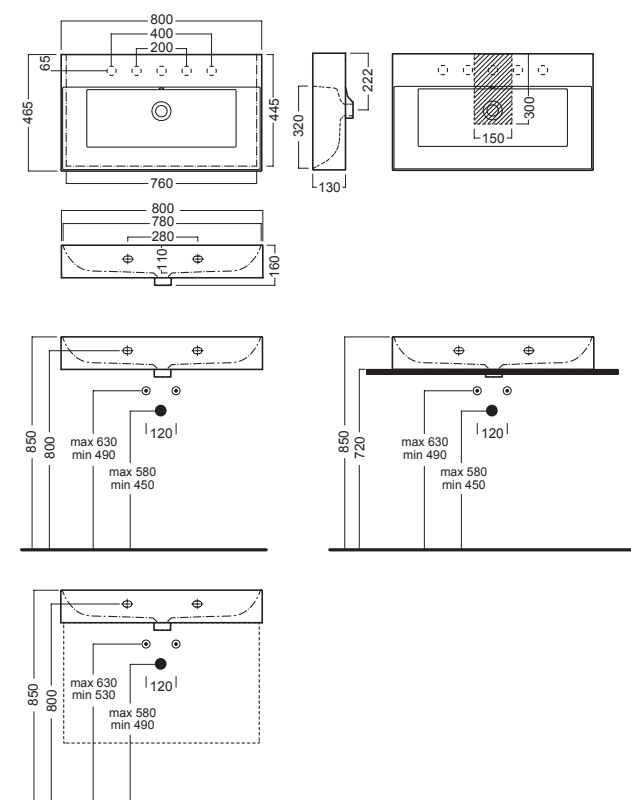

lavabo 80x36,5
washbasin 80x36,5

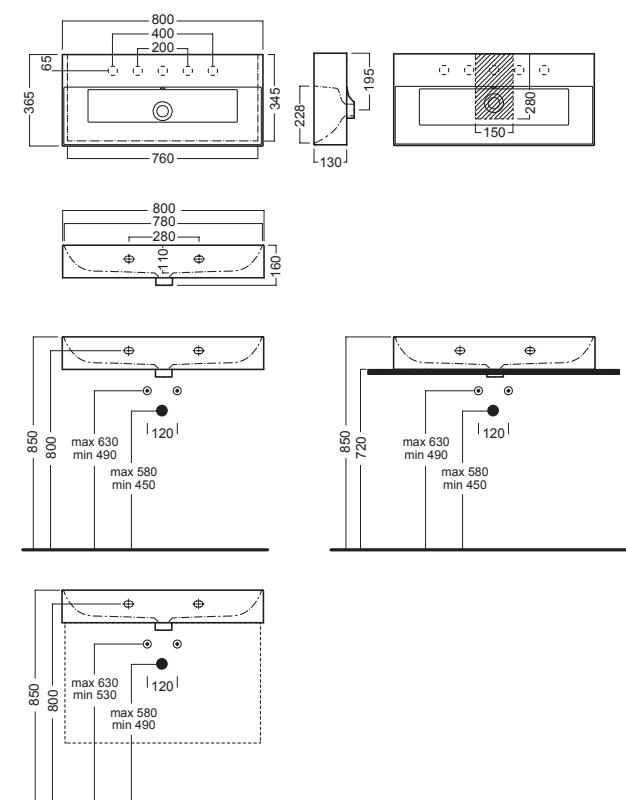

BAHIA_13

lavabo 60x46,5
washbasin 60x46,5

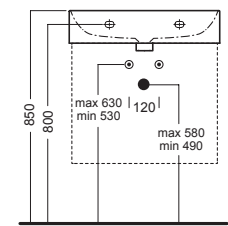
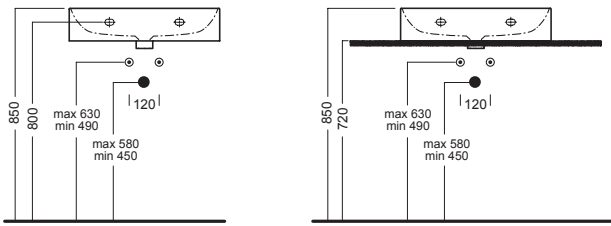
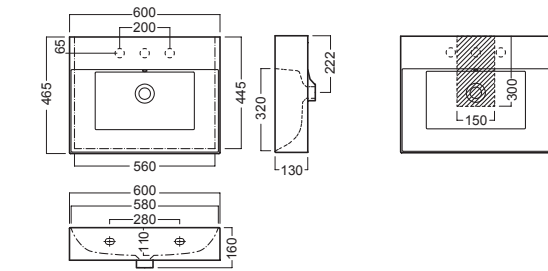

lavabo 60x36,5
washbasin 60x36,5

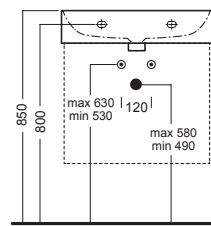
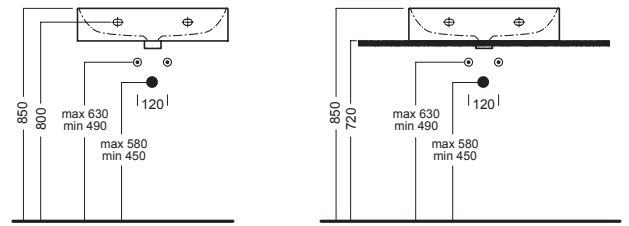
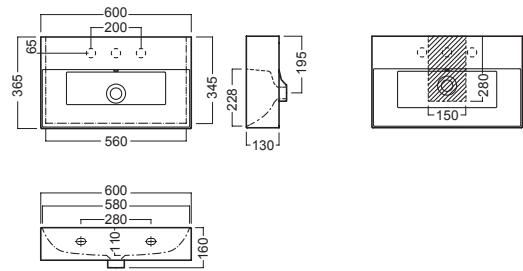

lavabo 50x46,5
washbasin 50x46,5

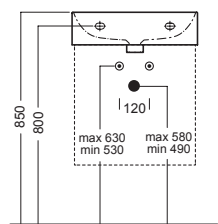
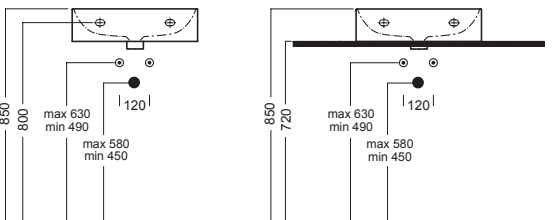
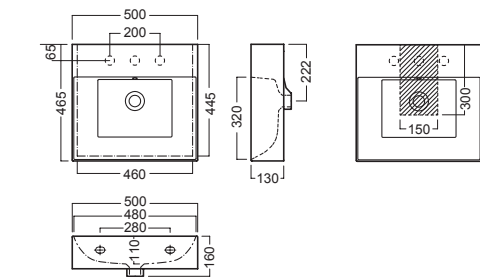

lavabo 50x36,5
washbasin 50x36,5

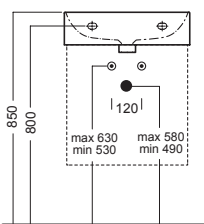
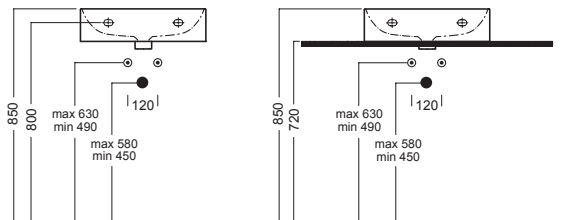
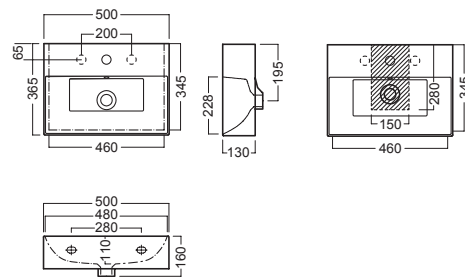

BAHIA_13

lavabo 50x38
washbasin 50x38

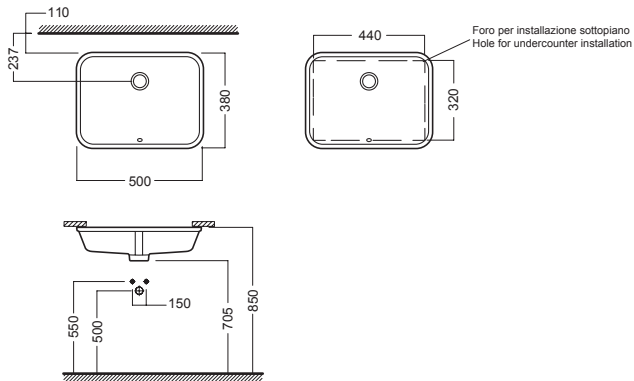

lavamani 45x25
handrinse basins 45x25

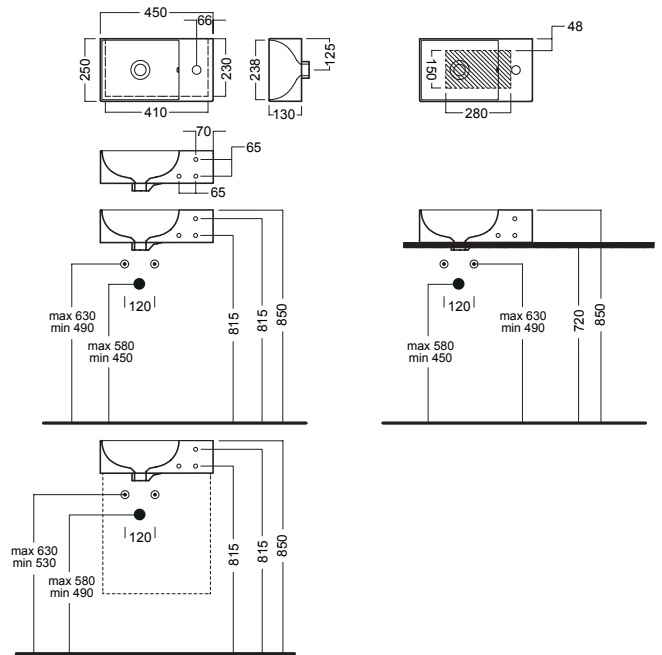

VASCHE FREESTANDING

vasca 170x78
bathtub 170x78

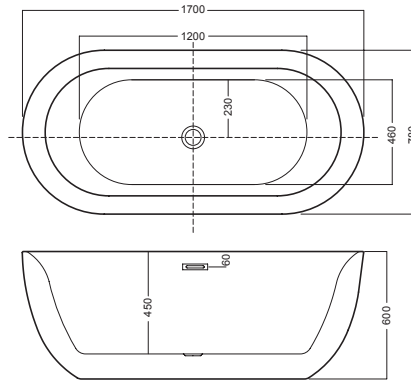

vasca 170x74
bathtub 170x74

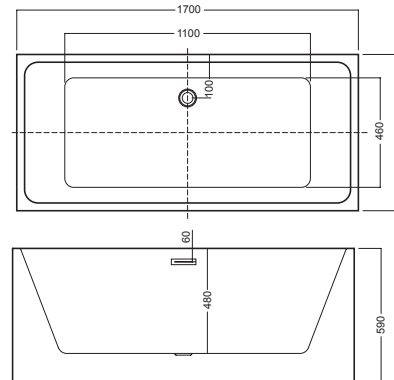

NEXT

vaso sospeso PURE RIM
PURE RIM wall-hung wc

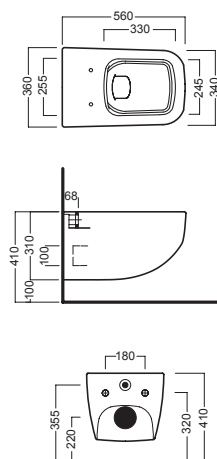

bidet sospeso
wall-hung bidet

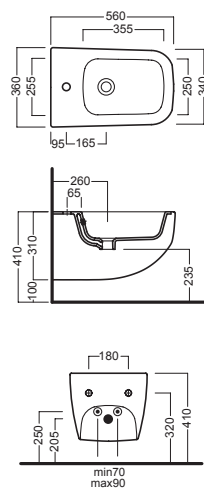

vaso filo muro PURE RIM
PURE RIM back to wall wc

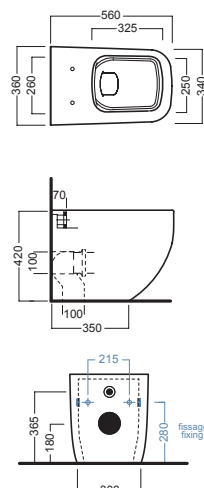

bidet filo muro
back to wall bidet

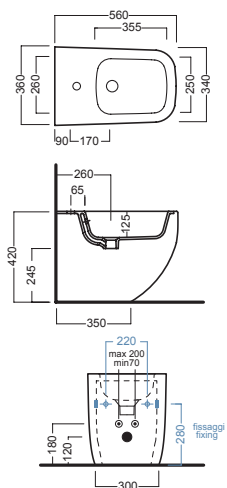

BIANCA

vaso sospeso
wall hung wc

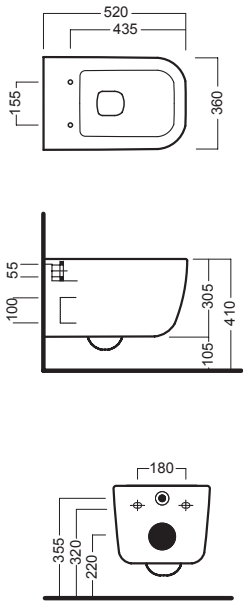

vaso sospeso PURE RIM
PURE RIM wall hung wc

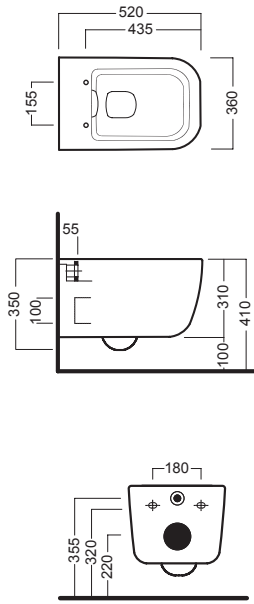

bidet sospeso
wall hung bidet

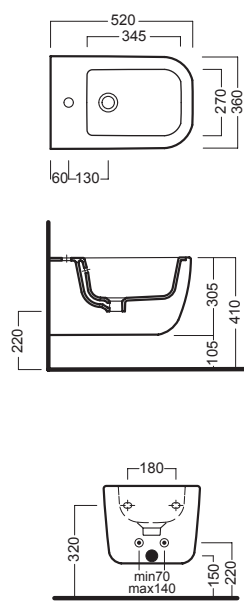

vaso filo muro
back to wall wc

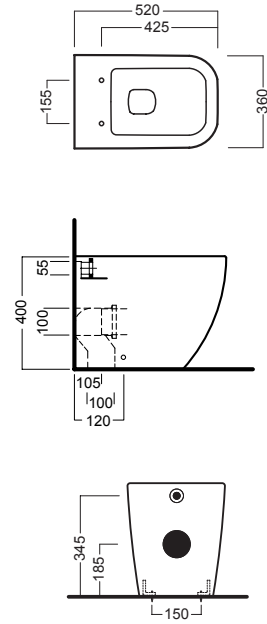

vaso filo muro PURE RIM_SCARICO TRASLATO
PURE RIM back to wall wc_SHIFT DRAIN SYSTEM

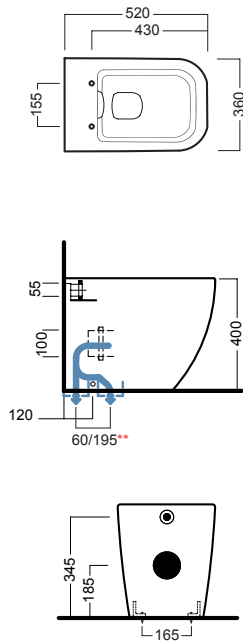

bidet filo muro
back to wall bidet

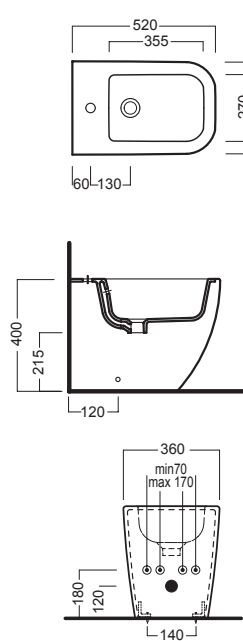

vaso monoblocco con cassetta
coupled wc with cistern

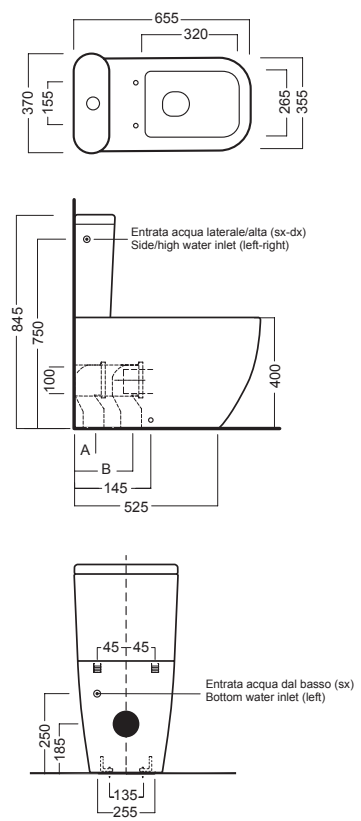

** 215mm Con Raccordo eccentrico per scarico Wc Y1PJ
215mm With eccentric pipe for wc outlet Y1PJ

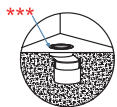

*** Raccordo eccentrico per scarico Wc Y1PJ
Y1PJ Da installare a filo pavimento
Eccentric pipe for Wc outlet Y1PJ
Y1PJ To be installed floor level

FUSION

vaso sospeso PURE RIM
PURE RIM wall hung wc

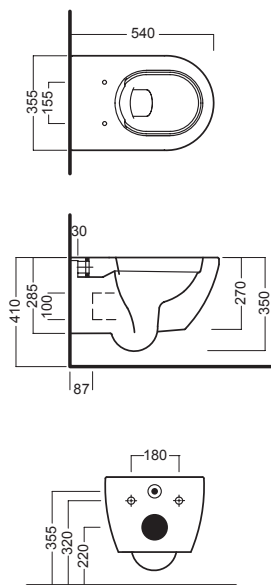

bidet sospeso
wall hung bidet

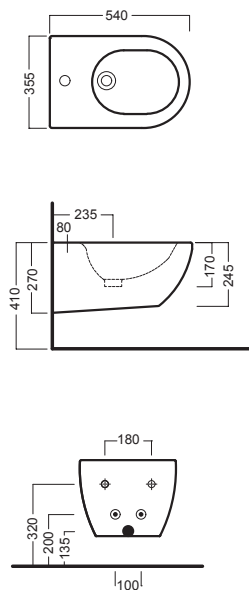

vaso filo muro PURE RIM
PURE RIM back to wall wc

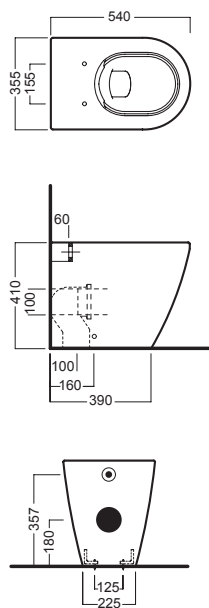

bidet filo muro
back to wall bidet

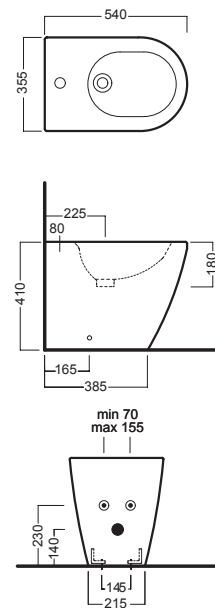

vaso PURE RIM monoblocco con cassetta
PURE RIM coupled wc with cistern

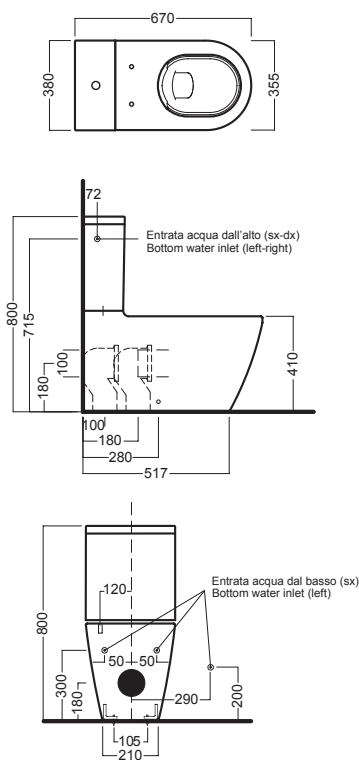

orinatoio sospeso
wall hung urinal

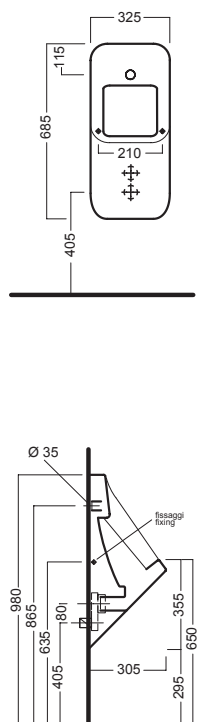

orinatoio sospeso con coperchio
wall hung urinal with cover

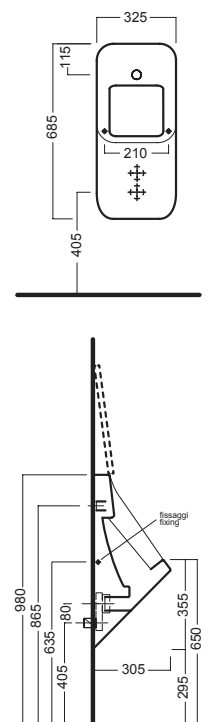

FUSION 48

vaso sospeso
wall hung wc

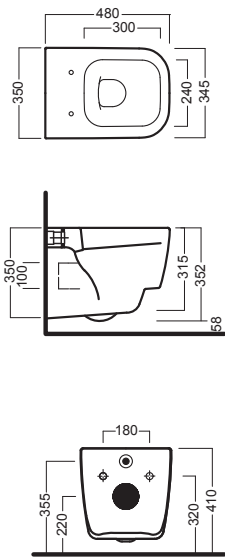

bidet sospeso
wall hung bidet

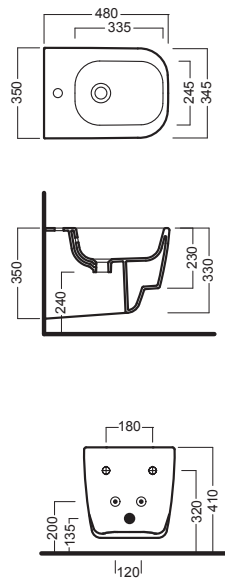

vaso filo muro
back to wall wc

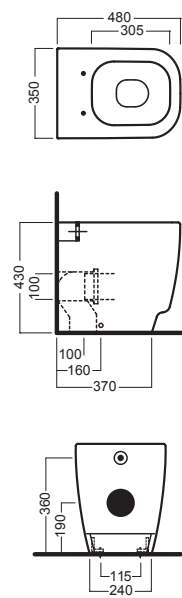

bidet filo muro
back to wall bidet

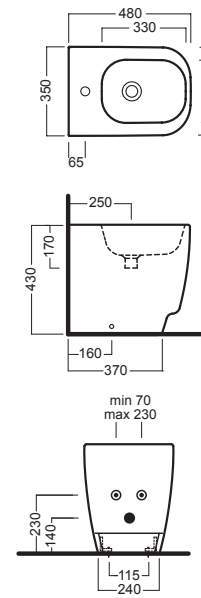

FUSION COMPACT

vaso sospeso PURE RIM
PURE RIM wall hung wc

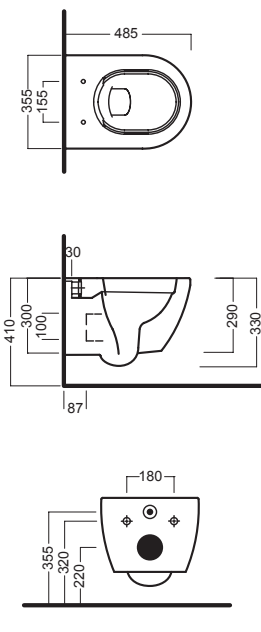

bidet sospeso
wall hung bidet

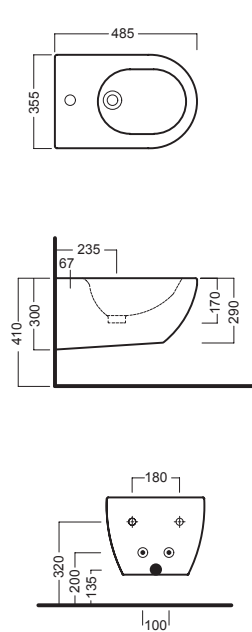

vaso sospeso
wall hung wc

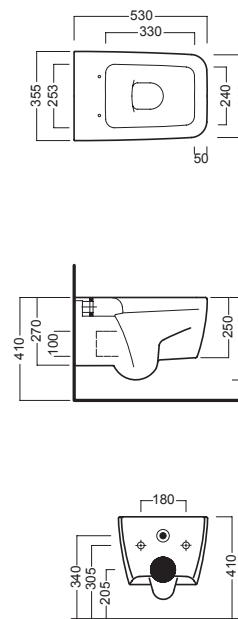

bidet sospeso
wall hung bidet

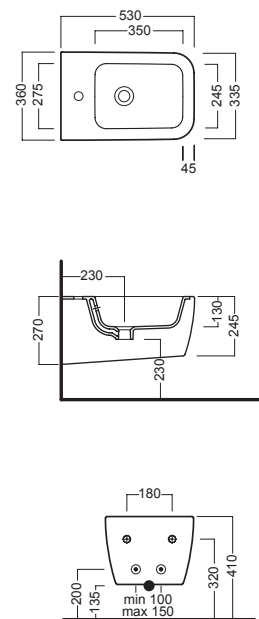

BEAT

vaso sospeso
wall hung wc

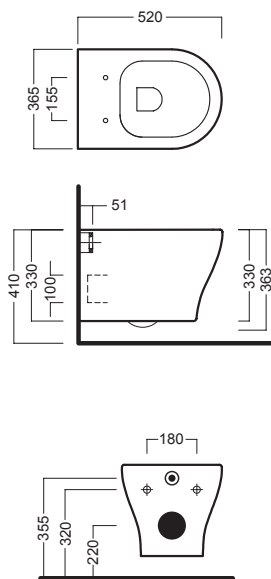

vaso sospeso PURE RIM
PURE RIM wall hung wc

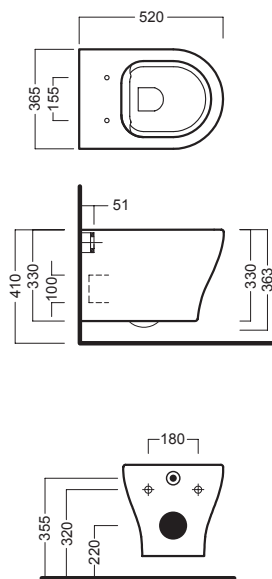

bidet sospeso
wall hung bidet

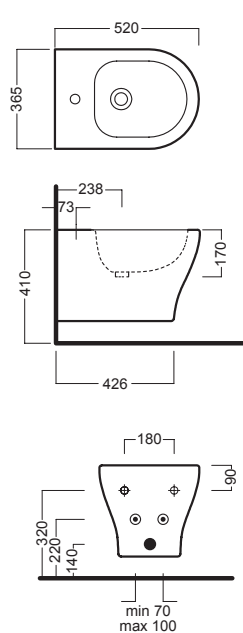

vaso filo muro
back to wall wc

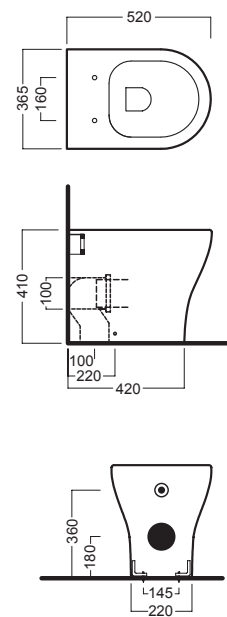

vaso filo muro PURE RIM
PURE RIM back to wall wc

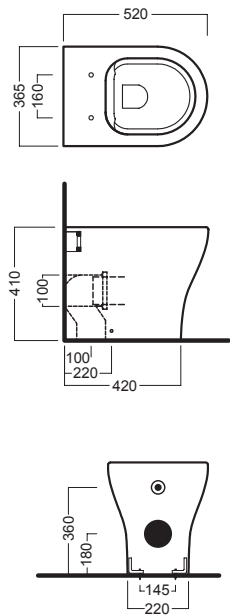

bidet filo muro
back to wall bidet

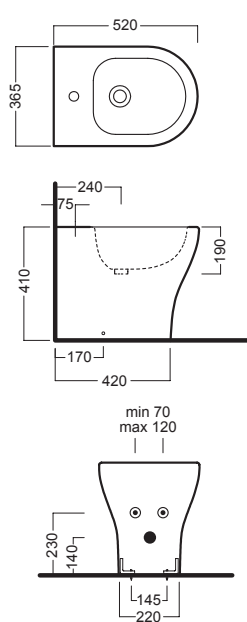

LE FIABE

lavabo 100
washbasin 100

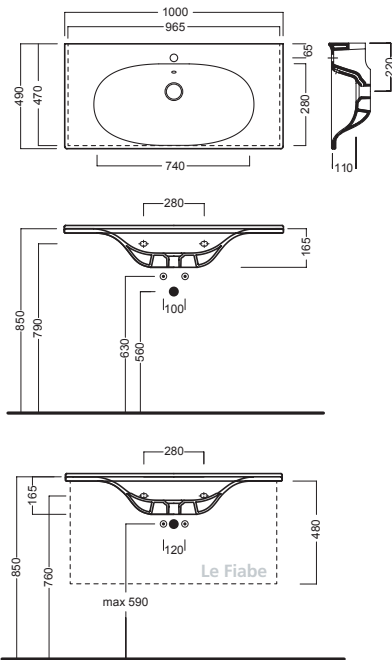

con sifone salvaspazio - with space saver trap_Y1M5

lavabo 80
washbasin 80

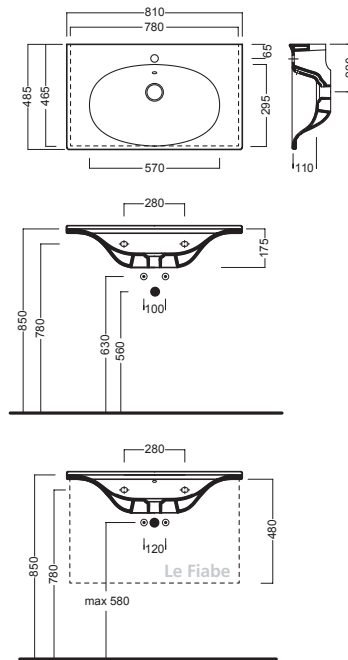

con sifone salvaspazio - with space saver trap_Y1M5

lavabo 60
washbasin 60

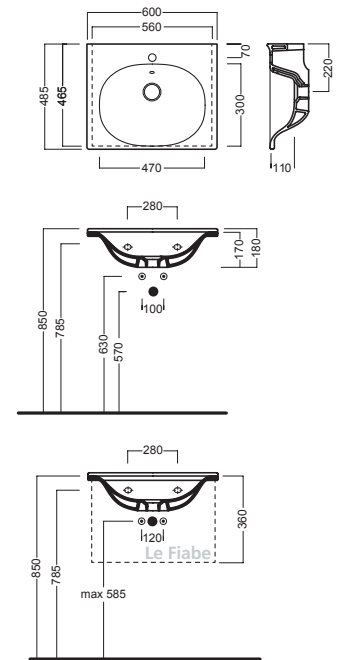

con sifone salvaspazio - with space saver trap_Y1M5

vaso sospeso
wall hung wc

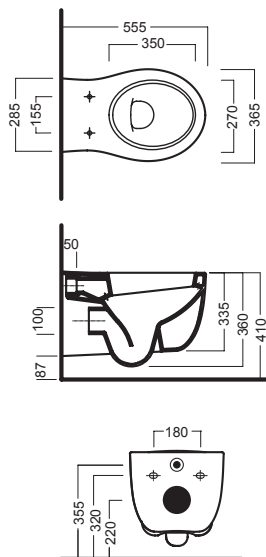

bidet sospeso
wall hung bidet

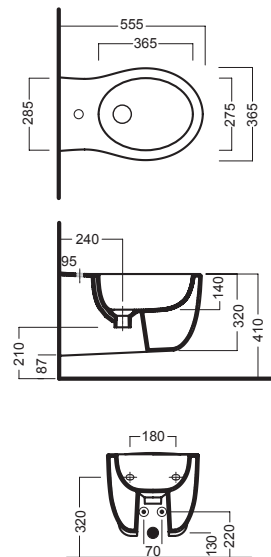

vaso sospeso PURE RIM
PURE RIM wall hung wc

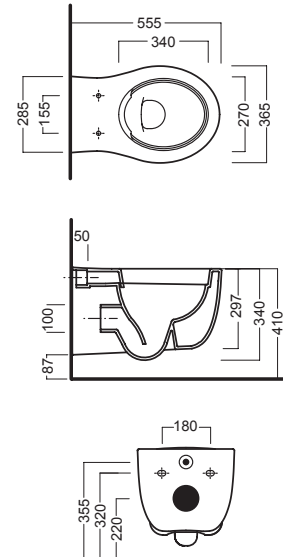

LE FIABE

vaso filo muro PURE RIM
PURE RIM back to wall wc

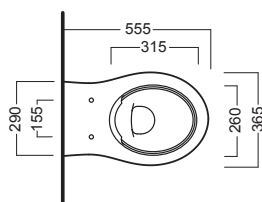

bidet filo muro_OPEN BIDET
back to wall bidet_OPEN BIDET

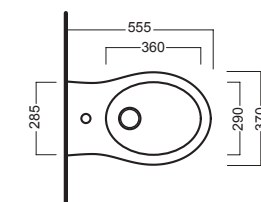

vaso filo muro_SCARICO TRASLATO
back to wall wc_SHIFT DRAIN SYSTEM

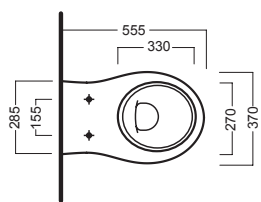

vaso monoblocco PURE RIM
PURE RIM coupled wc

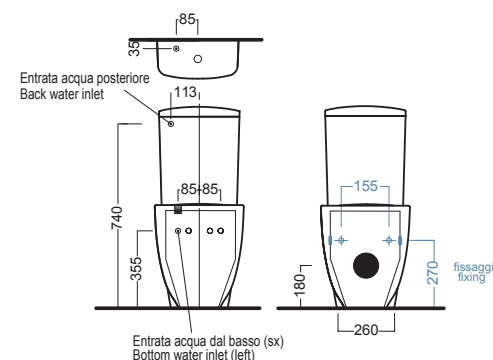
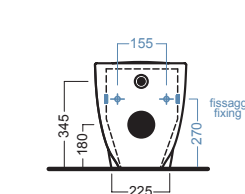
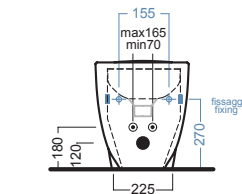
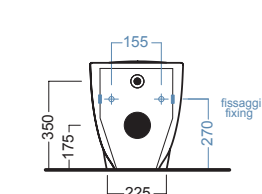
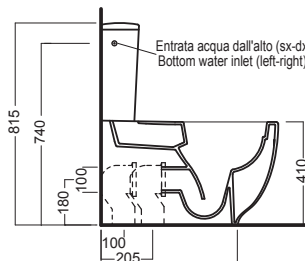
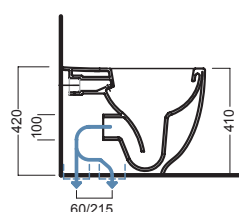
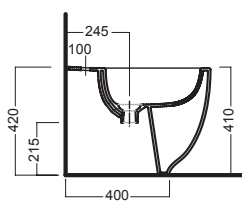
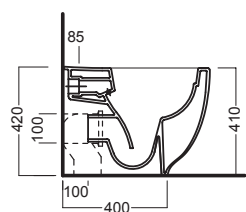
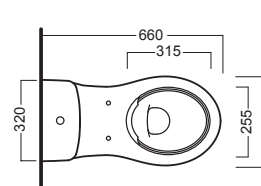

LE FIABE 50

vaso sospeso_50
wall hung wc_50

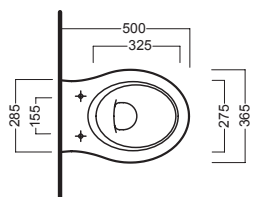

bidet sospeso_50
wall hung bidet_50

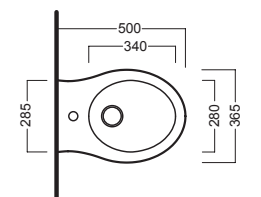

vaso filo muro_50
back to wall wc_50

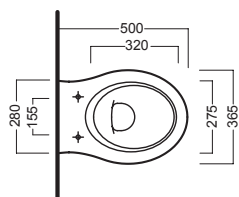

bidet filo muro_50
back to wall bidet_50

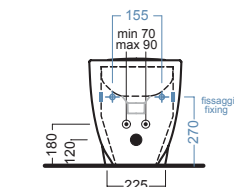
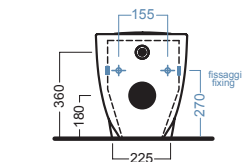
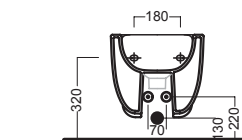
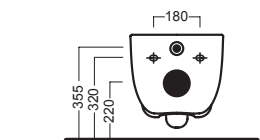
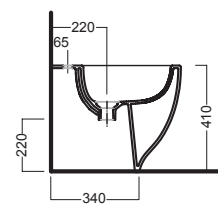
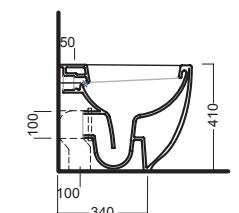
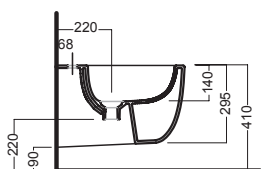
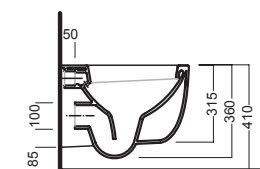
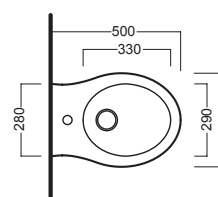

HAPPY HOUR SLIM

lavabo 05:00s
washbasin 05:00s

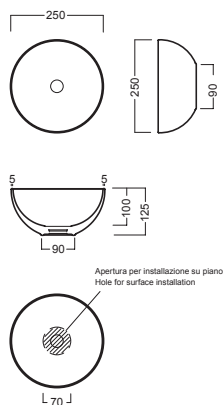

lavabo 06:00s
washbasin 06:00s

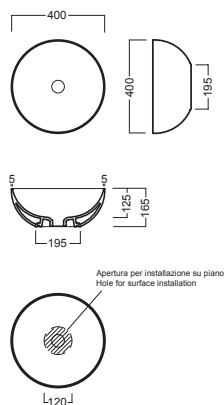

lavabo 07:00s
washbasin 07:00s

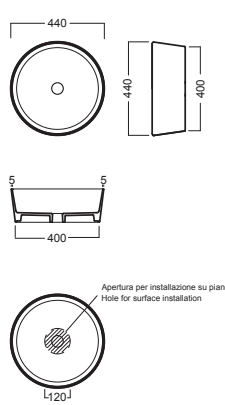

lavabo 11:00s
washbasin 11:00s

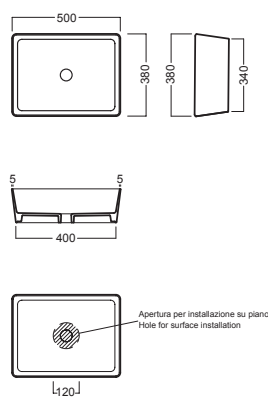

lavabo 18:00s
washbasin 18:00s

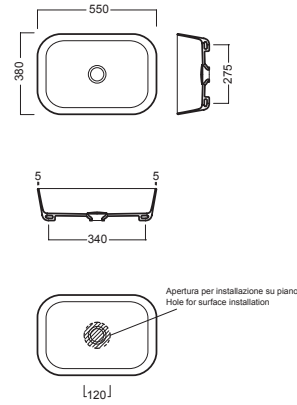

HAPPY HOUR

lavabo 02:00
washbasin 02:00

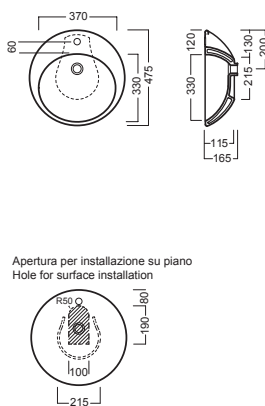

lavabo 03:00
washbasin 03:00

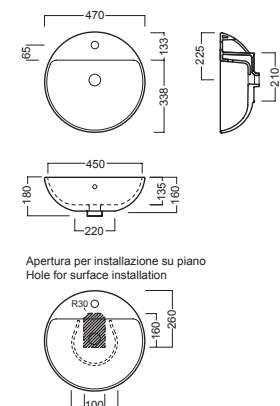

lavabo 07:00
washbasin 07:00

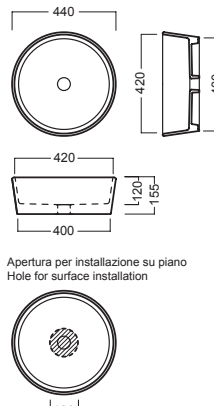

lavabo 07:15
washbasin 07:00

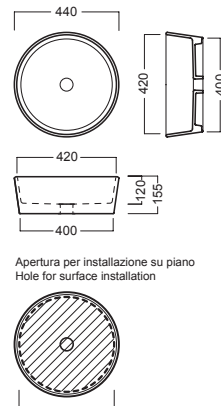

lavabo 09:00
washbasin 09:00

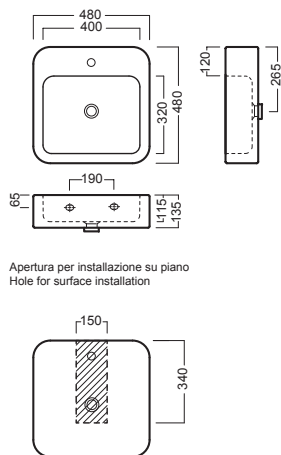

lavabo 09:30
washbasin 09:30

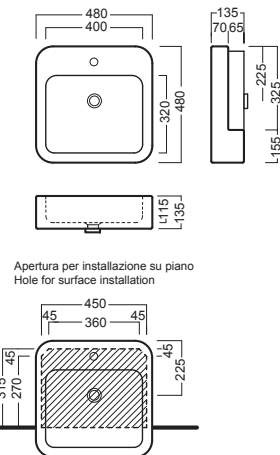

lavabo 10:00
washbasin 10:00

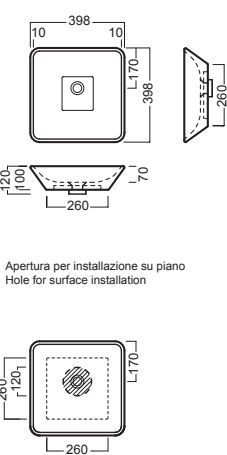

HAPPY HOUR

lavabo 11:00
washbasin 11:00

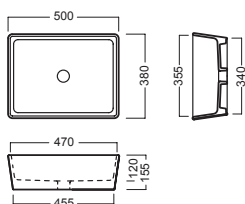

Apertura per installazione su piano
Hole for surface installation

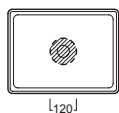

lavabo 11:15
washbasin 11:15

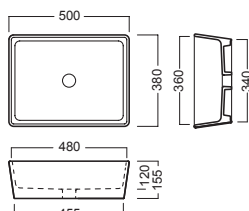

Apertura per installazione su piano
Hole for surface installation

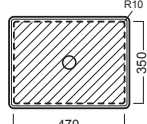

lavabo 17:00
washbasin 17:00

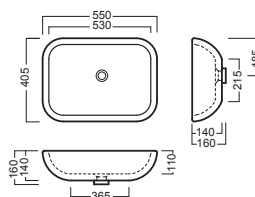

Apertura per installazione su piano
Hole for surface installation

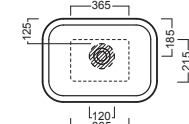

lavabo 22:00
washbasin 22:00

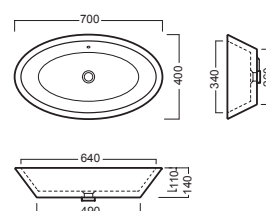

Apertura per installazione su piano
Hole for surface installation

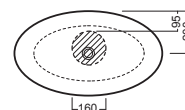

PENCIL

lavabo 55
washbasin 55

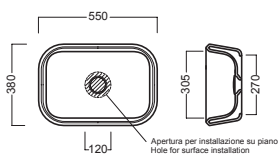

Apertura per installazione su piano
Hole for surface installation

lavabo 40
washbasin 40

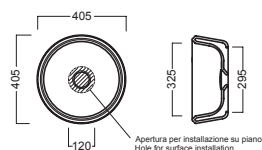

Apertura per installazione su piano
Hole for surface installation

VALLEY

lavabo 60
washbasin 60

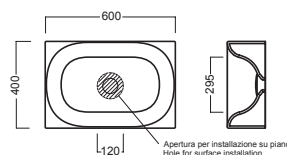

Apertura per installazione su piano
Hole for surface installation

CANALGRANDE

lavabo 100
washbasin 100

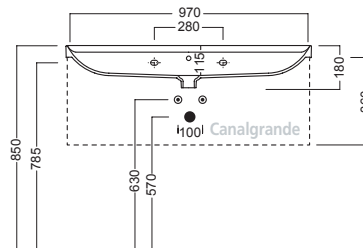
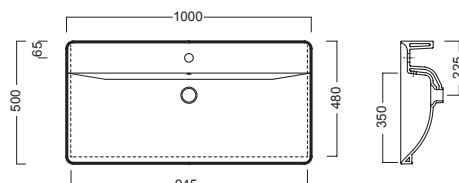

con sifone salvaspazio - with space saver trap_Y1M5

lavabo 80
washbasin 80

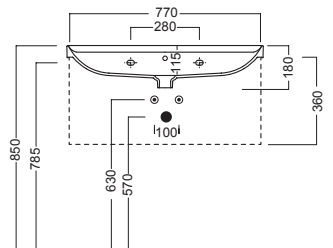
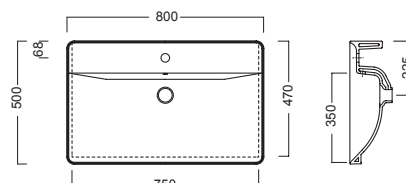

con sifone salvaspazio - with space saver trap_Y1M5

lavabo 60
washbasin 60

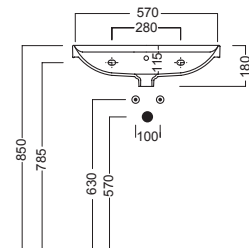
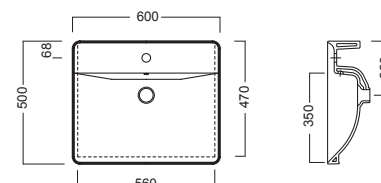

con sifone salvaspazio - with space saver trap_Y1M5

AREA

lavabo 110x35
washbasin 110x35

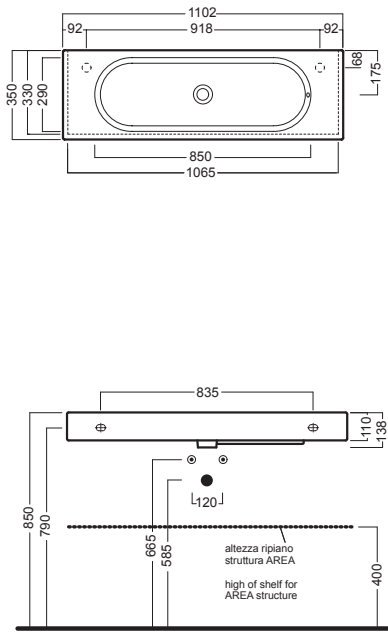

lavabo 90x35
washbasin 90x35

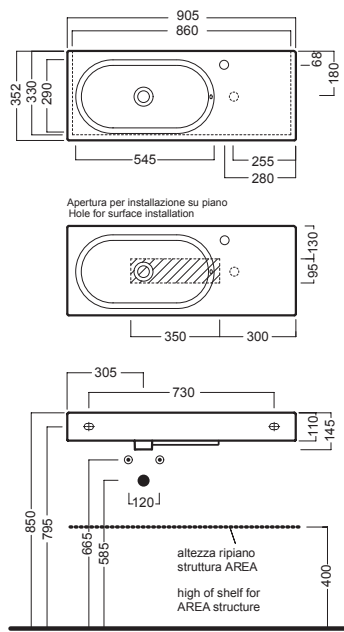

lavabo 70x35
washbasin 70x35

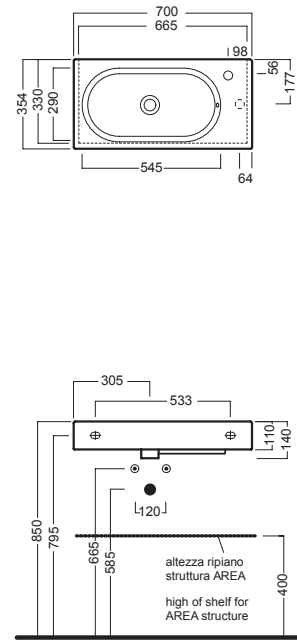

lavabo 90x45
washbasin 90x45

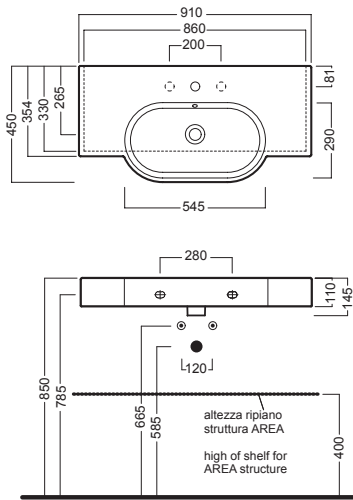

lavabo 81x45
washbasin 81x45

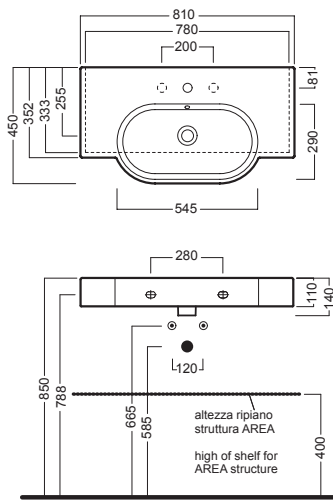

lavabo 60x45
washbasin 60x45

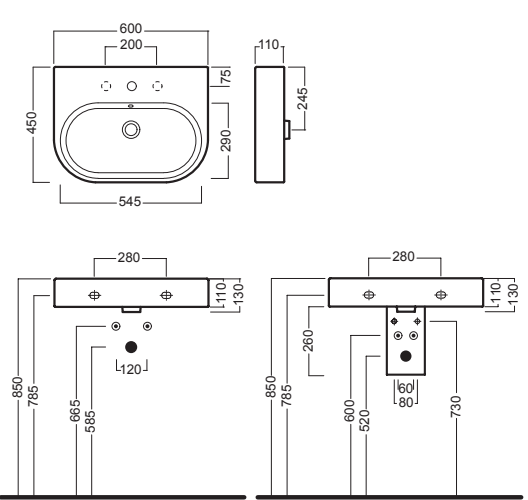

lavabo 100x35
washbasin 100x35

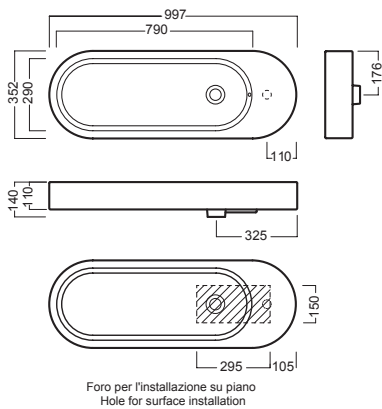

lavabo 80x35
washbasin 80x35

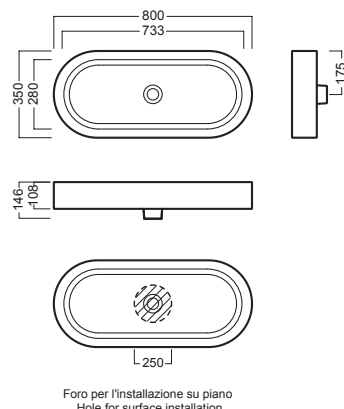

lavabo 47x47 destro
washbasin 80x35 right

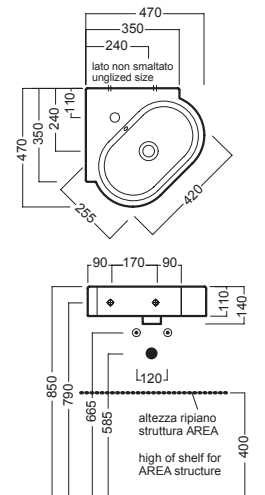

GRANDANGOLO

G-130

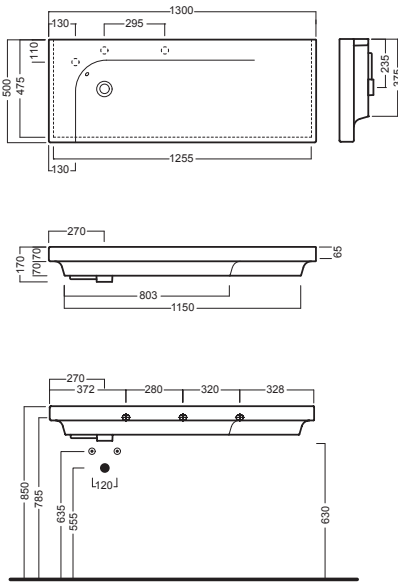

G-130 T destro
G-130 T right

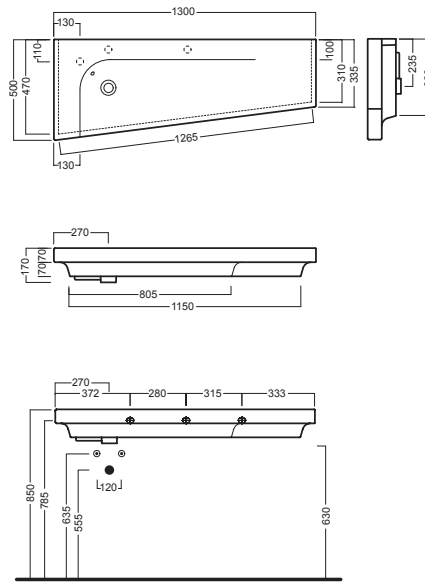

G-130 T sinistro
G-130 T left

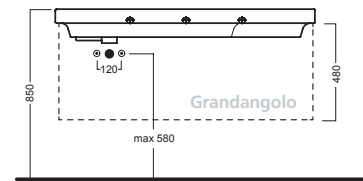
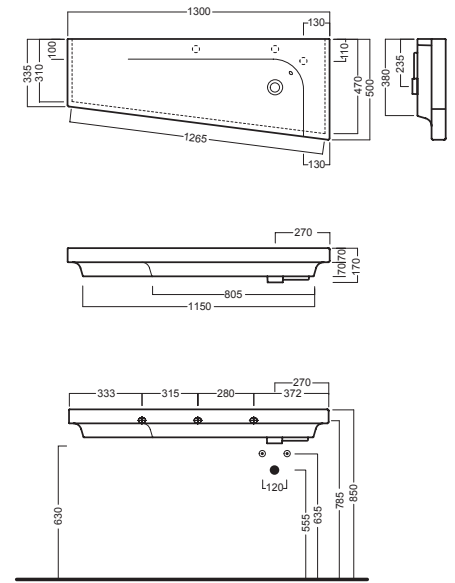

con sifone salvaspazio - with space saver trap_Y1M5

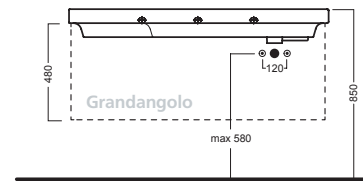

con sifone salvaspazio - with space saver trap_Y1M5

G-100

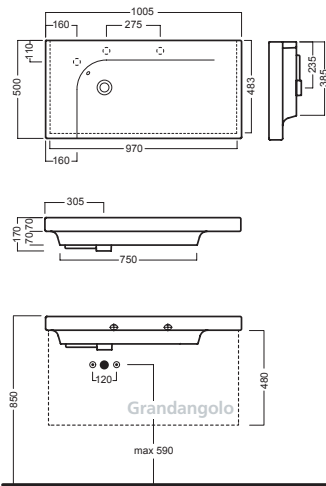

con sifone salvaspazio - with space saver trap_Y1M5

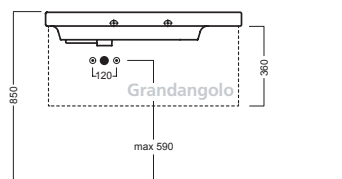

con sifone salvaspazio - with space saver trap_Y1M5

G-75 destro
G-75 right

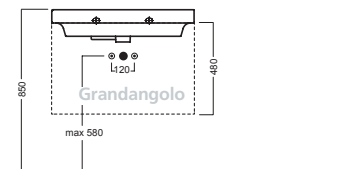
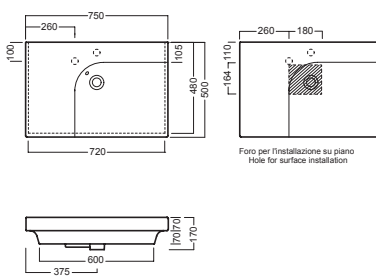

con sifone salvaspazio - with space saver trap_Y1M5

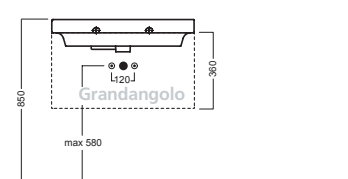

con sifone salvaspazio - with space saver trap_Y1M5

G-75 sinistro
G-75 left

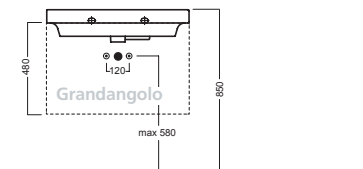
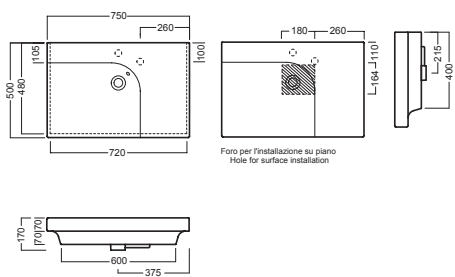

con sifone salvaspazio - with space saver trap_Y1M5

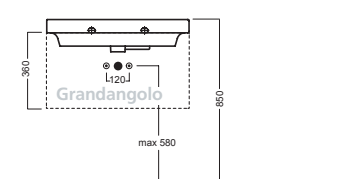

con sifone salvaspazio - with space saver trap_Y1M5

GRANDANGOLO

G-150

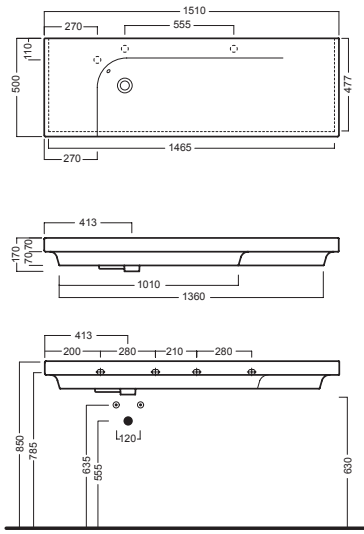

G-50 destro
G-50 right

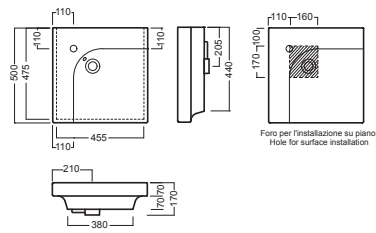

G-50 sinistro
G-50 left

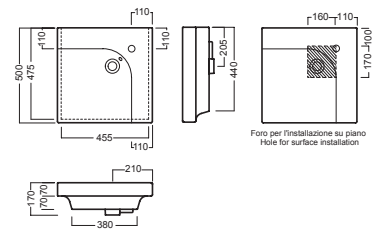

NIDO

lavabo 68
washbasin 68

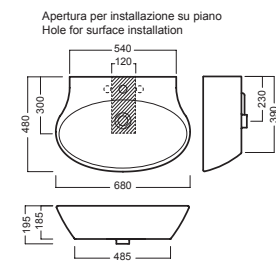

semicolonna_siphon cover

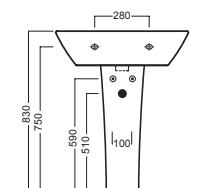

colonna_pedestal

lavabo 62
washbasin 62

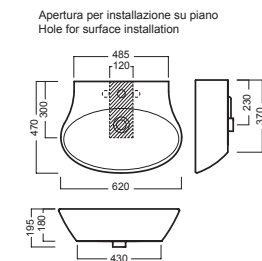

semicolonna_siphon cover

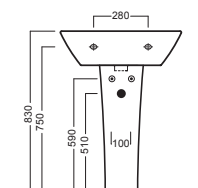

colonna_pedestal

lavabo 56
washbasin 56

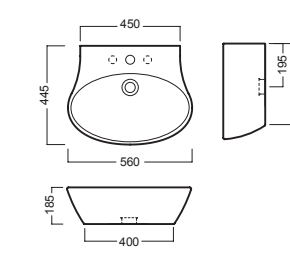

semicolonna_siphon cover

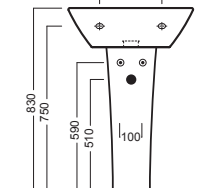

colonna_pedestal

lavabo 75 da appoggio
surface-mounted washbasin 75

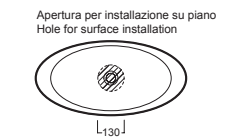
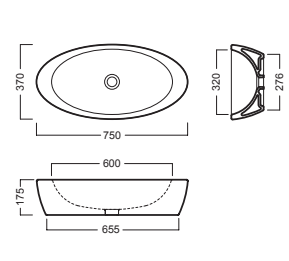

NIDO

vaso sospeso
wall hung wc

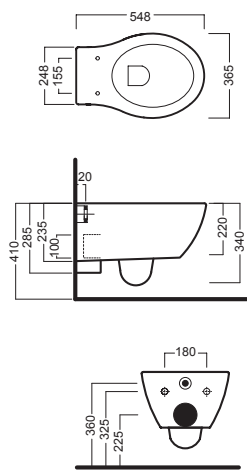

bidet sospeso
wall hung bidet

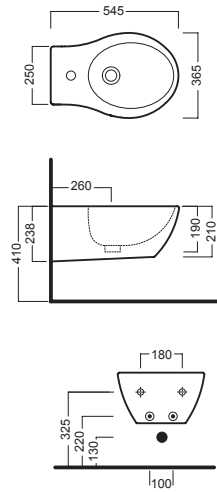

vaso filo muro
back to wall wc

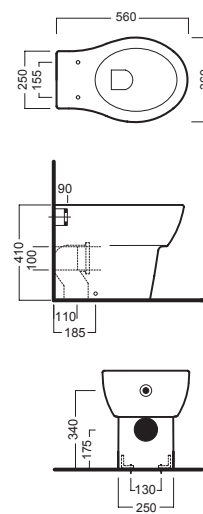

bidet filo muro
back to wall bidet

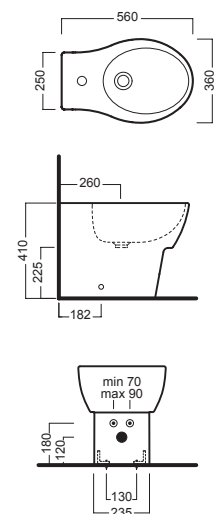

AUTONOMY

vaso monoblocco con cassetta
coupled wc with cistern

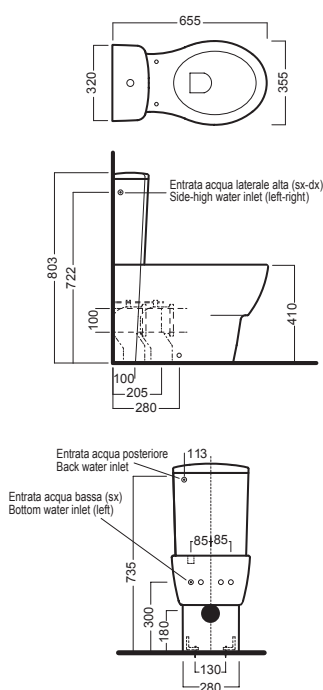

lavabo ergonomico
ergonomic washbasin

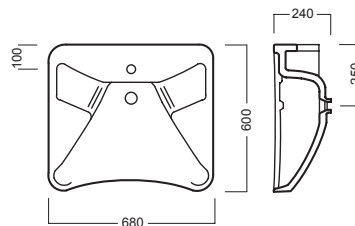

vaso con apertura frontale
wc with front opening

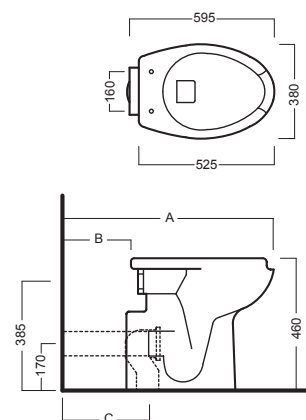

A	800	750	620
B	280	230	100
C	315	265	135

PETRA_H3 Ardesia

PETRA_h3 Ardesia 140x80

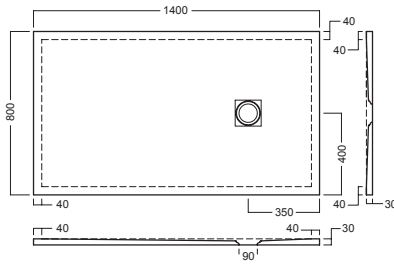

PETRA_h3 Ardesia 120x80

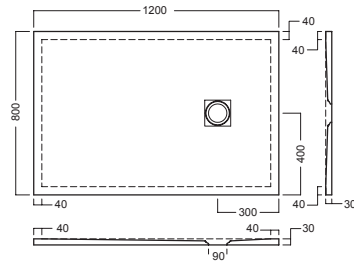

PETRA_h3 Ardesia 100x80

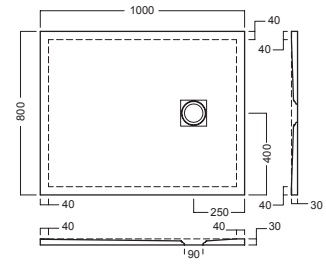

PETRA_h3 Ardesia 140x70

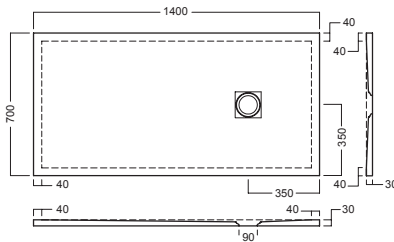

PETRA_h3 Ardesia 120x70

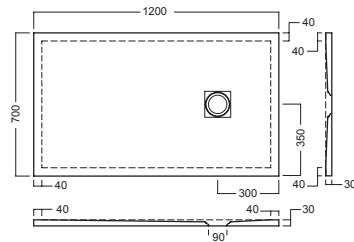

PETRA_h3 Ardesia 100x70

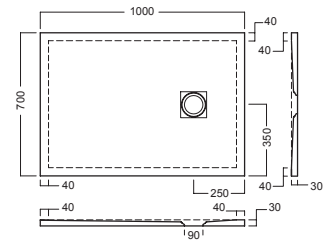

LIF showertrays H3

LIF h3 140x80_CERAMIC

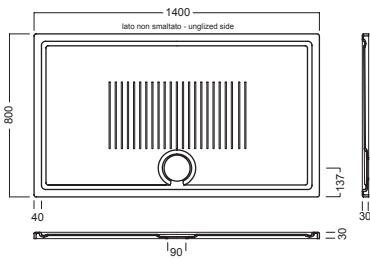

LIF h3 120x80_CERAMIC

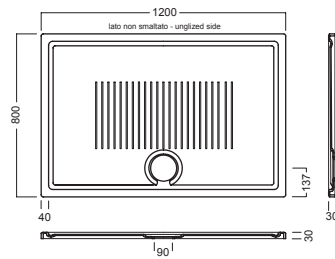

LIF h3 100x80_CERAMIC

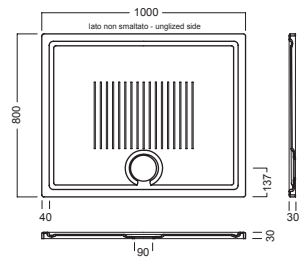

LIF h3 140x70_CERAMIC

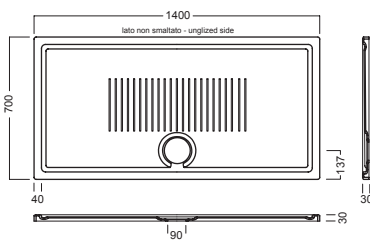

LIF h3 120x70_CERAMIC

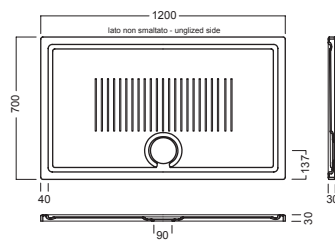

LIF h3 100x70_CERAMIC

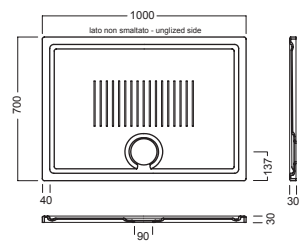

LIF h3 90x70_CERAMIC

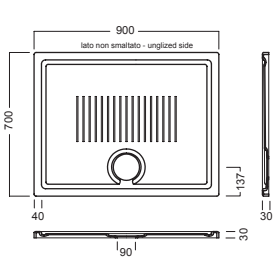

LIF h3 80x80_CERAMIC

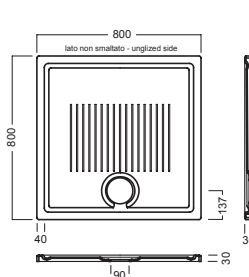

ABITO

lavabo 100
washbasin 100

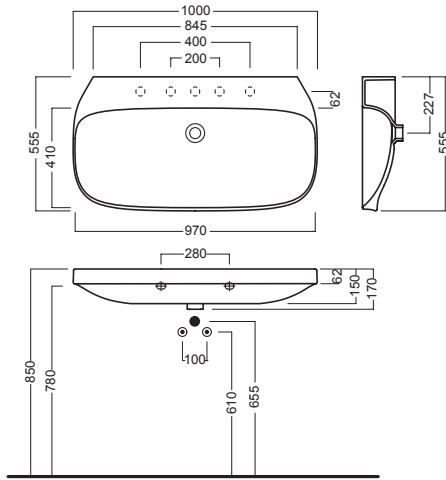

lavabo 80
washbasin 80

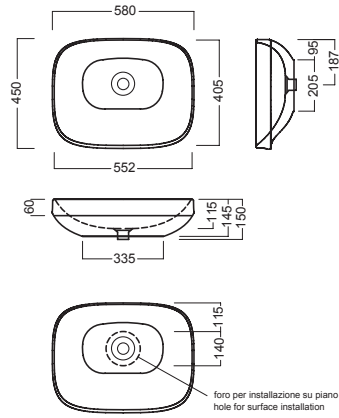

vaso sospeso
wall hung wc

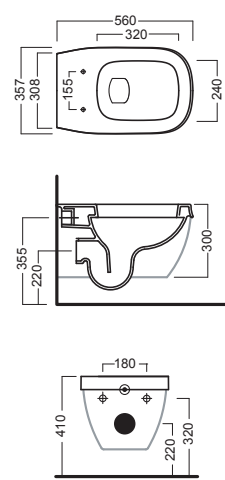

bidet sospeso
wall hung bidet

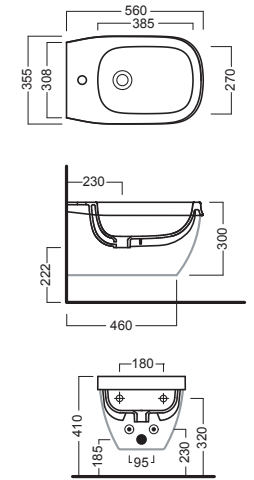

G-FULL

G-FULL 140 vaso a destra
G-FULL 140 wc right

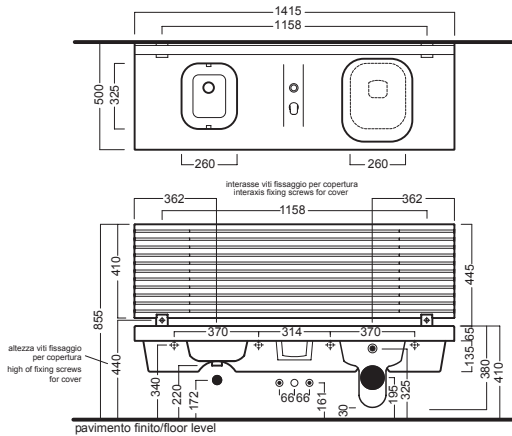

G-FULL 140 vaso a sinistra
G-FULL 140 wc left

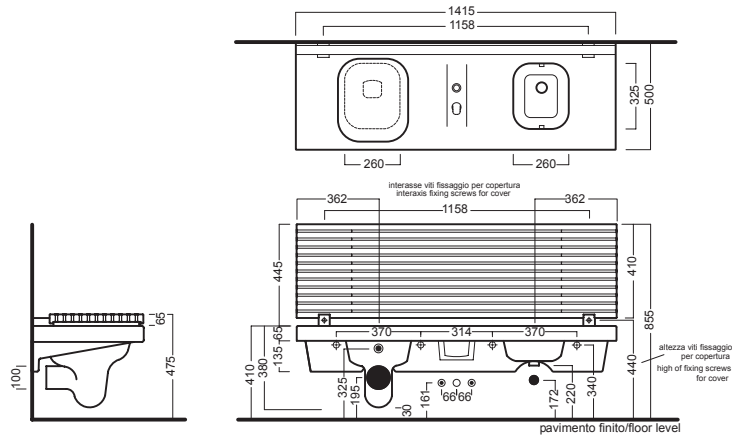

G-FULL 120 vaso a destra
G-FULL 120 wc right

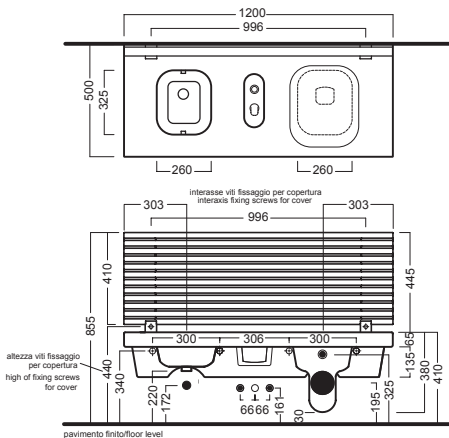

G-FULL 120 vaso a sinistra
G-FULL 120 wc left

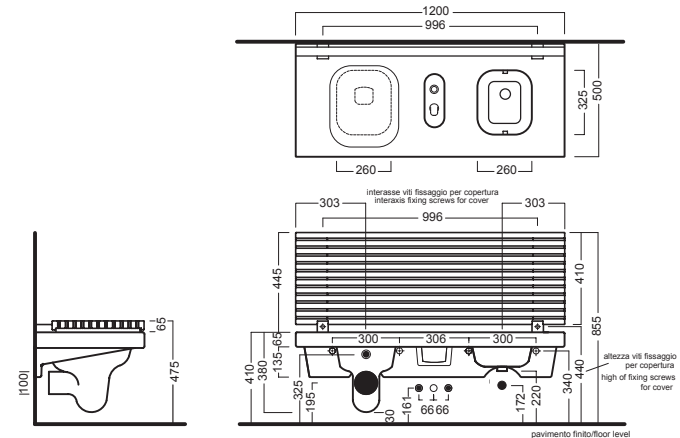

G-FULL

G-FULL 120 vaso a destra + lavabo pilozzo
G-FULL 140 wc right + sink

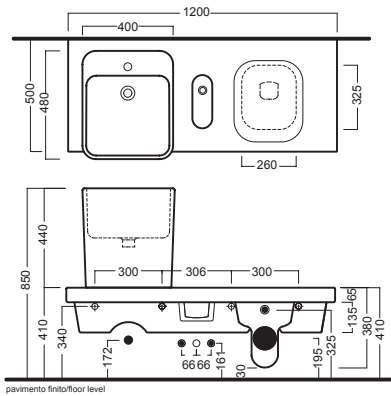

G-FULL 120 vaso a sinistra + lavabo pilozzo
G-FULL 140 wc left + sink

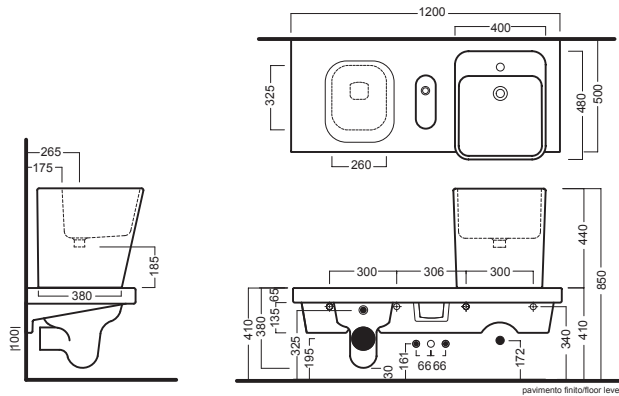

panca ad L
L bench

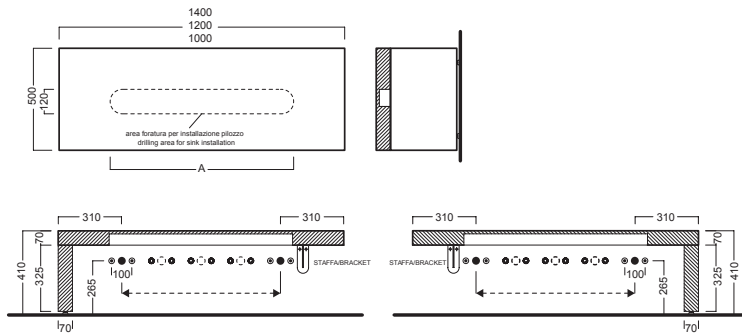

versione freestanding
freestanding version

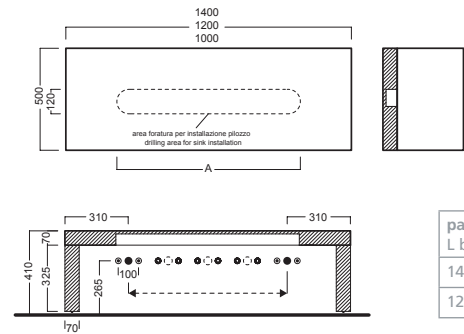

panca L L bench	A
1400	900
1200	700

lavabo pilozzo sospeso
wall hung sink

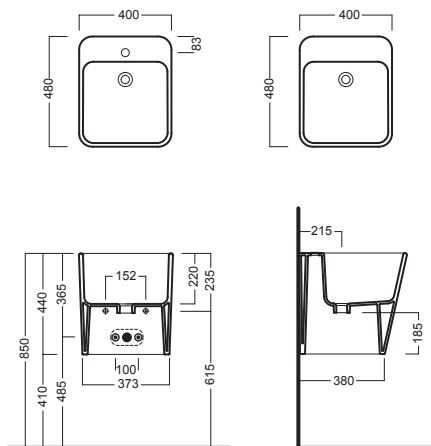

lavabo pilozzo in appoggio
surface-mounted sink

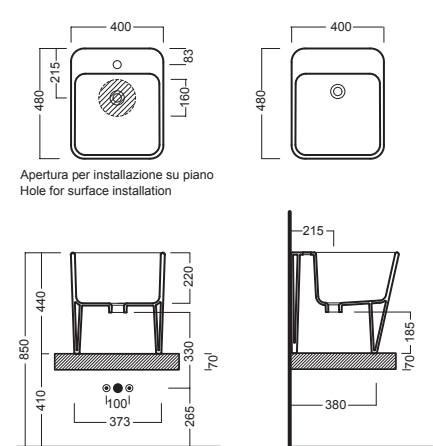

Apertura per installazione su piano
Hole for surface installation

YOU & ME

lavabo 46 destro
washbasin 92 right

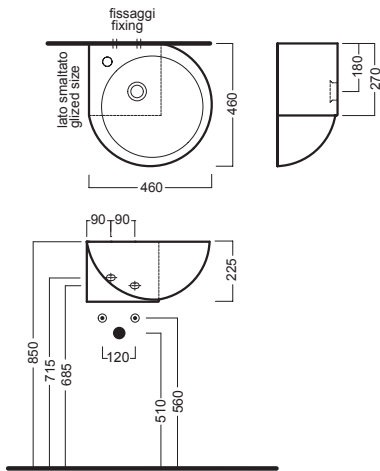

lavabo 46 sinistro
washbasin 92 left

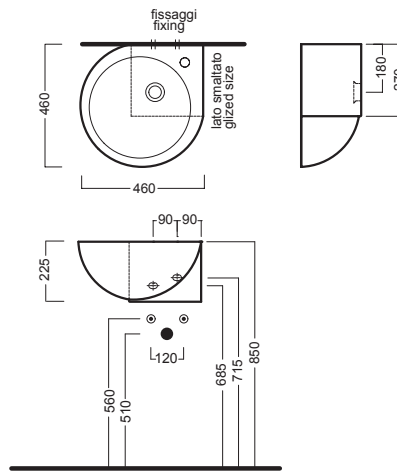

vaso d'angolo destro filo muro
back to wall right-hand corner wc

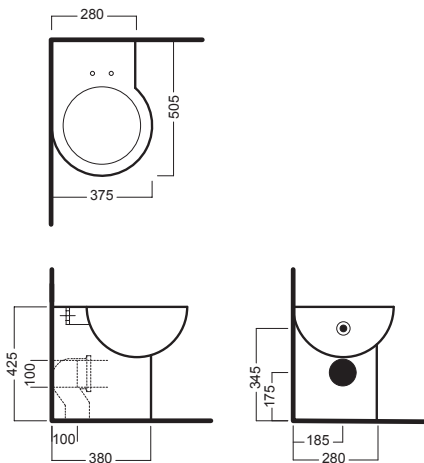

SCULTURE

vaso monoblocco con cassetta
coupled wc with cistern

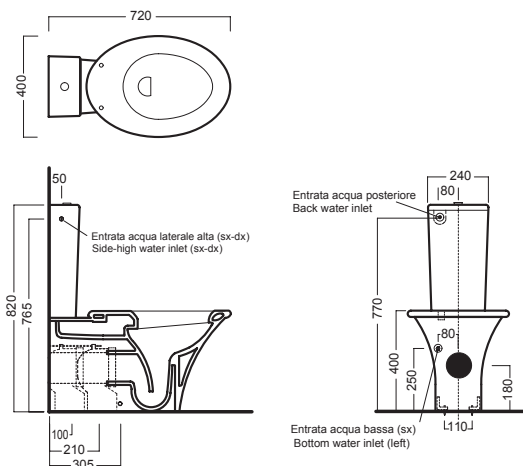

SCULTURE

lavabo 110
washbasin 110

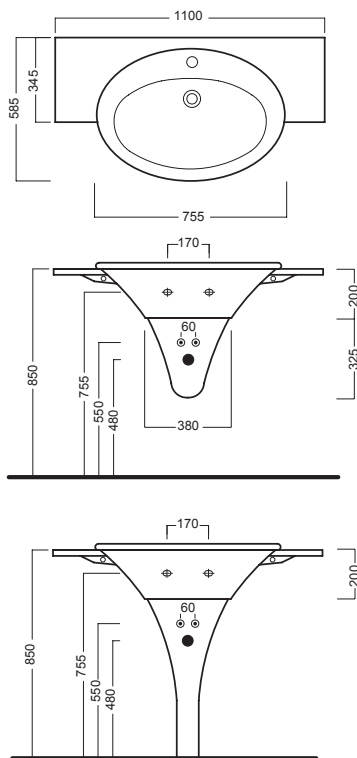

lavabo 77
washbasin 77

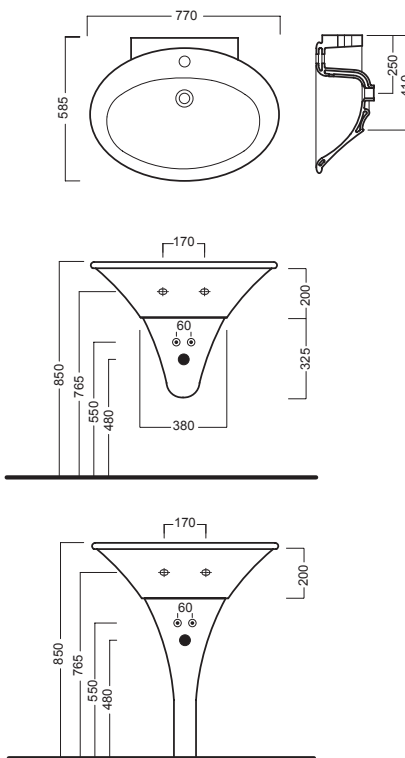

lavabo 65
washbasin 65

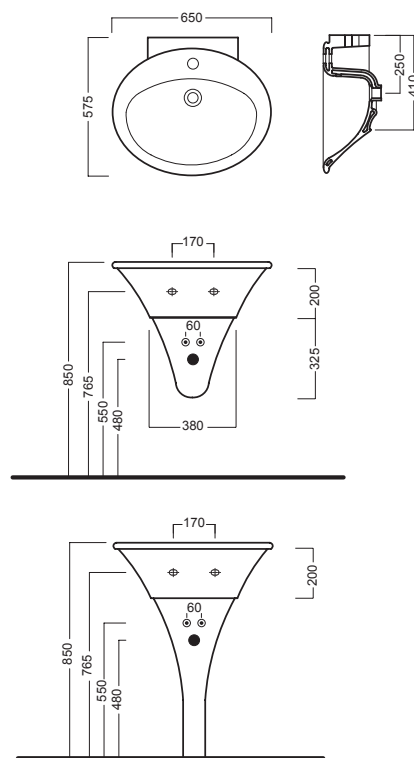

vaso sospeso
wall hung wc

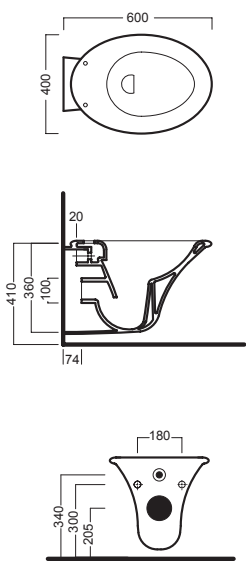

bidet sospeso
wall hung bidet

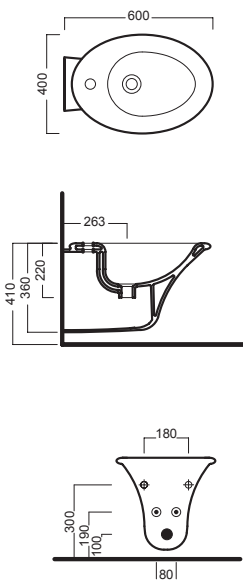

vaso filo muro
back to wall wc

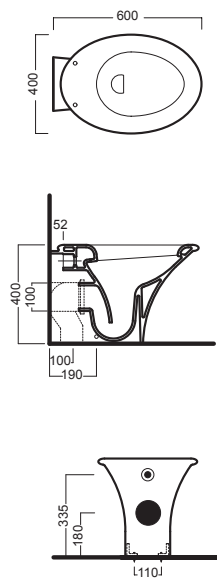

bidet filo muro
back to wall bidet

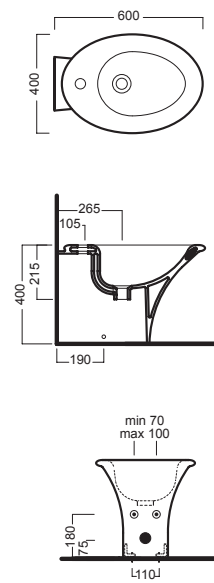

DOLCEVITA

lavabo 100
washbasin 100

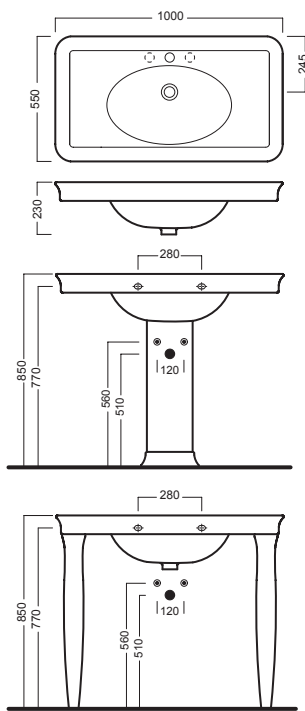

lavabo R75
washbasin R75

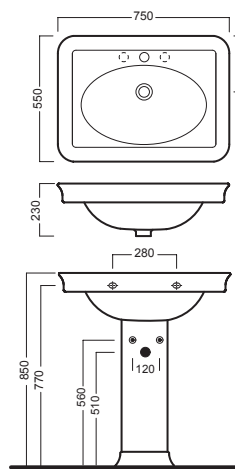

lavabo O75
washbasin O75

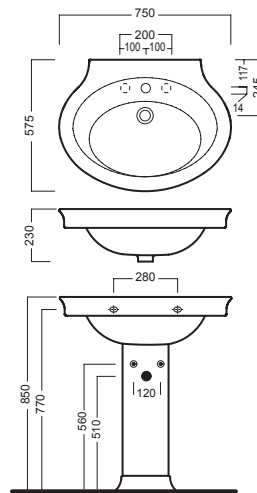

lavabo 70
washbasin 70

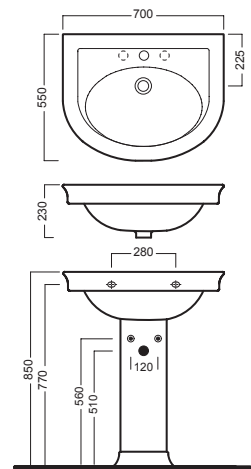

lavabo 65 ad incasso
countertop washbasin 65

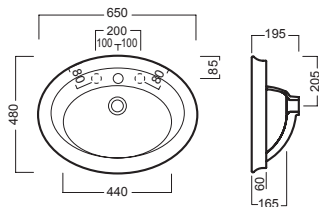

vaso scarico terra
floor outlet wc

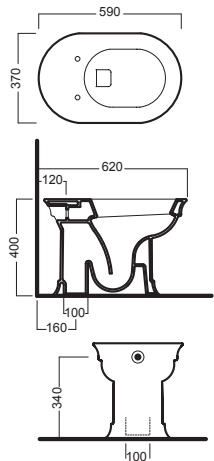

vaso scarico parete
wall outlet wc

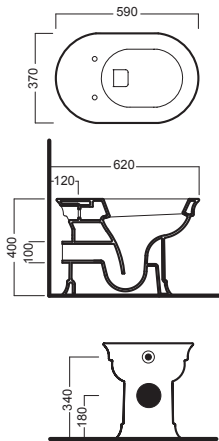

bidet monoforo
one hole bidet

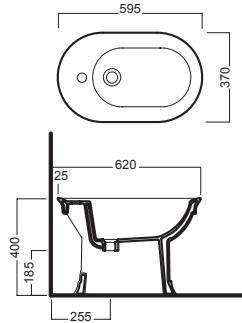

vaso scarico terra/parete + cassetta a zaino
floor/wall outlet wc + low-level cistern

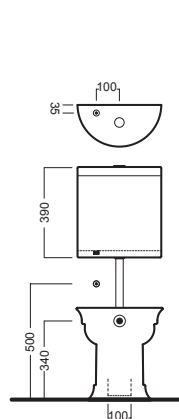
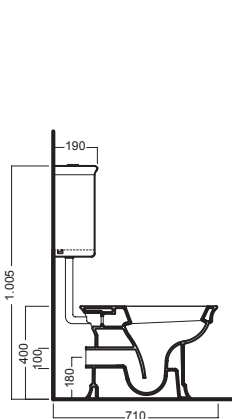
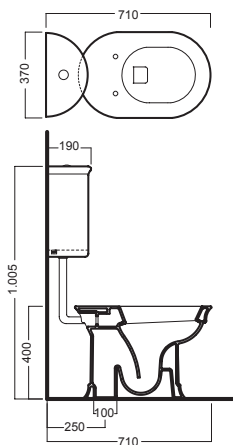

Entrata acqua bassa (sx)
Bottom water inlet (left)

SPECIALI

lavapanni SIXTY.LP
SIXTY.LP laundry sink

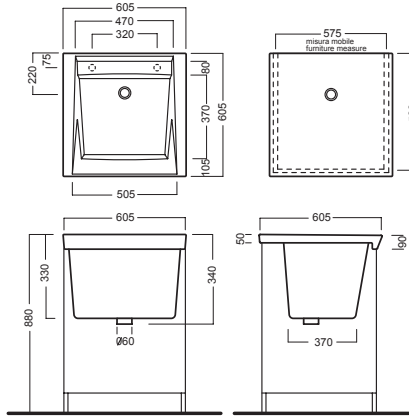

lavapanni FIFTY.LP
FIFTY.LP laundry sink

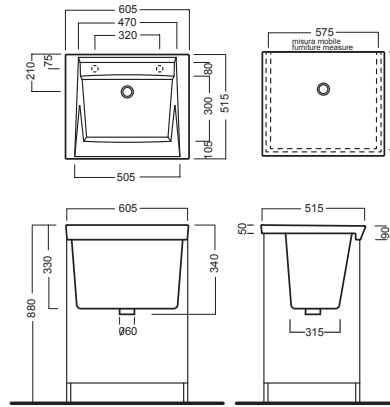

lavatoio 38
sink 38

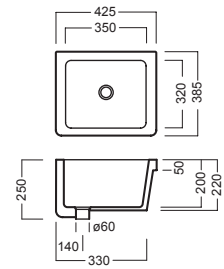

lavatoio 60
sink 60

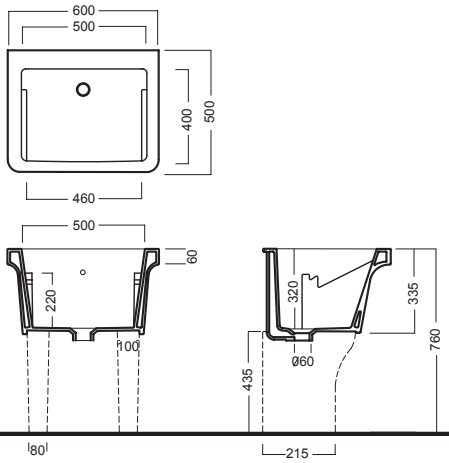

lavabo a canale 120
sink 120

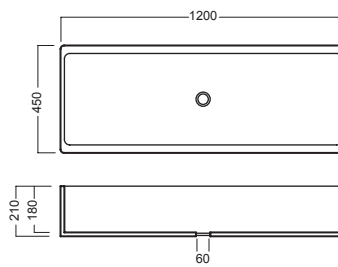

lavabo a canale 90
sink 90

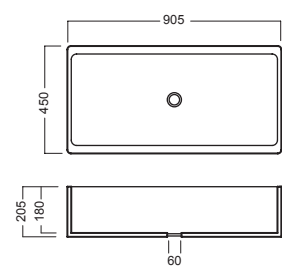

MONOLITH

cassetta attacco laterale alto dx/sx
side-high inlet right/left cistern

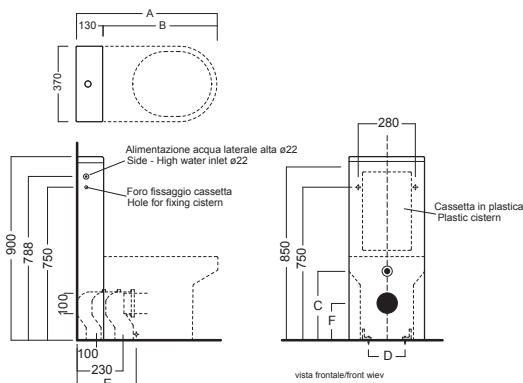

cassetta attacco posteriore
back inlet cistern

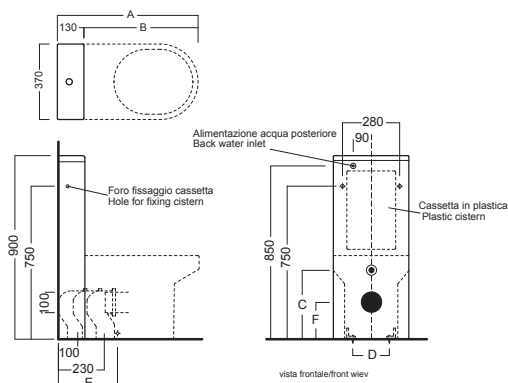

wc	A	B	C	D	E	F
FUSION	670	540	355	125	300	180
FUSION 48	610	480	360	115	290	190
NIDO	685	555	340	130	310	180
BIANCA PT	635	520	345	150	250	185
BIANCA PT TR RIM	655	520	350	165	155	180
BEAT	650	520	355	145	220	185

wc	A	B	C	D	E	F
FUSION	670	540	355	125	300	180
FUSION 48	610	480	360	115	290	190
NIDO	685	555	340	130	310	180
BIANCA PT	650	520	345	150	250	185
BIANCA PT TR RIM	655	520	350	165	225	180
BEAT	650	520	355	145	220	185

CONCEPT&GRAPHIC DESIGN

Ikos

© Copyright Hatria Srl

Stampa Gennaio 2021

8000

ABT

Hatria si riserva il diritto di apportare, in qualsiasi momento e senza preavviso, modifiche tecniche e dimensionali ai propri prodotti.
Hatria reserves the right to change the models at any moment and without notice.



hatria

Hatria S.r.l a socio unico

Via Isidoro e Lepido Facii Zona industriale S. Atto - 64020 Teramo - Italia
tel. +39 0861 2011 - fax +39 0861 201235

venditeitalia@hatria.com - exportdpt@hatria.com - marketing@hatria.com

www.hatria.com